



Elevate Accessories

Replacement Parts

Specifications and technical data are subject to change without notice.

Numbers listed in () parentheses are metric equivalents in millimeters rounded to the nearest whole number.

Suggested fasteners are not included and must be ordered separately.

Illustrations are not to scale.

Contents

Installation Accessories.....	2
Installation Accessories - Discontinued Limited Availability (LA).....	12
Installation Accessories - Discontinued No Availability (NA).....	13
Jamb Extension - Configured Parts in OMS.....	14
Jamb Extension.....	15
Jamb Extension - Discontinued No Availability (NA).....	20
Mull Kits - Casement/Awning.....	21
Mull Kits - Double Hung/Glider.....	23
Mull Kits - Double Hung Insert.....	25
Mull Kits - Doors.....	26
Certified Mull Installation Kits - Casement/Awning.....	30
Certified Mull Installation Kits - Double Hung/Glider.....	32
Certified Mull Installation Kits - Doors.....	33
Mull Kits - 1/2" Vertical MRF Mull Kit.....	34
Mull Kits - 1/2" Horizontal MRF Mull Kit.....	35
IZ3 Mull Kits - Casement.....	38
IZ3 Mull Kits - Double Hung.....	40
IZ3 Mull Kits - Doors.....	43
Mulling Parts.....	45
Mulling Parts - Discontinued Limited Availability (LA).....	54
Mulling Parts - Discontinued No Availability (NA).....	56
Miscellaneous Parts -Discontinued No Availability (NA).....	57
Exterior Casing and Parts.....	58
Exterior Casing and Parts - Discontinued Limited Availability (LA).....	63
Exterior Casing and Parts - Discontinued No Availability (NA).....	64
Repair Items.....	65
Repair Items - Discontinued No Availability (NA).....	66

Head Jamb Nailing Fin/Drip Cap (Hinged Nailing Fin Drip Cap)

V119

NOTE: Drip cap is clear

Casement and Awning		
Casement and Awning Narrow Frame*		
CN	Length	PN
17	16 1/16" (408)	16217100
21	20 1/16" (510)	16217102
25	24 1/16" (611)	16217104
29	28 1/16" (713)	16217106
33	32 1/16" (814)	16217108
37	36 1/16" (916)	16217110
41	40 1/16" (1018)	16217112
49	48 1/16" (1221)	16217114
57	56 1/16" (1424)	16217116
73	72 1/16" (1830)	16217122
17-2W	32 1/16" (814)	16217108
21-2W	40 1/16" (1018)	16217112
25-2W	48 1/16" (1221)	16217114
29-2W	56 1/16" (1424)	16217116
33-2W	64 1/16" (1627)	16217120
37-2W	72 1/16" (1830)	16217122
17-3W	48 1/16" (1221)	16217114
21-3W	60 1/16" (1526)	16217118
25-3W	72 1/16" (1830)	16217122
29-3W	84 1/16" (2135)	16217124
33-3W	96 1/16" (2440)	16217126
17-4W	64 1/16" (1627)	16217120
21-4W	84 1/16" (2135)	16217124
29-4W	144" (3658)	16217199

*Order next larger size

Double Hung		
CN	Length	PN
22	21 9/16" (548)	16217160
26	25 9/16" (649)	16217161
30	29 9/16" (751)	16217162
32	31 9/16" (802)	16217168
34	33 9/16" (853)	16217163
36	35 9/16" (903)	16217133
38	37 9/16" (954)	16217165
42	41 9/16" (1056)	16217166
48	47 9/16" (1208)	16217135
50	49 9/16" (1259)	16217169
54	53 9/16" (1361)	16217171
62	61 9/16" (1564)	16217174
22-2W	43 1/16" (1094)	16217167
26-2W	51 1/16" (1297)	16217170
30-2W	59 1/16" (1500)	16217172
32-2W	63 1/16" (1602)	15916954
34-2W	67 1/16" (1703)	16217175
36-2W	71 1/16" (1805)	16217176
38-2W	75 1/16" (1907)	16217178
42-2W	83 1/16" (2110)	16217179

Glider		
CN	Length	PN
36	35 9/16" (903)	16217133
48	47 9/16" (1208)	16217135
60	59 9/16" (1513)	16217137
72	71 9/16" (1818)	16217139
84	83 9/16" (2122)	16217140
96	95 9/16" (2427)	16217141
36-2W	71 1/16" (1805)	16217176
48-2W	95 1/16" (2415)	16217180

Inswing French Door Outswing French Door		
CN	Length	PN
2-6	30 3/8" (772)	15916926
2-8	32 3/8" (822)	15916928
3-0	36 3/8" (924)	15916931
5-0	59 1/16" (1500)	15916950
5-4	63 1/16" (1602)	15916954
6-0	71 1/16" (1805)	15916955

Sliding Patio Door Sliding French Door		
CN	Length	PN
5-0	59 1/16" (1500)	15916950
6-0	71 1/16" (1805)	15916955
7-6	88 17/32" (2249)	15916976
8-0	95 1/16" (2415)	15916981
9-0	106 17/32" (2706)	15916995

Lineal	
Length	PN
144" (3658)	16217199
192" (4879)	16217192

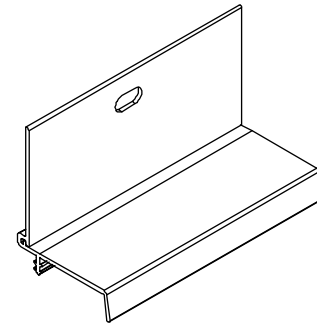

Jamb Nailing Fin

V104

Casement and Awning		
Casement and Awning Narrow Frame*		
CN	Length	PN
16	15" (381)	16217339
19	18 7/16" (468)	16217300
23	22 7/16" (570)	16217302
27	26 7/16" (672)	16217304
31	30 7/16" (773)	16217306
35	34 7/16" (875)	16217308
39	38 7/16" (976)	16217310
43	42 9/16" (1081)	16217322
47	46 7/16" (1180)	16217312
55	54 7/16" (1384)	16217314
59	58 7/16" (1484)	16217316
63	62 7/16" (1586)	16217318
71	70 7/16" (1789)	16217320

***Order next larger size**

Double Hung		
CN	Length	PN
16	14 1/2" (368)	16217816
24	22 1/2" (572)	16217924
36	34 1/2" (876)	16217836
40	38 1/2" (978)	16217840
44	42 1/2" (1080)	16217844
48	46 1/2" (1181)	16217848
52	50 1/2" (1283)	16217852
56	54 1/2" (1384)	16217856
60	58 1/2" (1486)	16217860
64	62 1/2" (1588)	16217864
68C	66 1/2" (1689)	16217868
72	70 1/2" (1791)	16217872
76	74 1/2" (1892)	16217876
80	78 1/2" (1994)	16217880
84	82 1/2" (2096)	16217884

Glider		
CN	Length	PN
24	22 1/2" (572)	16217924
36	34 1/2" (876)	16217836
42	40 1/2" (1029)	16217942
48	46 1/2" (1181)	16217848
60	58 1/2" (1486)	16217860

Sliding Patio Door Inswing French Door Outswing French Door		
CN	Length	PN
6-5	78 11/16" (1999)	15916965
6-8	81 3/16" (2062)	15916968
7-0	85 3/16" (2164)	15916970
8-0	94 11/16" (2405)	15916980

Lineal	
Length	PN
144" (3658)	16217399

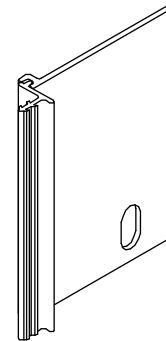

Sill Nailing Fin

V084

Casement and Awning		
Casement and Awning Narrow Frame*		
CN	Length	PN
17	16" (406)	16217200
21	20" (508)	16217202
25	24" (610)	16217204
29	28" (711)	16217206
33	32" (813)	16217208
37	36" (914)	16217210
41	40" (1016)	16217212
49	48" (1219)	16217214
57	56" (1422)	16217216
73	72" (1829)	16217222
17-2W	32" (813)	16217208
21-2W	40" (1016)	16217212
25-2W	48" (1219)	16217214
29-2W	56" (1422)	16217216
33-2W	64" (1626)	16217220
37-2W	72" (1829)	16217222
17-3W	48" (1219)	16217214
21-3W	60" (1524)	16217218
25-3W	72" (1829)	16217222
29-3W	84" (2134)	16217224
33-3W	96" (2438)	16217226
17-4W	64" (1626)	16217220
21-4W	84" (2134)	16217224
29-4W	144" (3658)	16217299

***Order next larger size**

Double Hung		
CN	Length	PN
22	21 3/8" (543)	16217201
26	25 3/8" (645)	16217203
30	29 3/8" (746)	16217205
32	31 3/8" (797)	16217207
34	33 3/8" (848)	16217209
36	35 3/8" (899)	16217211
38	37 3/8" (949)	16217213
42	41 3/8" (1051)	16217215
48	47 3/8" (1203)	16217235
50	49 3/8" (1254)	16217243
54	53 3/8" (1356)	16217244
62	61 3/8" (1559)	16217246
22-2W	42 3/4" (1086)	16217219
26-2W	50 3/4" (1289)	16217221
30-2W	58 3/4" (1492)	16217223
32-2W	62 3/4" (1594)	16217228
34-2W	66 3/4" (1695)	16217225
36-2W	70 3/4" (1797)	16217230
38-2W	74 3/4" (1899)	16217227
42-2W	82 3/4" (2102)	16217229

Glider		
CN	Length	PN
36	35 1/2" (902)	16217211
48	47 1/2" (1207)	16217235
60	59 1/2" (1511)	16217237
72	71 1/2" (1816)	16217239
84	83 1/2" (2121)	16217240
96	95 1/2" (2426)	16217241
36-2W	70 3/4" (1797)	16217230
48-2W	94 3/4" (2407)	16217248

Lineal	
Length	PN
144" (3658)	16217299

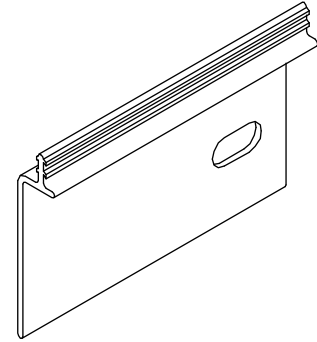

Radius Head Jamb Nailing Fin/Drip Cap

V110

Length	PN
144" (3658)	16000612

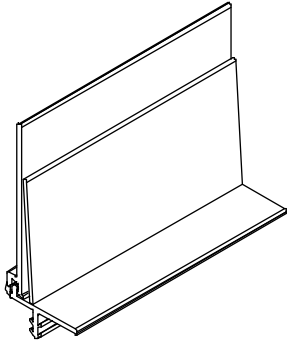

1" Frame Expander

V2034

Length	Color	PN EA	PN BX of 50
144" (3658)	Stone White	17001111	17007111
	Pebble	17002111	17008111
	Bronze	17003111	17009111
	Cashmere	17005111	17091111
	Ebony	17007211	17002311
	Gunmetal	17008811	17088111
	*Evergreen	17004111	17001011

NOTE: *DISC (LA) used prior to 10/29/2022



3" Frame Expander

V1780

Length	Color	PN EA	PN BX of 20
144" (3658)	Stone White	17001144	17001644
	Pebble	17001244	17001744
	Bronze	17001344	17001844
	Cashmere	17001544	17092044
	Ebony	17011744	17013144
	Gunmetal	17008144	17008644
	*Evergreen	17001444	17001944

NOTE: *DISC (LA) used prior to 10/29/2022

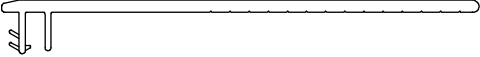

Elevate Structural Bracket

NOTE: See installation instructions included for fastener size and length.

NOTE: Replaced the masonry bracket.

Length	PN (EA)
6" (152)	11860014
10" (254)	11860009

2W2H Structural Bracket Kit - Casement		
Qty	Length	PN
8 brackets - 4 9/16"	6" (152)	11901010
8 brackets - 6 9/16" and 6 13/16"	10" (254)	11901018

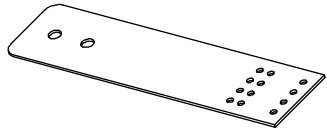

6" brackets are used on 4 9/16" jamb width.

10" brackets are used on 6 9/16" and 6 13/16"
jamb widths.

Keeper Shim

V2919

Color	PN
Black	15914511

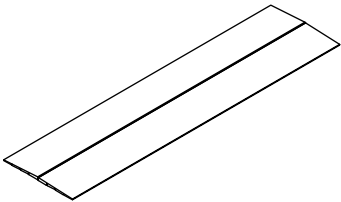

Installation Clip

NOTE: Used on Casement Picture (instructions included).

PN
11862603

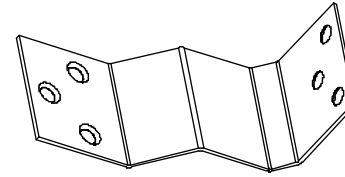

Nail Fin Installation Clip - IZ3

NOTE: Used on Casement IZ3, Casement Picture IZ3, Awning IZ3 and Direct Glaze IZ3 units.

Includes:

3 - #7 x 5/8" screws with 1 clip/45 - #7 x 5/8" screws for 15 clips
1 - Installation instructions

Qty	PN
1 clip	11896805
15 clips	11896804

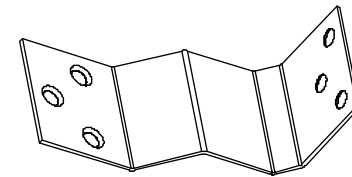

Nail Fin Installation Kit - IZ3

NOTE: Used on Double Hung IZ3 and Double Hung Picture IZ3 units.

Includes:

- 3 - #7 x 5/8" screws with 1 clip/45 - #7 x 5/8" screws for 15 clips
- 1 - Installation instructions

Qty	PN
1 clip	11896807
15 clips	11896806

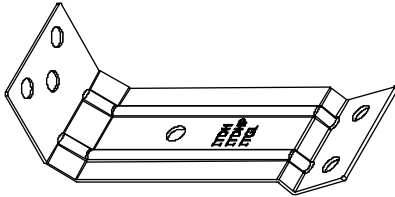

Nail Fin Installation Kit - IZ3

NOTE: Used on IZ3 Sliding French Door units

Includes:

- #7 x 5/8" screws
- Installation instructions

Qty	PN
1 clip	11896937
20 clips	11896938

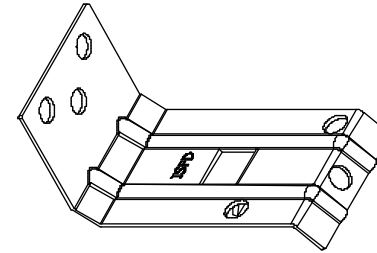

Nail Fin Installation Kit - IZ3

NOTE: Used on Sliding French Door IZ3, Outswing French Door IZ3, Door Direct Glaze Rectangle IZ3

Includes:

- 3 - #7 x 5/8" screws with 1 clip or 60 - #7 x 5/8" screws with 20 clips
- 1 - Installation instructions

Qty	PN
1 clip	11896810
20 clips	11896809

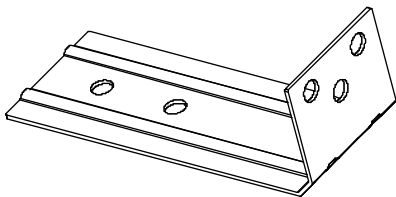

Certified Mull Structural Bracket

NOTE: See included installation instruction for fastener size and length.

Length	PN
6" (152)	11860002
10" (254)	11860003

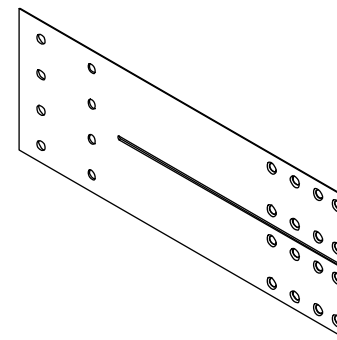

Certified Mull Clip - Sill

NOTE: Used on vertical window certified mulls. See instructions for fastener size and quantity.

PN
11861151

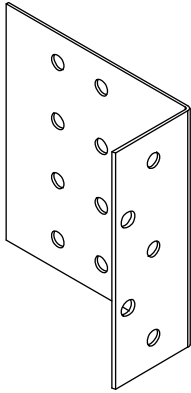

Certified Mull Clip - Jamb/Head Jamb

NOTE: Used on horizontal window certified mulls. See instructions for fastener size and quantity.

PN
11860004

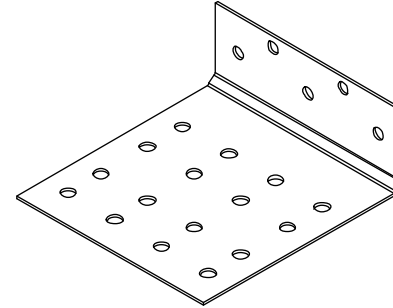

Nailing Fin Connector

Color	PN
White	10500213

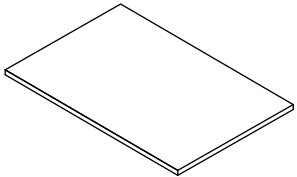

Jamb Extension Bracket

NOTE: For attaching radius jamb extension to lineal on Direct Glaze Round Top and Aluminum Direct Glaze Round Top units.

Includes:

Screws and instructions

Color	PN
White	11040353

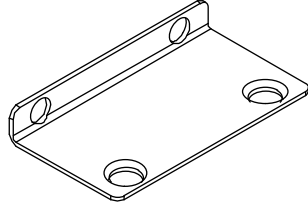

3/8" Wood Plug

Finish	PN
Bare	02074849
White	39224849
Clear	31674849
Designer Black	02072842

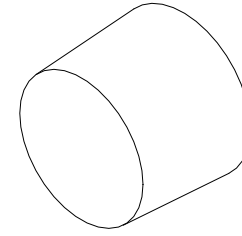

Through Jamb Installation Kit

NOTE: Used on Casement, Casement Picture, Awning and Casement Direct Glaze Rectangle

Includes:

- 1 - #8 x 3" Phillips pan head screw
- 1 - 3/8" wood plug

Finish	PN
Bare	11901031
White	11901032
Clear	33830032
Designer Black	39930032

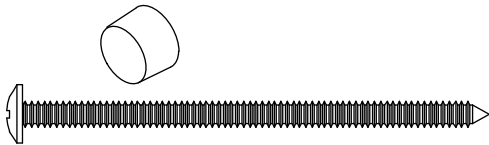

Through Jamb Installation Kit

NOTE: Used for Double Hung, Double Hung Picture, Double Hung Direct Glaze Rectangle, Glider and Glider Triple Sash

Includes:

- 1 - Installation clip
- 1 - Through jamb plug (color matched to PN color)
- 1 - #8 x 3" Phillips pan head screw
- 2 - #7 x 5/8" Phillips flat head screws

Color	PN
Beige	11901033
Stone White	11901037
Black	11901038

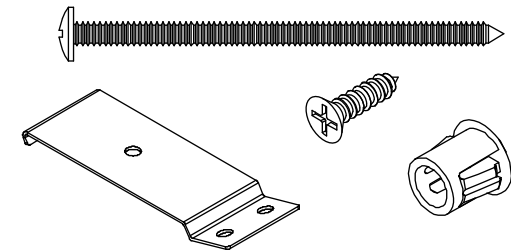

Through Jamb Installation Kit

NOTE: Used for Elevate Double Hung

Includes:

- 6 - Through jamb plugs
- 6 - #8 x 3" Phillips pan head screws

Color	PN
Beige	11896939
Stone White	11896959
Black	11896960

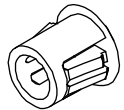

Through Jamb Screw Kit

NOTE: Used for Elevate Glider

Includes:

- 1 - #8 x 3" Phillips pan head screw
- 1 - #8 x 1 1/4" Phillips flat head screw

PN
11901035

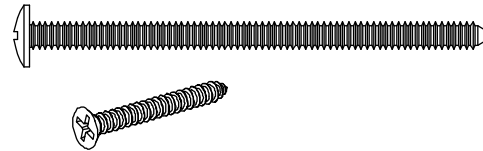

Through Jamb Plug

NOTE: Used for Elevate Double Hung, Elevate Glider and Elevate Double Hung Insert

Usage dates:

January 2006 to present

Color	PN
Beige	11882969
Black	11882971
Stone White	11882970

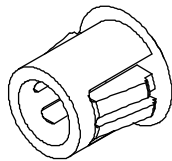

Head Jamb Nailing Fin/Drip Cap

V119

NOTE: Drip cap is clear

Description	CN	Length	PN
Patio Door (Pre 3/1/04)	6/0	72 1/16" (1830)	15916960
	9/0	108 1/16" (2745)	15916990
Sliding Door (Pre 3/1/04)	3/0	36 7/8" (937)	15916930
	6/0	72 1/16" (1830)	15916960

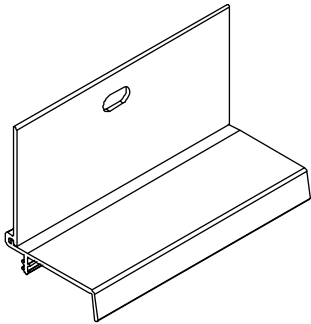

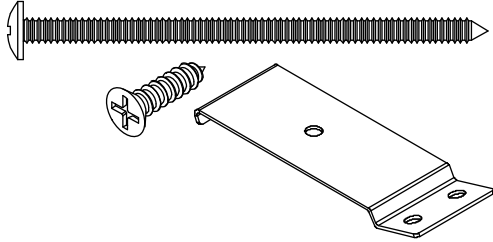

Through Jamb Installation Kit

NOTE: Used for Double Hung Picture

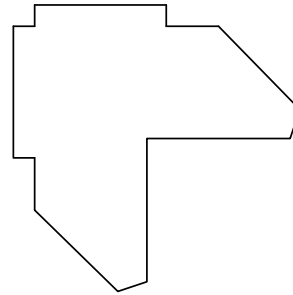

Nailing Fin Corner Gasket

No longer available.
Used prior to 10/31/2022

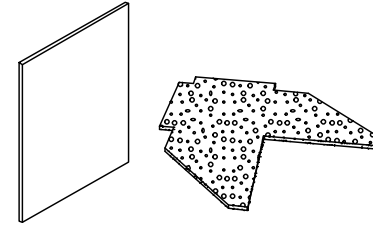

Nailing Fin Corner Gasket and Connector Gasket Kit

No longer available.
Used prior to 10/31/2022

Ordering Specifications for Configured Parts in OMS:

1. Unit type
2. Handing
3. Component
4. Exterior/interior finish
5. Unit size
6. Jamb depth
7. Component or set
8. Replacement jambs for assembly (Yes/No)

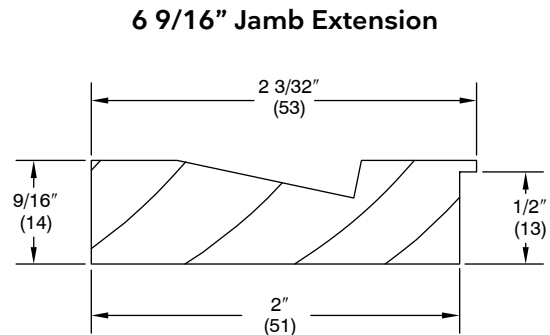

W13310

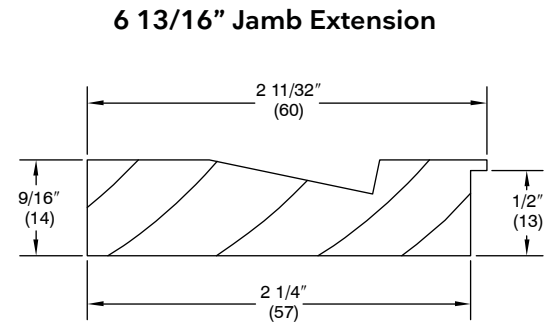

W13328

Jamb Extension - 6 9/16"

W13310

Size	CN	Bare Wood PN	White PN	Designer Black PN	Clear PN
Lineal					
120" (3048)		41501498	49201498	49901498	43831498
144" (3658)		41501499	49201499	49901499	43831499
192" (4877)		41501400	49201400	49901400	43831400
Direct Glaze Round Top and Aluminum Direct Glaze Round Top					
Radius	Quarter Cir 29-1W	41501628	49201628	49931628	43831628
	29-1W	41501614	49201614	49931614	43831614
	21-2W	41501620	49201620	49931620	43831621
	25-2W	41508015	49208015	49938015	43838015
	29-2W	41501628	49201628	49931628	43831628
	25-3W	41508016	49208016	49938015	43838016
	Casement 7318*	41501641	49201641	49930641	43830641
Aluminum Direct Glaze Round Top					
Quarter Round (RT7 & 8)	25-1W	41508015	49208015	49938015	43838015
True Half (RT1)	33-1W	41508012	49208012	49938012	43838012
True Half (RT1)	33-2W	41508076	49208076	49938076	43838076
True Half (RT1)	37-2W	41508016	49208016	49938016	43838016
True Half & True Half/Springline (RT1 & 2)	37-1W / 37W	41508013	49208013	49938013	43838013
True Half/Springline (RT2)	49W	41508015	49208015	49938015	43838015
True Half/Springline (RT2)	73W	41508016	49208016	49938016	43838016
Eyebrow/Springline (RT6)	21W / 29W	41508015	49208015	49938015	43838015
Eyebrow/Springline (RT6)	33W / 37W	41508080	49208080	49938080	43838080
Eyebrow/Springline (RT6)	41W	41508084	49208084	49938084	43838084
Eyebrow/Springline (RT6)	49W / 57W	41508017	49208017	49938017	43838017
Eyebrow/Springline (RT6)	65W / 73W	41508026	49208026	49938026	43838026

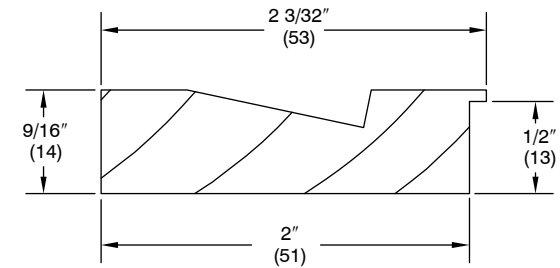

*Denotes elliptical Round Top

NOTE: Sizes without part numbers may be ordered at the next available longer length.

NOTE: If straight jamb extension is required, use the part numbers in section A

Jamb Extension - 6 9/16"

W13310

Size	CN	Bare Wood PN	White PN	Designer Black PN	Clear PN
Aluminum Direct Glaze Round Top Double Hung and Direct Glaze Round Top Double Hung DISC LA 6/28/2021					
Radius	30-1W	41501615	49201615	49931615	43831615
	34-1W	41501617	49201617	49931617	43831617
	38-1W	41501619	49201619	49931619	43831619
	34-2W	41508022	49208020	49938022	43838022
	36-2W	41508025	49208025	49938025	43838025
Aluminum Direct Glaze Round Top Double Hung/Door					
True Half (RT1)	36-1W	41508013	49208013	49938013	43838013
True Half (RT1)	42-1W	41508020	49208020	49938020	43838020
True Half (RT1)	26-2W	41508079	49208079	49938079	43838079
True Half (RT1)	30-2W	41508080	49208080	49938080	43838080
True Half (RT1)	38-2W	41508021	49208021	49938021	43838021
True Half (RT1)	42-2W	41508081	49208081	49938081	43838081
True Half above/Springline (RT2)	68W	41508022	49208022	49938022	43838022
True Half above/Springline (RT2)	72W	41508025	49208025	49938025	43838025
Eyebrow/Springline (RT6)	26W/30W	41508079	49208079	49938079	43838079
Eyebrow/Springline (RT6)	34W/36W	41508076	49208076	49938076	43838076
Eyebrow/Springline (RT6)	38W/42W	41508084	49208084	49938084	43838084
Eyebrow/Springline (RT6)	52W/60W	41508017	49208017	49938017	43838017
Eyebrow/Springline (RT6)	68W/72W	41508026	49208026	49938026	43838026
Eyebrow/Springline (RT6)	76W/84W	41508026	49208026	49938026	43838026
Quarter Round (RT7 & 8)	30W	41508080	49208080	49938080	43838080
Quarter Round (RT7 & 8)	34W	41508022	49208022	49938022	43838022
Quarter Round (RT7 & 8)	36W	41508025	49208025	49938025	43838025
Radius Jamb Extension					
Circle (RT27)	3636	41508013	49208013	49938013	43838013
Oval (RT28)	3248	41508162	49208162	49938162	43838162
Direct Glaze Round Top, Sliding Patio Door, Sliding French Door and Inswing French Door					
Radius	7218*	41501648	49201648	49930648	43830648

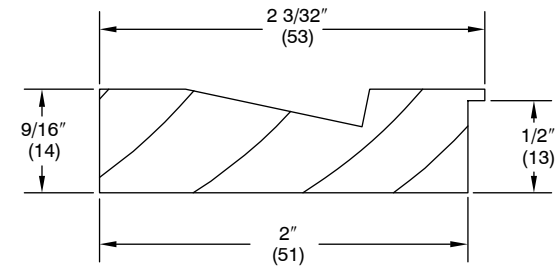

*Denotes elliptical Round Top

NOTE: Circle and Oval jamb extension requires a quantity of 2 for a complete set.

NOTE: If straight jamb extension is required, use the part numbers in section A.

Jamb Extension - 6 13/16"

W13328

Size	CN	Bare Wood PN	White PN	Designer Black PN	Clear PN
Lineal					
120" (3048)		41504098	49204098	49904098	43834098
144" (3658)		41504099	49204099	49904099	43834099
192" (4877)		41504100	49204100	49904100	43834100
Aluminum Direct Glaze Round Top Casement Direct Glaze Round Top Casement DISC LA 6/28/2021					
Radius	Quarter Cir 29-1W	41501590	49201590	49931590	43831590
	29-1W	41501587	49201587	49931587	43831587
	21-2W	41501588	49201588	49931588	43831588
	25-2W	4150811	49208110	49938110	43838110
	29-2W	41501590	49201590	49931590	13831590
	25-3W	41508111	49208111	49938111	43838111
	Casement 7318*	41501642	49201642	49930642	43830642
Aluminum Direct Glaze Round Top Casement					
Quarter Round (RT7 & 8)	25-1W	41508110	49208110	49938110	43838110
True Half (RT1)	33-1W	41508107	49208107	49938107	43838107
True Half (RT1)	33-2W	41508106	49208106	49938106	43838106
True Half (RT1)	37-2W	41508111	49208111	49938111	43838111
True Half & True Half/ Springline (RT1 & 2)	37-1W / 37W	41508108	49208108	49938108	43838108
True Half/Springline (RT2)	49W	41508110	49208110	49938110	43838110
True Half/Springline (RT2)	73W	41508111	49208111	49938111	43838111
Eye brow/Springline (RT6)	21W / 29W	41508110	49208110	49938110	43838110
Eye brow/Springline (RT6)	33W / 37W	41508148	49208148	49938148	43838148
Eye brow/Springline (RT6)	41W	41508152	49208152	49938152	43838152
Eye brow/Springline (RT6)	49W / 57W	41508112	49208112	49938112	43838112
Eye brow/Springline (RT6)	65W / 73W	41508146	49208146	49938146	43838146

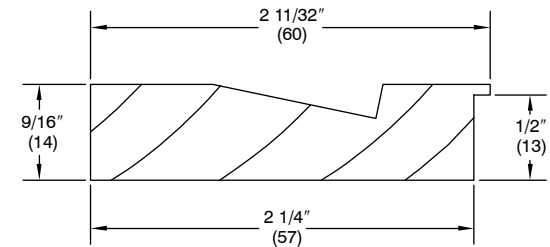

*Denotes elliptical Round Top

NOTE: If straight jamb extension is required, use the part numbers in section A

Jamb Extension - 6 13/16"

W13328

Size	CN	Bare Wood PN	White PN	Designer Black PN	Clear PN
Aluminum Direct Glaze Round Top Double Hung Direct Glaze Round Top Double Hung DISC LA 6/28/2021					
Radius	30-1W	41501593	49201593	49931593	43831593
	34-1W	41501594	49201594	49931594	43831594
	38-1W	41501595	49201595	49931595	43831595
	34-2W	41508117	49208117	49938117	43838117
	36-2W	41508145	49208145	49938145	43838145
Aluminum Direct Glaze Round Top Double Hung/Door					
True Half (RT1)	36-1W	41508108	49208108	49938108	43838108
True Half (RT1)	42-1W	41508115	49208115	49938115	43838115
True Half (RT1)	26-2W	41508147	49208147	49938147	43838147
True Half (RT1)	30-2W	41508148	49208148	49938148	43838148
True Half (RT1)	38-2W	41508116	49208116	49938116	43838116
True Half (RT1)	42-2W	41508149	49208149	49938149	43838149
True Half above/Springline (RT2)	68W	41508117	49208117	49938117	43838117
True Half above/Springline (RT2)	72W	41508145	49208145	49938145	43838145
Eye brow/Springline (RT6)	26W/30W	41508147	49208147	49938147	43838147
Eye brow/Springline (RT6)	34W/36W	41508106	49208106	49938106	43838106
Eye brow/Springline (RT6)	38W/42W	41508152	49208152	49938152	43838152
Eye brow/Springline (RT6)	52W/60W	41508112	49208112	49938112	43838112
Eye brow/Springline (RT6)	68W/72W	41508146	49208146	49938146	43838146
Eye brow/Springline (RT6)	76W/84W	41508146	49208146	49938146	43838146
Quarter Round (RT7 & 8)	30W	41508148	49208148	49938148	43838148
Quarter Round (RT7 & 8)	34W	41508117	49208117	49938117	43838117
Quarter Round (RT7 & 8)	36W	41508145	49208145	49938145	43838145
Radius Jamb Extension					
Circle (RT27)	3636	41508108	49208108	49938108	43838108
Oval (RT28)	3248	41508163	49208163	49938163	43838163
Direct Glaze Round Top, Sliding Patio Door, Sliding French Door Inswing French Door					
Radius	7218*	41501649	49201649	49930649	43830649
	7236	41508145	49208145	39938145	33838145

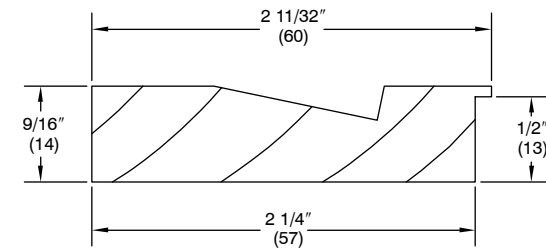

*Denotes elliptical Round Top

NOTE: Circle and Oval jamb extension requires a quantity of 2 for a complete set.

NOTE: If straight jamb extension is required, use the part numbers in section A.

1/4" Jamb Extension for 6 13/16"

W13329

Inswing French Door					
CN	Length	Bare Wood PN	White PN	Designer Black PN	Clear PN
6-0 width	71 1/4" (1810)	41502060	49202060	49902060	NA
6-8 height	69 57/64" (2029)	41502068	49202068	4990206	NA
Lineal	120" (3048)	41502120	49202120	49902120	NA
Lineal	144" (3658)	41522144	49220144	49902144	41622144

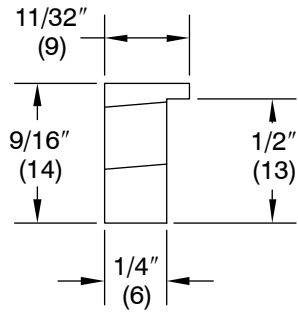

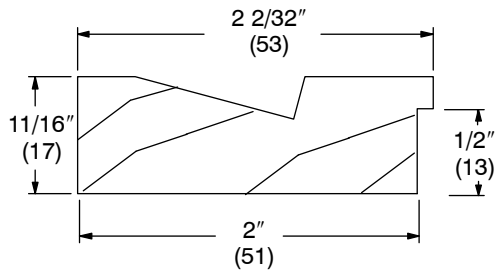

6 9/16" Jamb Extension, W7432

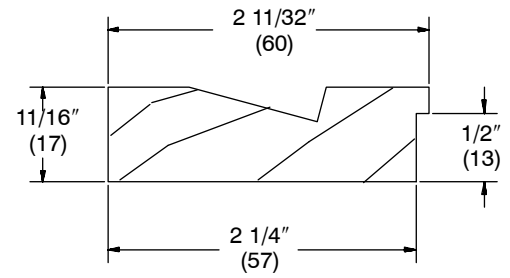

6 13/16" Jamb Extension, W7446

Mull Kits - Casement/Awning

To specify the correct part number you will need to supply width and height of the unit, configuration, interior finish and product type.

NOTE: Refer to the Mull Kit Component list section for details on what is included with each kit.

Kit	ID	Description	Size	Bare Wood PN	White PN	Designer Black PN	Clear PN
Casement/Awning Standard Mull Kit	A	19-48" (838-1219)	CN47	11898602	39258602	39938602	33838602
		49-72" (1245-1829)	CN71	11898604	39258604	39938604	33838604
		120" (3028)	120"	11898606	39258606	39938606	33838606
Casement/Awning Structural Mull Kit	B	19-48" (838-1219)	CN47	11898612	39258612	39938612	33838612
		49-72" (1245-1829)	CN71	11898614	39258614	39938614	33838614
		120" (3028)	120"	11898616	39258616	39938616	33838616
Casement DG Rectangle above Casement	C	Casement DG Rectangle above a Casement		11901011	39251011	39930011	33830011
Casement/Awning to Aluminum Direct Glaze Round Top Mull Kit	D	RT1 over Casement	96"	11897000	39257000	39937000	33837000
	E	RT7 & RT8 over/beside Casement	96"	11897002	39257002	39937002	33837002
	F	RT2 & RT6 over Casement	96"	11897004	39257004	39937004	33837004
	G	RT2 & RT6 beside Casement	120"	11897010	39257010	39937010	33837010

Component ID List Casement/Awning Mull Kits							
Component	A	B	C	D	E	F	G
Mullion Pin - A330	1	1	1	1	1	1	1
Foam Insulation	1			1	1	1	1
Mull Tape – 1 sided	1	1	1	1	1	1	1
Nail Fin Connector	2	2	2	2	2	2	2
Structural Bracket		4	4			4	
2 1/2 Mull Tin				2	2		2
3 1/2 Mull Tin			2				
V803 Connecting Barb							
W1242 Mull Trim							
W1243 Mull Trim	1	1	1	1	1	1	1
W6172 Mull Filler Block	2		2	4	4	4	4
W13003 Mull Tie	2	2	2		4	4	4
W7006 Horizontal Mull Filler Block							
W7008 Mull Reinforcement		1					

Mull Kits also include screws (where applicable), nailing fin/ drip cap and instructions.

*Profile dependent on jamb depth.

Mull Kits - Casement/Awning Narrow Frame

To specify the correct part number you will need to supply the height of the frame, exterior color and interior finish.

Components included in Kit	Description	Exterior Color	Bare Wood PN	White PN	Designer Black PN	Clear PN
Foam Tape V1213 - Recessed Exterior Mull Cover W1243 - Mull Trim Mull Tie Bracket #8-15 x 2 Phillips head full thread screw A330 Mull Trim	Casement Narrow Frame and Awning Narrow Frame Mull Kit Up to 53 3/4" frame height	Stone White	11898702	39258702	39938702	33838702
		Pebble	11898703	39258703	39938703	33838703
		Bronze	11898704	39258704	39938709	33838709
		Cashmere	11898706	39258706	39938706	33838706
		Ebony	11898708	39258708	39938708	3388708
		Gunmetal	18898708	39858708	39838708	38838708
		*Evergreen	11898705	39258705	39938705	33838705
	Casement Narrow Frame and Awning Narrow Frame Mull Kit 53 49/64" - 72" frame height	Stone White	11898812	39258812	39938812	33838812
		Pebble	11898813	39258813	39938813	33838813
		Bronze	11898814	39258814	39938814	33838814
		Cashmere	11898816	39258816	39938816	33838816
		Ebony	11898818	39258818	39938818	33838818
		Gunmetal	18898818	39858818	39838818	38838818
		*Evergreen	11898815	39258815	39938815	33838815

NOTE: *DISC (LA) used prior to 10/29/2022

Mull Kits - Double Hung/Glider

To specify the correct part number you will need to supply the width and height of the unit, the configuration, interior finish and the product type.

NOTE: Refer to the Mull Kit Component list for details on what is included with each kit.

Kit	ID	Frame Height/Width	Size	Bare Wood PN	White PN	Designer Black PN	Clear PN
Double Hung/Glider Vertical Mull Kit	A	<= to 47 3/4"	CN48	11852500	39252501	39932501	33832501
		47 3/4" to 59 3/4"	CN60	11852502	39252503	39932503	33832503
		59 3/4" to 75 3/4"	CN76	11852504	39252505	39932505	33832505
		96"	Lineal	11852506	39252507	39932507	33832507
		120"	Lineal	11852508	39252509	39932509	33832509
Double Hung Horizontal Mull Kit	B	<= to 29 1/2"	CN30	11852510	39252511	39932511	33832511
		29 1/2" to 35 1/2"	CN36	11852512	39252513	39932513	33832513
		35 1/2" to 41 1/2"	CN42	11852514	39252515	39932515	33832515
		96"	Lineal	11852516	39252517	39932517	33832517
		120"	Lineal	11852518	39252519	39932519	33832519

Component ID List Double Hung/Glider Mull Kits		
Component	A	B
Mullion Pin - A330	1	1
Mull Tape – 1 sided	1	1
Nail Fin Connector	2	2
Steel Mull Tie	1	2
W1241 Mull Trim	1	
W9159 Mull Trim		1
W8952 Mull Tie/Filler	1	1

Mull Kits also include screws (where applicable).

Mull Kits - Double Hung/Glider

To specify the correct part number you will need to supply the width and height of the unit, the configuration, interior finish and the product type.

NOTE: Refer to the Mull Kit Component list for details on what is included with each kit.

Kit	ID	Description	Size	Bare Wood PN	White PN	Designer Black PN	Clear PN
Double Hung to Round Top Mull Kit	C	Aluminum Direct Glaze Round Top RT1 over Double Hung	96"	11897006	39257006	39937006	33837006
	D	Aluminum Direct Glaze Round Top RT2 & RT6 over Double Hung		11897008	39257008	39937008	33837008
	E	Aluminum Direct Glaze Round Top RT2 & RT6 beside Double Hung		11897012	39257012	39937012	33837012
Double Hung to Polygon Mull Kit	F	Double Hung beside Polygon	Lineal	11852522	39252523	39932523	33832523
		Polygon over Double Hung					
		86" (2134)					

Component ID List Double Hung/Glider Mull Kits				
Component	C	D	E	F
Mullion Pin - A330	1	1	1	1
Mull Tape – 1 sided	1	1	1	1
Nail Fin Connector	2	2	2	2
Steel Mull Tie				2
V803 Connecting Barb				
Elevate Structural Bracket		4		
3 1/2" Mull Trim	2	2	2	
W1241 Mull Trim			1	1
W9159 Mull Trim	1	1		
W9295 Structural Mull Tie				1
W8952 Mull Tie/Filler	2	2	1	

Mull Kits also include screws (where applicable).

Mull Kits - Double Hung Insert

To specify the correct part number you will need to supply the height of the frame, exterior color and interior finish.

Components included in Kit	Description	Exterior Color	Interior Finish and Part Numbers			
			Bare Wood	White	Designer Black	Clear
A330 - Mulling Pin Foam Tape V2316 - Exterior Mull Cover W11965 - Vertical Mull Trim Vertical Mull Foam Filler	Double Hung Insert Vertical Mull Kit, 48CN 16" - 48" frame height	Stone White	11853002	11853004	11853118	11853101
		Pebble	11853006	11853008	11853121	11853104
		Bronze	11853010	11853012	11853124	11853107
		Cashmere	11853018	11853020	11853131	11853113
		Ebony	11853023	11853025	11853133	11853116
		Gunmetal	11883023	11883025	11883133	11883116
		*Evergreen	11853014	11853016	11853127	11853110
	Double Hung Insert Vertical Mull Kit, 60CN 48 1/64" - 60" frame height	Stone White	11853026	11853028	11853119	11853102
		Pebble	11853030	11853032	11853122	11853105
		Bronze	11853034	11853036	11853125	11853108
		Cashmere	11853042	11853044	11853131	11853114
		Ebony	11853047	11853049	11853134	11853117
		Gunmetal	11883047	11883049	11883134	11883117
		*Evergreen	11853038	11853040	11853128	11853111
	Double Hung Insert Vertical Mull Kit, Lineal 60 1/64" - 84" frame height	Stone White	11853050	11853052	11853120	11853103
		Pebble	11853054	11853056	11853123	11853106
		Bronze	11853058	11853060	11853126	11853109
		Cashmere	11853066	11853068	11853132	11853115
		Ebony	11853071	11853073	11853135	11853136
		Gunmetal	11883071	11883073	11883135	11883136
		*Evergreen	11853062	11853064	11853129	11853112

NOTE: *DISC (LA) used prior to 10/29/2022

Mull Kits - Doors

To specify the correct part number you will need to supply the width and height of the unit, the configuration, interior finish and the product type.

NOTE: Refer to the Mull Kit Component list for details on what is included with each kit.

NOTE: Specific mull kits are required when mulling Inswing Doors with 6 9/16" jamb extension to an Direct Glaze or Aluminum Direct Glaze Round Top, see below.

Vertical Mull Kit						
Kit ID	Description	Exterior Color	Interior Finish and Part Number			
			Bare Wood	White	Designer Black	Clear
A	Inswing French Door to Sliding French Door - 96"	-	11898642	39258642	39938642	33838642
B	Outswing French Door to Outswing French Door - 96"	-	11893751	39203751	39938651	33838651
	Outswing French Door to Sliding French Door - 96"	-	11893753	39203753	39938653	33838653
C	Inswing French Door to Inswing French Door - 96" Outswing French Door G3 to Outswing French Door G3	Stone White	11893754	39203777	39933877	33833877
		Pebble Gray	11893755	39203778	39933878	33833878
		Bronze	11893756	39203779	39933879	33833879
		Cashmere	11893758	39203781	39933881	33833881
		Ebony	11893760	39203783	39933883	33833883
		Gunmetal	18893760	39803783	39833883	38833883
		*Evergreen	11893757	39203780	39933880	33833880

Component ID List Doors			
Component	A	B	C
Mullion Pin - A330	1	1	1
Mull Tape – 1 sided	1	1	1
Nail Fin Connector	2	2	1
3 1/2" Mull Tin	1	1	1
Sill Bracket	1	2	1
W1241 Mull Trim	1	1	1
V1407 Euro Groove Block		1	
V1213 Exterior Mull Cover			1

NOTE: *DISC (LA) used prior to 10/29/2022

Mull Kits - Doors

To specify the correct part number you will need to supply the width and height of the unit, the configuration, interior finish and the product type.

NOTE: Refer to the Mull Kit Component list for details on what is included with each kit.

NOTE: Specific mull kits are required when mulling Inswing Doors with 6 9/16" jamb extension to a Direct Glaze or Aluminum Direct Glaze Round Top, see Kit K below.

Kit ID	Description	Interior Finish and Part Numbers			
		Bare Wood	White	Designer Black	Clear
Vertical/Horizontal Mull Kit - 84"					
D	Direct Glaze or Polygon over or beside Inswing French Door or Outswing French Door - 4 9/16"	11901005	39251005	39930005	33830005
	Direct Glaze or Polygon over or beside Inswing French Door or Outswing French Door - 6 9/16"	11901012	39251012	39930012	33830012
Horizontal Mull Kit					
E	Double Hung Direct Glaze Rectangle over Sliding Patio Door, Sliding French Door, Inswing French Door or Outswing French Door - 96"	11901009	39251009	39930009	33830009
F	Double Hung Direct Glaze Rectangle over Sliding Patio Door, Sliding French Door, Inswing French Door or Outswing French Door - 71"	11901013	39251013	39930013	33830013
G	Direct Glaze Rectangle (1W, 2W, or 3W) over Sliding Patio Door, Sliding French Door, Inswing French Door, Outswing French Door	11901016	39251016	39930016	33830016
H	Direct Glaze (RO 37.319 x 16.250) over 3-0 Wide Outswing French Door G3, Inswing French Door	11901006	39251006	39930006	33830006

Component ID List Doors					
Component	D	E	F	G	H
A330, Mullion Pin	1	1	1	2*	1
Mull Tape, 1 sided	1	1	1	1	1
Nail Fin Connector	2	2	2	2	1
3 1/2" Mull Tin	2	2	2	2	2
Structural Bracket	4	4	4	4	4
W1241, Mull Trim	1	1	1	2	1

*Included with kit is one lineal length (horizontal) and one 71 1/2" length (vertical).

Mull Kits - Doors

To specify the correct part number you will need to supply the width and height of the unit, the configuration, interior finish and the product type.

NOTE: Refer to the Mull Kit Component list for details on what is included with each kit.

NOTE: Specific mull kits are required when mulling Inswing Doors with 6 9/16" jamb extension to an Direct Glaze or Aluminum Direct Glaze Round Top, see below.

Kit ID	Description	Interior Finish and Part Number			
		Bare Wood	White	Designer Black	Clear
Round Top Mull Kit					
I	Aluminum Direct Glaze Round Top RT2 or RT6 over Sliding Patio Door, Sliding French Door, Inswing French Door, Outswing French Door - 4 9/16" - 96"	11897014	39257014	39937014	33837014
J	Aluminum Direct Glaze Round Top RT2 or RT6 over Inswing French Door with 6 9/16" jamb extension	11897016	39257016	39937016	33837016

Component ID List Doors		
Component	I	J
Mullion Pin - A330	1	1
Mull Tape – 1 sided	1	1
Nail Fin Connector	2	2
Connecting Barb		
3 1/2" Mull Tin	2	2
Structural Bracket	4	4
W1241 Mull Trim		1
W1242 Mull Trim	1	
W9431 Mull Filler		1

Installation Kits - Doors

NOTE: Refer to the Mull Kit Component list for details on what is included with each kit.

Kit ID	Description	PN
A	Primary Installation Kit (All units - qty 1)	11051702
B	Knock-Down Frame Assembly Kit (All KD Assemblies)	11051703

Assembled Unit Kit Quantities							
	O	OO	X	XX	OXL/XOR	XOL/OXR	OXO
Primary Installation Kit	1	1	1	1	1	1	1
Panel Screw Kit*	0	0	2	4	2	0	0
Knock-down Unit Kit Quantities							
Primary Installation Kit	1	1	1	1	1	1	1
Panel Screw Kit*	0	0	5	10	5	7	7
Stationary Lock Bar	0	1	0	0	1	1	2
Knock-down Frame Assembly Kit	1	1	1	1	1	1	1

Certified Mull Kits - Casement/Awning

To specify the correct part number you will need to supply the configuration and product type.

NOTE: If ordering for a field applied mull, you will also need to order the appropriate mull kit for the product being mulled. See table of contents for available mull kits.

NOTE: Refer to the Mull Kit Component list for details on what is included with each Certified Mull Installation Accessory Kit.

Kit	ID	Description	Size	PN
Casement/Awning Certified Mull Installation Accessory Kit	A	Vertical Clip Install		11891124
	B	Horizontal Clip Install		11891125
	C	Masonry Install	6"	11891126
	D	Masonry Install	10"	11891127

Component ID List Casement/Awning				
Component	A	B	C	D
Mull Clip - Sill	2			
Mull Clip - Jamb/Head Jamb	2	4		
6" Structural Mull Bracket			4	
10" Structural Mull Bracket				4
1.25" Screws	32	32	32	32
2.5" Screws	5	5	5	5

Certified Mull Kits - Casement/Awning

To specify the correct part number you will need to supply the configuration and product type.

NOTE: If ordering for a field applied mull, you will also need to order the appropriate mull kit for the product being mullled. See table of contents for available mull kits.

NOTE: Refer to the Mull Kit Component list for details on what is included with each Certified Mull Installation Accessory Kit.

Kit	ID	Description	Size	PN
Aluminum Direct Glaze Round Top over Casement/Awning Certified Mull Installation Accessory Kit	A	Vertical Clip Install		11891137
	B	Horizontal Clip Install		11891138
	C	Masonry Install	6"	11891139
	D	Masonry Install	10"	11891140

Component ID List Aluminum Direct Glaze Round Top over Casement/Awning				
Component	A	B	C	D
Mull Clip - Sill	2			
Mull Clip - Jamb/Head Jamb		2		
6" Structural Mull Bracket			2	
10" Structural Mull Bracket				2
Elevate Casement Installation Clip	6	6		
6" Structural Bracket			6	
10" Structural Bracket				6
5/8" Screws	18	18		
1 1/4" Screws	16	16	28	28

Certified Mull Kits - Double Hung/Glider

To specify the correct part number you will need to supply the configuration and product type.

NOTE: If ordering for a field applied mull, you will also need to order the appropriate mull kit for the product being mulled. See table of contents for available mull kits.

NOTE: Refer to the Mull Kit Component list for details on what is included with each Certified Mull Installation Accessory Kit.

Kit	ID	Description	Size	PN
Double Hung/Glider Certified Mull Installation Accessory Kit	A	Vertical Clip Install		11891120
	B	Horizontal Clip Install		11891121
	C	Masonry Install	6"	11891122
	D	Masonry Install	10"	11891123

Component ID List Double Hung/Glider				
Component	A	B	C	D
Mull Clip - Sill	2			
Mull Clip - Jamb/Head Jamb	2	4		
6" Structural Mull Bracket			4	
10" Structural Mull Bracket				4
5/8" Screws	32	32	32	32

Certified Mull Kits - Doors

To specify the correct part number you will need to supply the configuration and product type.

NOTE: If ordering for a field applied mull, you will also need to order the appropriate mull kit for the product being mulled. See table of contents for available mull kits.

NOTE: Refer to the Mull Kit Component list for details on what is included with each Certified Mull Installation Accessory Kit.

Kit	ID	Description	Size	PN
Outswing French Door, Sliding Patio Door, Sliding French Door Certified Mull Installation Accessory Kit	A	Vertical Clip Install		11891128
	B	Vertical Masonry Install	6"	11891129
	C	Vertical Masonry Install	10"	11891130
Inswing French Door Certified Mull Installation Accessory Kit	D	Vertical Clip Install		11891131
	E	Vertical Masonry Install	6"	11891132
	F	Vertical Masonry Install	10"	11891133
Inswing French Door, Outswing French Door, Sliding Patio Door, Sliding French Door Certified Mull Installation Accessory Kit	G	Horizontal Clip Install		11891134
	H	Horizontal Masonry Install	6"	11891135
	I	Horizontal Masonry Install	10"	11891136
Outswing French Door G3	J	Horizontal Clip Install		11891141
	K	Horizontal Masonry Install	6"	11891142
	L	Horizontal Masonry Install	10"	11891143

Component ID List Doors												
Component	A	B	C	D	E	F	G	H	I	J	K	L
Mull Clip - Jamb/Head Jamb - 11860004				2			4			6		
6" Structural Mull Bracket - 11860002					2			4			6	
10" Structural Mull Bracket - 11860003						2			4			6
Elevate Outswing French Door Mull Clip - 11862512	1											
6" Structural Bracket (IZ3) - 11862513		1										
10" Structural Bracket (IZ3) - 11862514			1									
5/8" Screws - 11800758	16	16	16	16	16	16	32	32	32	48	48	48

Mull Kits - 1/2" Vertical MRF Mull Kit

To specify the correct part number you will need to supply the height of the frame, exterior color and interior finish.

	Exterior Color	Interior Finish and Part Number			
		Bare Wood	White	Designer Black	Clear
1/2" Vertical MRF Mull Kit Double Hung, Glider, Double Hung Direct Glaze Rectangle	Stone White	11891220	11891221	11891309	11891308
	Pebble	11891222	11891223	11891311	11891310
	Bronze	11891224	11891225	11891313	13891312
	Cashmere	11891226	11891227	13891315	13891314
	Ebony	11891219	11891218	13891319	13891318
	Gunmetal	18891219	18891218	18891319	18891318
	*Evergreen	11891228	11891229	13891317	13891316

NOTE: *DISC (LA) used prior to 10/29/2022

Components for 1/2" Vertical MF Mull Kits - Lineal parts for kits are 96" long		
Description	Base Kit Qty	Extra Quantities Needed for Additional Mulling
End Plug, 1/2" Space Mull - PN 11860389	2 per kit	2 extra plugs ordered separately per additional mull
A3134 Mulling Pin, 1/2" Space Mull	2 per kit	
V2789 Mull Weather Strip, 1/2"	1 per kit	
PUR w/1 1/2" Tape	1 per kit	
V2787 Mull Cover (w/Glazing Tape)	1 per kit	
Center Plug - PN 11860388	1 per kit	1 extra plug ordered separately per additional mull (when required)
W12870 Mull Support	1 per kit	
W1242 Mull Trim	1 per kit	
Mull Bracket PN - 11040358	1 per kit	
#7-19 x 5/8" Bracket Screw PN - 11800743	36 per kit	36 extra screws needed per additional mull
#8 x 1 3/4" End Plug Screw PN - 11808176	2 per kit	2 extra screws needed per additional mull
V119 Continuous Drip Cap	1 per kit	For assemblies wider than 96", special parts are required
Nailing Fin Connector PN - 10500213	2 per kit	2 extra connectors are required per additional mull

Mull Kits - 1/2" Horizontal MRF Mull Kit

To specify the correct part number you will need to supply the height of the frame, exterior color and interior finish.

1/2" Horizontal MRF Mull Kit Double Hung, Picture, Direct Glaze Rectangle, Aluminum Direct Glaze Round Top (Double Hung) above mull				
Exterior Color	Interior Finish and Part Number			
	Bare Wood	White	Designer Black	Clear
Stone White	11891255	11891244	13891321	13891320
Pebble	11891245	11891246	13891323	13891322
Bronze	11891247	11891248	13891325	13891324
Cashmere	11891249	11891250	13891327	13891326
Ebony	11891256	11891257	13891331	13891330
Gunmetal	18891256	18891257	18891331	18891330
*Evergreen	11891251	11891252	13891329	13891328

NOTE: *DISC (LA) used prior to 10/29/2022

Components for 1/2" Horizontal MRF Mull Kits - Lineal parts for kits are 96" long		
Description	Base Kit Qty	Extra Quantities Needed for Additional Mulling
End Plug, 1/2" Space Mull - PN 11860389	2 per kit	2 extra plugs ordered separately per additional mull
A3134 Mulling Pin, 1/2" Space Mull	2 per kit	
V2789 Mull Weather Strip, 1/2"	1 per kit	
PUR w/1 1/2" Tape	1 per kit	
V2787 Mull Cover (w/Glazing Tape)	1 per kit	
Center Plug - PN 11860388	1 per kit	1 extra plug ordered separately per additional mull (when required)
W12870 Mull Support	1 per kit	
Aluminum Direct Glaze Round Top Mull Support	1 per kit	
W1243 Mull Trim	1 per kit	
Mull Bracket PN - 11040358	1 per kit	
#7-19 x 5/8" Bracket Screw PN - 11800743	36 per kit	40 extra screws needed per additional mull
#8 x 1 3/4" End Plug Screw PN - 11808176	2 per kit	2 extra screws needed per additional mull
V119 Continuous Drip Cap	1 per kit	For assemblies wider than 96", special parts are required
Nailing Fin Connector PN - 10500213	2 per kit	2 extra connectors are required per additional mull

Mull Kits - 1/2" Horizontal MRF Mull Kit

To specify the correct part number you will need to supply the height of the frame, exterior color and interior finish.

1/2" Horizontal MRF Mull Kit Double Hung Direct Glaze Rectangle above Mull				
Exterior Color	Interior Finish and Part Number			
	Bare Wood	White	Designer Black	Clear
Stone White	11891232	11891233	13891333	13891332
Pebble	11891234	11891235	13891335	13891334
Bronze	11891236	11891237	13891337	13891336
Cashmere	11891238	11891239	13891339	13891338
Ebony	11891258	11891259	13891343	13891342
Gunmetal	18891258	18891259	18891343	18891332
*Evergreen	11891240	11891241	13891341	13891340

NOTE: *DISC (LA) used prior to 10/29/2022

Components for 1/2" Horizontal MRF Mull Kits - Lineal parts for kits are 96" long		
Description	Base Kit Qty	Extra Quantities Needed for Additional Mulling
End Plug, 1/2" Space Mull - PN 11860389	2 per kit	2 extra plugs ordered separately per additional mull
A3134 Mulling Pin, 1/2" Space Mull	2 per kit	
V2789 Mull Weather Strip, 1/2"	1 per kit	
PUR w/1 1/2" Tape	1 per kit	
V2787 Mull Cover (w/Glazing Tape)	1 per kit	
Center Plug - PN 11860388	1 per kit	1 extra plug ordered separately per additional mull (when required)
W12870 Mull Support	1 per kit	
W13061 6 9/16" Inswing French Door Mull Support	1 per kit	
W1242 Mull Trim	1 per kit	
#7-19 x 5/8" Bracket Screw PN - 11800743	36 per kit	40 extra screws needed per additional mull
#8 x 1 3/4" End Plug Screw PN - 11808176	2 per kit	2 extra screws needed per additional mull
V119 Continuous Drip Cap	1 per kit	For assemblies wider than 96", special parts are required
Nailing Fin Connector PN - 10500213	2 per kit	2 extra connectors are required per additional mull
#10 x 2 3/4" Screw PN 11800869	2 per kit	For assemblies wider than 2W on the bottom row (doors only), 2 screws are needed for each additional wide unit

Mull Kits - 1/2" Horizontal Door MRF Mull Kit

To specify the correct part number you will need to supply the height of the frame, exterior color and interior finish.

1/2" Horizontal Door MRF Mull Kit								
Exterior Color	Interior Finish and Part Number							
	Bare Wood		White		Designer Black		Clear	
	6" Structural Brackets	10" Structural Brackets	6" Structural Brackets	10" Structural Brackets	6" Structural Brackets	10" Structural Brackets	6" Structural Brackets	10" Structural Brackets
Stone White	21891232	31891232	21891233	31891233	23891333	33891333	23891332	33891332
Pebble	21891234	31891234	21891235	31891235	23891335	33891335	23891334	33891334
Bronze	21891236	31891236	21891237	31891237	23891337	33891337	23891336	33891336
Cashmere	21891238	31891238	21891239	31891239	23891339	33891339	23891338	33891338
Ebony	21891258	31891258	21891259	31891259	23891343	33891343	23891342	33891342
Gunmetal	28891258	38891258	28891259	38891259	28891343	38891343	28891332	38891332

Components for 1/2" Horizontal MRF Mull Kits - Lineal parts for kits are 96" long		
Description	Base Kit Qty	Extra Quantities Needed for Additional Mulling
End Plug, 1/2" Space Mull - PN 11860389	2 per kit	2 extra plugs ordered separately per additional mull
A3134 Mulling Pin, 1/2" Space Mull	2 per kit	
V2789 Mull Weather Strip, 1/2"	1 per kit	
PUR w/1 1/2" Tape	1 per kit	
V2787 Mull Cover (w/Glazing Tape)	1 per kit	
Center Plug - PN 11860388	1 per kit	1 extra plug ordered separately per additional mull (when required)
W12870 Mull Support	1 per kit	
W13061 6 9/16" Inswing French Door Mull Support	1 per kit	
W1242 Mull Trim	1 per kit	
#7-19 x 5/8" Bracket Screw PN - 11800743	72 per kit	40 extra screws needed per additional mull
#8 x 1 3/4" End Plug Screw PN - 11808176	2 per kit	2 extra screws needed per additional mull
V119 Continuous Drip Cap	1 per kit	For assemblies wider than 96", special parts are required
Nailing Fin Connector PN - 10500213	2 per kit	2 extra connectors are required per additional mull
#10 x 2 3/4" Screw PN -11800869	2 per kit	For assemblies wider than 2W on the bottom row (doors only) 2 screws are needed for each additional wide unit
6" Structural Bracket - 11860002	4 per kit	
10" Structural Bracket - 11860003	4 per kit	

IZ3 Mull Kits

To specify the correct part number you will need to supply the width and height of the unit, configuration, interior finish and product type.

NOTE: Refer to the Mull Kit Component list section for details on what is included with each kit.

Kit	ID	Description	Size	Finish and Part Number			
				Bare Wood	White	Designer Black	Clear
Vertical Casement/Awning Mull Kit	Clip Install						
	A	19-48" (838-1219)	CN47	11897260	11897279	39937201	33837201
		49-72" (1245-1829)	CN71	11897261	11897280	39937202	33837202
		96" (2438)	Lineal 96"	11897262	11897281	39937203	33837203
	Masonry Install						
	B	19-48"(838-1219)	CN47 Masonry 6"	11897263	11897282	39937204	33837204
		19-48" (838-1219)	CN47 Masonry 10"	11897264	11897283	39937207	33837207
		49-72" (1245-1829)	CN71 Masonry 6"	11897265	11897284	39937205	33837205
		49-72" (1245-1829)	CN71 Masonry 10"	11897266	11897285	39937208	33837208
		96" (2438)	Lineal 96" Masonry 6"	11897267	11897286	39937206	33837206
		96" (2438)	Lineal 96" Masonry 10"	11897268	11897287	39937209	33837209

Component ID List Casement/Awning		
Component	A	B
Mullion Pin – A330	1	1
Foam Tape – 1/2x3/32	1	1
Mull Reinforcement Board–W10978	1	1
Sill Standing Block–W13003	1	2
W1243 Mull Trim	1	1
Installation Screws	10	10
Mull Clip Screws	12	14
Elevate Casement Mull Clip	1	
Nail Fin Connector	1	1
Mull Structural Bracket		2
Installation Instructions	1	1

IZ3 Mull Kits

To specify the correct part number you will need to supply the width and height of the unit, configuration, interior finish and product type.

NOTE: Refer to the Mull Kit Component list section for details on what is included with each kit.

Kit	ID	Description	Size	Finish and Part Number			
				Bare Wood	White	Designer Black	Clear
Horizontal Casement/Awning Mull Kit	Clip Install						
	C		CN47 Clip	11897269	11897288	39937221	33837221
			CN71 Clip	11897270	11897289	39937222	33837222
			Lineal 96" Clip	11897271	11897290	39937223	33837223
	Masonry Install						
	D	19-48"(838-1219)	CN47 Masonry 6"	11897272	11897291	39937224	33837224
		19-48" (838-1219)	CN47 Masonry 10"	11897273	11897292	39937227	33837227
		49-72" (1245-1829)	CN71 Masonry 6"	11897274	11897293	39937225	33837225
		49-72" (1245-1829)	CN71 Masonry 10"	11897275	11897294	39937228	33837228
		96" (2438)	Lineal 96" Masonry 6"	11897277	11897295	39937226	33837226
		96" (2438)	Lineal 96" Masonry 10"	11897278	11897296	39937229	33837229

Component ID List Casement/Awning		
Component	C	D
Mullion Pin – A330	1	1
Foam Tape – 1/2x3/32	1	1
Mull Reinforcement Board–W10978	1	1
W1243 Mull Trim	1	1
Header Screws	5	5
Installation Screws	5	5
Mull Clip Screws	24	26
Elevate Casement Mull Clip	2	
Nail Fin Connector	1	1
Mull Structural Bracket		2
Installation Instructions	1	1

IZ3 Mull Kits

To specify the correct part number you will need to supply the width and height of the unit, configuration, interior finish and product type.

NOTE: Refer to the Mull Kit Component list section for details on what is included with each kit.

Kit	ID	Description	Size	Finish and Part Number			
				Bare Wood	White	Designer Black	Clear
Vertical Double Hung Mull Kit	Clip Install						
	A	36"-48 1/4" (914-1226)	CN48	11897317	11897362	39937362	33837362
		48"-60 1/4" (1219-1530)	CN60	11897318	11897363	39937363	33837363
		60"-76 1/4"(1524-1937)	CN76	11897319	11897364	39937364	33837364
		96" (2438)	Lineal 96"	11897320	11897365	39937365	33837365
		120" (3048)	Lineal 120"	11897321	11897366	39937366	33837366
	Masonry Bracket Install						
	B	36"-48 1/4" (914-1226)	CN48-6"	11897322	11897367	39937367	33837367
		36"-48 1/4" (914-1226)	CN48-10"	11897323	11897368	39937368	33837368
		48"-60 1/4"(1219-1530)	CN60-6"	11897324	11897369	39937369	33837369
		48"-60 1/4"(1219-1530)	CN60-10"	11897325	11897370	39937370	33837370
		60"-76 1/4" (1524-1937)	CN76-6"	11897326	11897371	39937371	33837371
		60"-76 1/4" (1524-1937)	CN76-10"	11897327	11897372	39937372	33837372
		96" (2438)	Lineal -6"	11897328	11897373	39937373	33837373
		96" (2438)	Lineal -10"	11897329	11897374	39937374	33837374
		120" (3048)	Lineal -6"	11897330	11897375	39937375	33837375
		120" (3048)	Lineal -10"	11897331	11897377	39937378	33837378

Component ID List - Double Hung		
Component	A	B
Mullion Pin – A330	1	1
Foam Tape – 3/8"x1/16"	**	**
Foam Tape – 5/8"x3/16"	**	**
Aluminum Mull Stiffener	1	1
Mull Sill Block	1	1
W1241 Mull Trim	1	1
Mull Tie	1	1
Sill Block Screw	1	1
Mull Clip Screws	**	**
Nail Fin Connector	1	1
Double Hung Mull Clip	1	2
Installation Instructions	1	1

**Quantity dependent on size ordered

IZ3 Mull Kits

To specify the correct part number you will need to supply the width and height of the unit, configuration, interior finish and product type.

NOTE: Refer to the Mull Kit Component list section for details on what is included with each kit.

Kit	ID	Description	Size	Finish and Part Number			
				Bare Wood	White	Designer Black	Clear
Horizontal Double Hung Mull Kit	Clip Install						
	C	22"–30 1/4" (559–768)	CN30	11897332	11897378	39937478	33837478
		30"–36 1/4" (762–921)	CN36	11897333	11897379	39937479	33837479
		36"–42 1/4" (914–1073)	CN42	11897334	11897380	39937480	33837480
		96" (2438)	Lineal 96"	11897335	11897381	39937481	33837481
		120" (3048)	Lineal 120"	11897336	11897382	39937482	33837482
	Masonry Bracket Install						
	D	22"–30 1/4" (559–768)	CN30–6"	11897337	11897383	39937483	33837483
		22"–30 1/4" (559–768)	CN30–10"	11897338	11897385	39937484	33837484
		30"–36 1/4" (762–921))	CN36–6"	11897338	11897386	39937485	33837485
		30"–36 1/4" (762–921)	CN36–10"	11897340	11897387	39937486	33837486
		36"–42 1/4" (914–1073)	CN42–6"	11897341	11897388	39937487	33837487
		36"–42 1/4" (914–1073))	CN42–10"	11897342	11897389	39937488	33837488
		96" (2438)	Lineal –6"	11897343	11897390	39937489	33837489
		96" (2438)	Lineal –10"	11897344	11897391	39937490	33837490
		120" (3048)	Lineal –6"	11897345	11897392	39937491	33837491
		120" (3048)	Lineal –10"	11897346	11897393	39937492	33837492

Component ID List Double Hung		
Component	C	D
Mullion Pin – A330	1	1
Foam Tape – 5/8"x3/16"	**	**
W9159 Mull Trim	1	1
W8952 Mull Support	1	1
Mull Clip Screws	**	**
Elevate Double Hung Mull Clip	2	1
Nail Fin Connector	1	2
Installation Instructions	1	1

**Quantity dependent on size ordered

IZ3 Mull Kits

To specify the correct part number you will need to supply the width and height of the unit, configuration, interior finish and product type.

NOTE: Refer to the Mull Kit Component list section for details on what is included with each kit.

Kit	ID	Description	Size	Finish and Part Number			
				Bare Wood	White	Designer Black	Clear
Horizontal Double Hung/ Direct Glaze Rectangle Mull Kit	Clip Install						
	E	22"–30 1/4" (559–768)	CN30	11897347	11897393	39937293	33837293
		30"–36 1/4" (762–921)	CN36	11897348	11897394	39937294	33837294
		36"–42 1/4" (914–1073)	CN42	11897349	11897395	39937295	33837295
		96" (2438)	Lineal 96"	11897350	11897396	39937296	33837296
		120" (3048)	Lineal 120"	11897351	11897397	39937297	33837297
	Masonry Bracket Install						
	F	22"–30 1/4" (559–768)	CN30–6"	11897352	11897398	39937298	33837298
		22"–30 1/4" (559–768)	CN30–10"	11897353	11897399	39937299	33837299
		30"–36 1/4" (762–921))	CN36–6"	11897354	11897400	39937300	33837300
		30"–36 1/4" (762–921)	CN36–10"	11897355	11897401	39937301	33837301
		36"–42 1/4" (914–1073)	CN42–6"	11897356	11897402	39937302	33837302
		36"–42 1/4" (914–1073))	CN42–10"	11897357	11897403	39937303	33837303
		96" (2438)	Lineal –6"	11897358	11897404	39937304	33837304
		96" (2438)	Lineal –10"	11897359	11897405	39937305	33837305
		120" (3048)	Lineal –6"	11897360	11897406	39937406	33837406
	120" (3048)	Lineal –10"	11897361	11897407	39937407	33837407	

Component ID List Double Hung		
Component	E	F
Mullion Pin - A330	1	1
Foam Tape - 5/8" x 3/16"	**	**
W1241 Mull Trim	1	1
Mull Clip Screws	**	**
Outswing French Door Mull Clip	2	
Nail Fin Connector	1	1
Mull Structural Bracket		2
Installation Instructions	1	1

**Quantity dependent on size ordered

IZ3 Mull Kits

To specify the correct part number you will need to supply the width and height of the unit, configuration, interior finish and product type.

NOTE: Refer to the Mull Kit Component list section for details on what is included with each kit.

Kit	ID	Description	Finish and Part Number			
			Bare Wood	White	Designer Black	Clear
Clip Install						
Vertical Mull Kit	A	Outswing French Door to Outswing French Door	11897297	11897306	39937241	33837424
Horizontal Mull Kit	B	Single Direct Glaze Rectangle over Outswing French Door	11897298	11897307	39937244	33837244
	C	Single Direct Glaze Rectangle over 2W Outswing French Door	11897299	11897308	39937247	33837247
Masonry Install						
Vertical Mull Kit	D	Outswing French Door to Outswing French Door - 6"	11897300	11897309	39937242	33837242
		Outswing French Door to Outswing French Door - 10"	11897301	11897310	39937243	33837243

Component ID List Doors				
Component	A	B	C	D
Mullion Pin – A330	1	1	1	1
3/8"x1/8" Mull Tape – 1 sided	1			1
1/2"x3/32" Mull Tape – 1 sided		1	1	
Nail Fin Connector	1	1	1	1
Foam L Gasket	1			1
Mull Structural Bracket 6" –10"	1			1
Mulling Sill Bracket	2			1
W1241 Mull Trim	1	1	1	1
Elevate Outswing French Door Mull Clip	1	2	2	
Mull Clip Screws	**	**	**	**
#8 x 1 3/4" Type AB Full Thread			14	
Installation Instructions	1	1	1	1

**Quantity dependent on size ordered

IZ3 Mull Kits

To specify the correct part number you will need to supply the width and height of the unit, configuration, interior finish and product type.

NOTE: Refer to the Mull Kit Component list section for details on what is included with each kit.

Kit	ID	Description	Finish and Part Number			
			Bare Wood	White	Designer Black	Clear
Masonry Install						
Horizontal Mull Kit	E	Single Direct Glaze Rectangle over Outswing French Door - 6"	11897302	11897311	39937245	33837245
	E	Single Direct Glaze Rectangle over Outswing French Door - 10"	11897303	11897312	39937246	33837246
	F	Single Direct Glaze Rectangle over 2W Outswing French Door - 6"	11897304	11897313	39937248	33837248
	F	Single Direct Glaze Rectangle over 2W Outswing French Door - 10"	11897314	11897314	39937249	33837249
Clip/Masonry Install						
Horizontal Mull Kit	G	Single Direct Glaze Rectangle over Sliding French Door	11897315	11897316	39937261	33837261

Component ID List Doors			
Component	E	F	G
Mullion Pin – A330	1	1	1
1/2"x3/32" Mull Tape – 1 sided	1	1	1
Nail Fin Connector	1	1	1
Mull Structural Bracket 6" –10"	2	2	
W1241 Mull Trim	1	1	1
Outswing French Door Mull Clip		2	
Mull Clip Screws	**	**	
#8 x 1 3/4" Type AB Full Thread		14	
Installation Instructions	1	1	1

**Quantity dependent on size ordered

Mullion Pin

A330

Description	CN	Length	PN
Casement/Awning	CN47	46 5/8" (1184)	15344348
	CN71	70 5/8" (1794)	15344372
Double Hung/Glider	CN48	46 3/4" (1187)	15344148
	CN72	70 3/4" (1797)	15344172
Double Hung Insert	CN84	83 1/4" (2115)	15344184
Sliding Patio Door, Sliding French Door, Inswing French Door, Outswing French Door	Vertical	71 1/2" (1816)	15344273
	Horizontal	81 1/2" (2070)	15344468
Lineal		150" (3810)	11103250

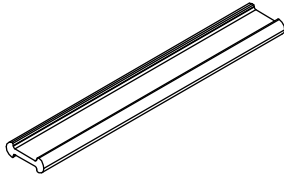

Mullion Insulation

Used in casement mull kits

Length	PN
96" (2438)	10501115

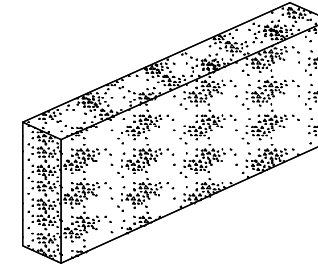

IZ3 2W Mull Jamb Stiffener Kit

Double Hung, Double Hung Picture, Double Hung Direct Glaze Rectangle

Includes:

1 - IZ3 Aluminum Mull Stiffener

Foam tape, 3/8" x 1/16", according to size ordered (CN48 - 26 LF, CN60 - 28 LF, CN76 - 32 LF, Lineal 96" - 40 LF, Lineal 120" - 48 LF)

Size	Length	PN
CN48 to CN16	43 3/4" (1111)	11897421
CN 60 to 48	55 3/4" (1416)	11897422
CN 76 to 60	71 3/4" (1822)	11897423
Lineal	96" (2438)	11897424
Lineal	120" (3048)	11897425

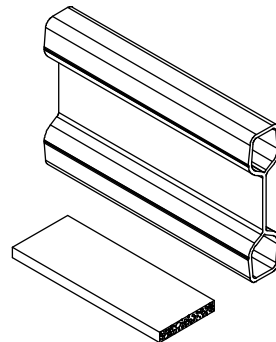

3 1/2" Galvanized Mull Tin

26 gauge

Includes:

- 2 - Mull tin
- 6 - #8 x 3/8" Phillips pan head screws

Length	PN
16" (406)	02070302

2 1/2" Galvanized Mull Tin

26 gauge

NOTE: For Aluminum Direct Glaze Round Top units only, 2 per unit

Length	PN
16" (406)	02070460

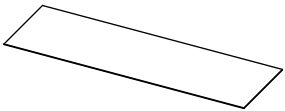

Mull Tie Bracket

PN
11870000

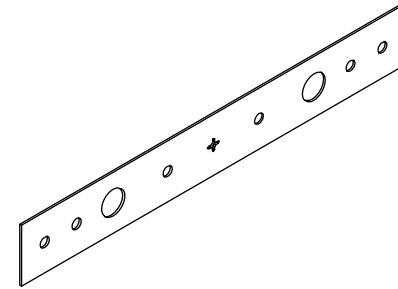

Steel Mullion Bracket

NOTE: For Double Hung units, two needed for horizontal mull.

PN
11040358

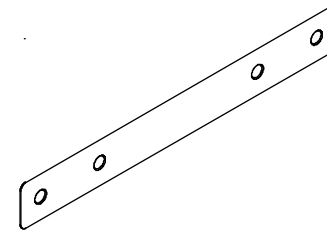

Sill Mull Bracket

Inswing French Door to Inswing French Door
Outswing French Door to Outswing French Door

NOTE: Both mull options use the same part number

PN
11862522

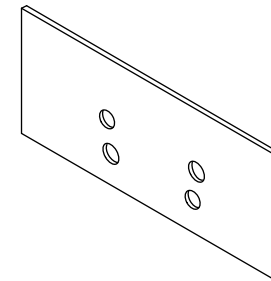

IZ3 Elevate Casement Mull Clip Kit

NOTE: For structural mullion kits.

Includes:

- 1 - Casement Installation Mull Clip
- 10 - #7 x 5/8" type AB-17, full thread screws

PN
11897415

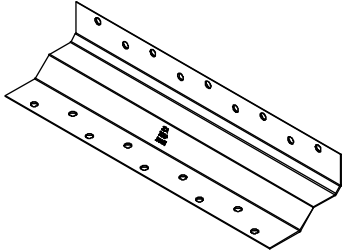

IZ3 Elevate Outswing French Door Mull Clip Kit

Includes:

- 1 - Outswing French Door Installation Mull Clip
- 15 - #7 x 5/8" type AB-17, full thread screws

PN
11897418

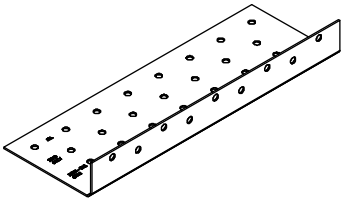

IZ3 Elevate Double Hung Mull Clip Kit

Includes:

- 1 - Double Hung Installation Mull Clip
- 14- #7 x 5/8" type AB-17, full thread screws

PN
11897427

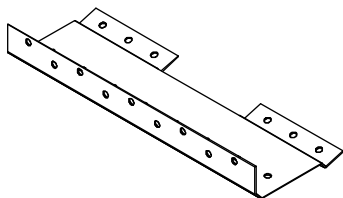

IZ3 Mull Structural Bracket Kit, 6"

NOTE: For Casement, Casement Picture, Awning, Double Hung, Double Hung Picture, Direct Glaze Rectangle, Outswing French Door

Includes:

- 1 - 6" Mull Structural Bracket
- 12 - #7 x 5/8" type AB-17, full thread screws

PN
11897416

IZ3 Mull Structural Bracket Kit, 10"

NOTE: For Casement, Casement Picture, Awning, Double Hung, Double Hung Picture, Direct Glaze Rectangle, Outswing French Door

Includes:

- 1 - 10" Mull Structural Bracket
- 12 - #7 x 5/8" type AB-17, full thread screws

PN
11897417

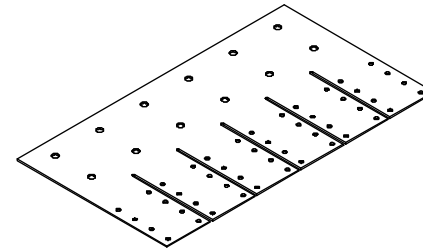

IZ3 Fastener Outswing French Door

#8 x 1 3/4" Type AB, full thread screw

PN
11881123

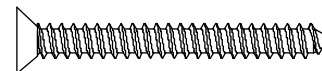

Vertical Foam Mull Filler

Double Hung Insert

PN
10500025

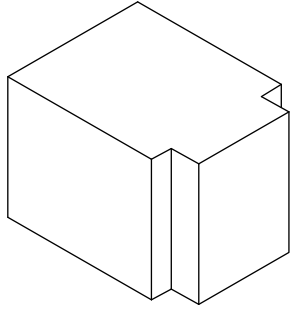

Nailing Fin Connector

Color	PN
White	10500213

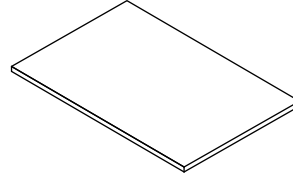

Connecting Barb

V803

Length	PN
Specify LF	15812999
96"	15812008
120"	158120

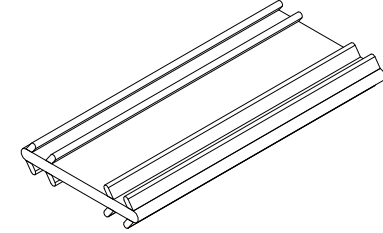

Mull Tape - 1 Sided Adhesive

3/32" x 1/2"

Color	Length	PN
Black	96" (2438)	11869508
	150' Roll (45m)	11406224



Mull Tape - 2 Sided Adhesive

1/16" x 3/8"

Color	Length	PN
Black	96" (2438)	11406227
	150 LF (45.7m)	11406226

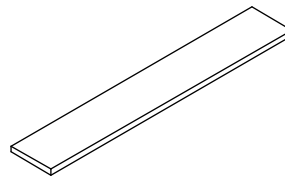

IZ3 Foam L Gasket

Outswing French Door

Size	PN
1 3/4" x 1 3/4"	10500388

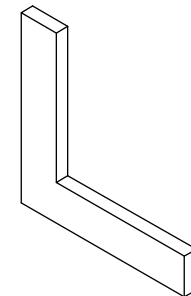

Mull Cover

V2787

Includes:

3/8" glazing tape

Length	Color and Part Number							
	Stone White	Pebble	Bronze	Cashmere	Ebony	Gunmetal	*Evergreen	
96" (2348)	17011801	17011802	17011803	17011804	17011807	17811801	17011805	

NOTE: *DISC (LA) used prior to 10/29/2022

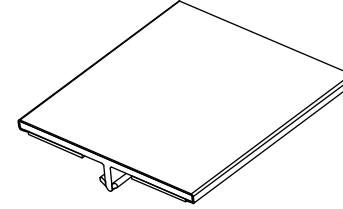

Inswing French Door Mull Cover

V1213

Length	Color and Part Number							
	Stone White	Pebble	Bronze	Cashmere	Ebony	Gunmetal	*Evergreen	
120" (3048)	153099	153399	153699	153489	1539199	1539200	153789	

NOTE: *DISC (LA) used prior to 10/29/2022

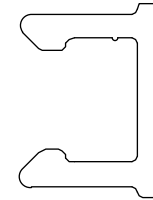

Mull Cover

V2316

Double Hung Insert

CN	Length	Color and Part Number						
		Stone White	Pebble	Bronze	Cashmere	Ebony	Gunmetal	*Evergreen
48	47 27/32" (1215)	17001248	17001348	17001848	17002148	17003048	17881248	17001948
60	59 27/32" (1520)	17001260	17001360	17001860	17002160	17003060	17881260	17001960
84	83 27/32" (2130)	17001184	17001384	17001884	17002184	17003084	17881184	17001984

NOTE: *DISC (LA) used prior to 10/29/2022

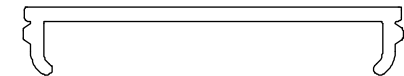

Eurogroove Block

V1407

NOTE: For Inswing and Outswing French Door Vertical Mull Kit

Color	PN
Beige	11860111

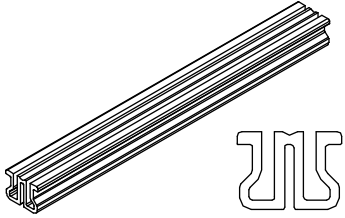

End Plug, 1/2"

Direct Glaze, Inswing French Door, Outswing French Door, Aluminum Direct Glaze Round Top, Double Hung, Double Hung Picture, Double Hung Direct Glaze Rectangle, Glider

Color	PN
Black	11860389

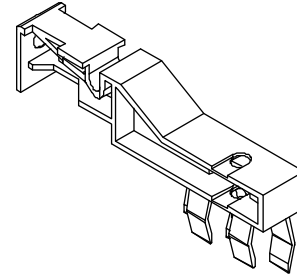

Center Plug

Color	PN
Natural	11860388

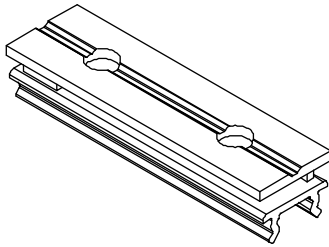

Interior Mullion Trim

W1241

Product Usage:

Direct Glaze Round Top, Aluminum Direct Glaze Round Top, Double Hung (Operator, Picture, Rectangle), Glider and Glider Triple Sash, Sliding Patio Door, Inswing French Door, Outswing French Door.

Size	Finish and Part Number			
	Bare Wood	White	Designer Black	Clear
Direct Glaze Round Top 36-2W	31501784	39201784	39931784	33831784
Lineal 96" (2438)	31501396	39201396	39931396	31601396
Lineal 120" (3048)	32249099	39249099	39939099	33839099

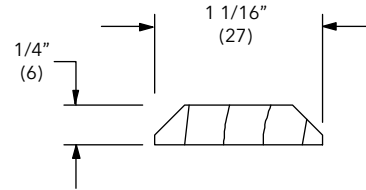

Interior Mullion Trim

W1242

Product Usage:

Direct Glaze Round Top, Direct Glaze Round Top Casement, Direct Glaze Round Top Double Hung, Direct Glaze Door Rectangle.

Size	Finish and Part Number			
	Bare Wood	White	Designer Black	Clear
Quarter Circle 29-1W	31501771	39201771	39931771	33831771
Direct Glaze Round Top 29-1W	31501771	39201771	39931771	33831771
Direct Glaze Round Top 21-2W	31501772	39201772	39931772	33831772
Direct Glaze Round Top 25-2W	31501773	39201773	39931773	33831773
Direct Glaze Round Top 29-2W	31501774	39201774	39931774	33831774
Direct Glaze Round Top 25-3W	31501775	39201775	39931775	33831775
Lineal 96" (2438)	31501296	39201296	39939196	31601296
Lineal 120" (3048)	32249199	39249199	39939199	33839199

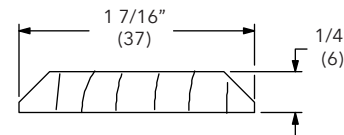

Interior Mullion Trim

W1243

NOTE: For casement mulls

Size	Finish and Part Number			
	Bare Wood	White	Designer Black	Clear
Lineal 96" (2438)	33730398	39230398	39930498	33830498
Lineal 120" (3048)	33730399	39230399	39930499	33830499

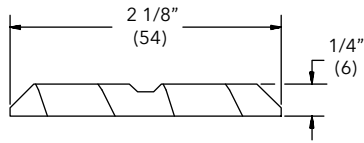

Vertical Mullion Trim

W11965

NOTE: For Double Hung Insert mulls

Size	Finish and Part Number			
	Bare Wood	White	Designer Black	Clear
47 5/8" (1210)	31509048	39209048	39229548	31600648
59 5/8" (1514)	31509060	39209060	39229560	31619060
83 5/8" (2124)	31509084	39209084	39229584	31619084

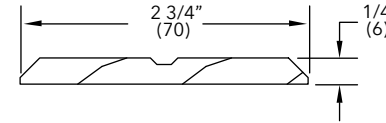

Horizontal Mullion Trim

W9159

NOTE: For Double Hung mulls

Size	Finish and Part Number			
	Bare Wood	White	Designer Black	Clear
Lineal 96" (2438)	33730496	39230496	39239496	33830296
Lineal 120" (3048)	33730498	39230498	39239498	33830298

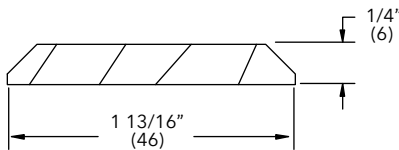

Structural Mull Tie

W9295

NOTE: Use for Double Hung and Glider manufactured after January 2006

Size	Finish and Part Number			
	Bare Wood	White	Designer Black	Clear
Lineal 84" (2134)	31510984	39210984	39219984	31600984

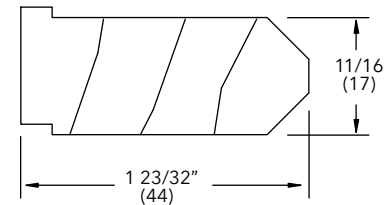

Casement Mullion Filler Block

W6172

Length	PN
16" (406)	33732900

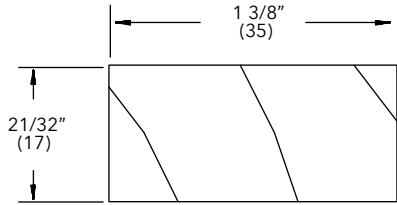

IZ3 2W Sill Wood Block Kit

Double Hung, Double Hung Picture, Double Hung Rectangle

Length	PN
96" (2438)	11897426

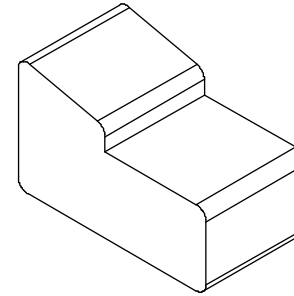

Mull Reinforcement Block

W7008

Casement and Awning

NOTE: Used for standard mulling

Description	Length	PN
Lineal	96" (2438)	33733196

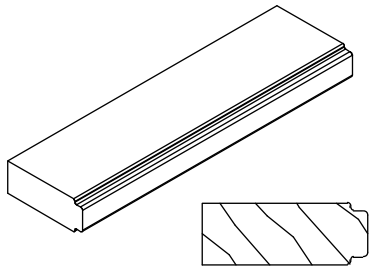

Mull Support

W8952

NOTE: Tie used on vertical kits. Used as a filler on horizontal kits.

Description	Length	PN
Mull Tie	12" (305)	33732917
CN42	41 5/16" (1049)	31509342
Lineal	96" (2438)	31509396

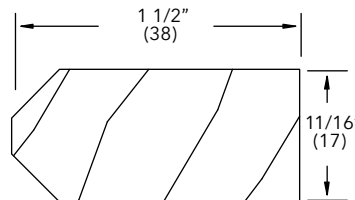

Mull Reinforcement Board

W10978 LVL material

Casement and Awning

NOTE: Used for structural and IZ3 mulling

Description	Length	PN
CN32	32" (813)	33733201
CN48	48" (1219)	33733202
CN72	72" (1829)	33733203
Lineal	97" (2464)	33733204

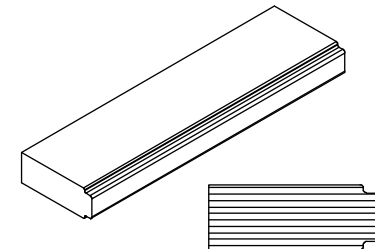

Interior Sill Mullion Bracket

NOTE: For Elevate Sliding Door units (vertical mull).

PN
11860145

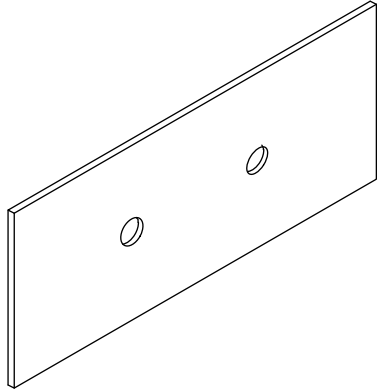

Exterior Sill Mullion Bracket

NOTE: For Elevate Sliding Door units (vertical mull).

PN
11040390

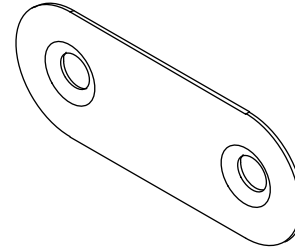

Interior Mullion Trim

W1241

NOTE: For Pre 3/1/04 Doors horizontal mulls: Patio Door, Sliding Door, Sliding Door to Aluminum Direct Glaze Round Top (6 9/16"), Double Hung to Direct Glaze Round Top. Vertical mulls: Sliding Door, Double Hung

Description	Bare Wood PN	White PN
Direct Glaze Round Top Door 7336	31501785	39201785

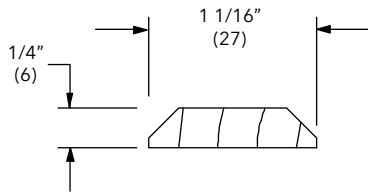

Elevate Double Hung Mullion Tie/Filler

W7431

Length	Bare Wood PN	Prefinish Wood PN
12" (305)	31500006	NA

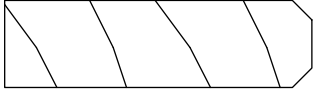

Structural Mull Tie

W2169

NOTE: Must be ordered in addition to vertical mull kit when mulling a Polygon to an Elevate Casement. Adhesive tape attached.

Usage dates:

Double Hung and Glider manufactured before January 2006

Description	Length	Bare Wood PN	Prefinish Wood PN
Pine	84" (2134)	31500084	39200084

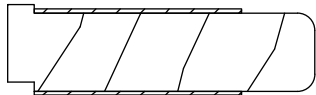

Structural Mull Tie

W8570

NOTE: Used on 2 wide x 2 high Double Hung mullions.

Description	Length	Bare Wood PN	Prefinish Wood PN
Douglas Fir	84" (2134)	31500085	NA



Double Hung/Glider Vertical Mullion Kits

Pre 2006

Length	Bare Wood PN	Prefinish Wood PN
CN48	11898620	39258620
CN72	11898624	39258624
120" (3048)	11898626	39258626

No Image Available

Double Hung Horizontal Mullion Kits

Pre 2006

Length	Bare Wood PN	Prefinish Wood PN
CN42	11898634	39258634
120" (3048)	11898636	39258636

No Image Available

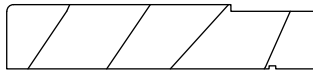

Horizontal Mull Filler
6 9/16", W8430



Wood Mullion Tie, W7004

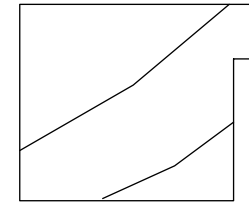

Jamb Extension, 5 5/16",
W7445

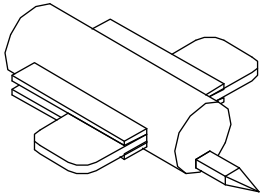

Spring Loaded Fastener

Used for product prior to 1/19/2019

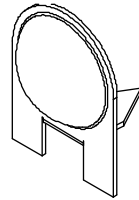

Grille Tack, Sash/Panel

Used for product 1/19/2010 to 12/16/2019

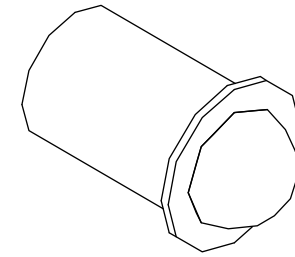

Bullet Catch (Grille Fastener)

Used on Round Top products prior 12/16/2019

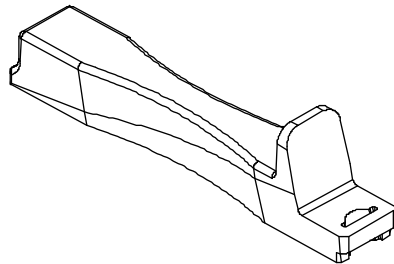

Installation Tool for Grille Tack

Used for product 1/18/2010 to 12/16/2019

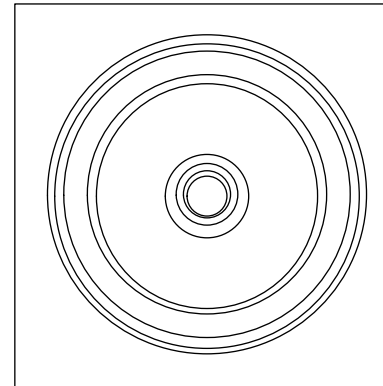

3" and 4" Plinth Blocks

No longer available

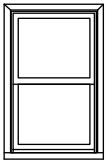

**BMC Flush
with Sill
Nosing**

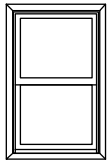

**BMC Mitered
Casing Four
Sides**

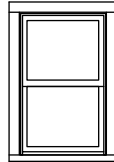

**Flat Casing
Flush with Sill
Nosing**

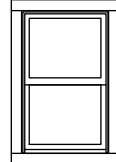

**Flat Casing
Flush Casing
Four Sides**

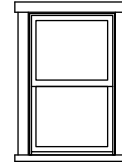

**Flat Casing
Ranch Style
with Sill Nosing**

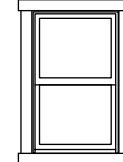

**Flat Casing Ranch Style
Casing Four Sides**

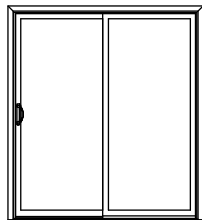

BMC Door

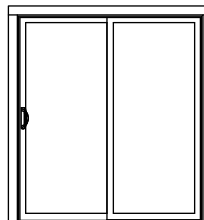

Flat Casing Door

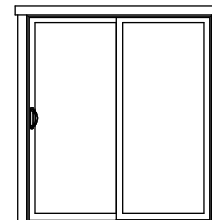

Flat Casing Ranch Style Door

When ordering exterior casing cut to length kits, specify:

1. Product type
2. Call number, rough opening or frame size
3. Exterior color
4. Casing configuration

NOTE: See Architectural Detail manual Accessories or Customer Support for individual component ordering information. End Caps are included with Exterior Casing orders.

Parts in Kit	Type of Kit								
	BMC	BMC with Sill Nosing	Flat Casing	Flat Casing with Sill Nosing	Flat Casing Ranch Style	Flat Casing Ranch Style with Sill Nosing	BMC Door	Flat Casing Door	Flat Casing Ranch Style Door
	Quantity in Kit								
Corner Key	4	4	4	4	4	4	2	2	2
Reticulated Foam	2	2	2	2	2	2			
Sill Nosing Left Hand End Cap		1		1		1			
Sill Nosing Right Hand End Cap		1		1		1			
Flat Casing Left Hand End Cap			2	1	2	1		2	2
Flat Casing Right Hand End Cap			2	1	2	1		2	2
BMC Foam Plug							2		
Instruction	1	1	1	1	1	1	1	1	1
Screw Package (12)							1	1	1
Screw Package (20)	1	1	1	1	1	1			

Connecting Barb V2177 - Quantity needed per unit size						
Height - Inches (mm)	Width - Inches (mm)					
	0-35 (0-889)	+35 – 59 (+889 – 1499)	+59 – 83 (+1499 – 2108)	+83 – 107 (+2108 – 2718)	+107 – 131 (+2718 – 3327)	+131 – 155 (+3327 – 3937)
0 – 35 (0 – 889)	8	10	12	14	16	18
+35 – 5 (+889 – 1499)	10	12	14	16	18	20
+59 – 83 (+1499 – 2108)	12	14	16	18	20	22
+83 – 107 (+2108 – 2718)	14	16	18	20	22	24
+107 – 131 (+2718 – 3327)	16	18	20	22	24	26
+131 – 155 (+3327 – 3937)	18	20	22	24	26	28

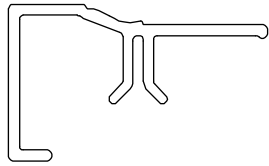

2" Brick Mould Casing
F9105



3 1/2" Flat Casing
F9108

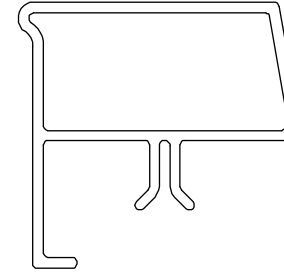

2" Sill Nosing
F9107

Description	Length	Color and Part Number						
		Stone White	Pebble	Bronze	Cashmere	Ebony	Gunmetal	*Evergreen
2" Brick Mould Casing, F9105	53" (1346)	7021053	7001053	7051053	7081053	7071053	8021053	7061053
	77" (1956)	7021077	7001077	7051077	7081077	7071077	8021077	7061077
	106" (2692)	7021106	7001106	7051106	7081106	7071106	8021106	7061106
	144" (3658)	7021144	7001144	7051144	7081144	7071144	8021144	7061144
	200" (5080)	7021200	7001200	7051200	7081200	7071200	8021200	7061200
3 1/2" Flat Casing, F9108	53" (1346)	7024153	7004053	7054053	7084053	7074053	8024153	7064053
	77" (1956)	7024177	7004077	7054077	7084077	7074077	8024177	7064077
	106" (2692)	7024106	7004106	7054106	7084106	7074106	8024106	7064106
	144" (3658)	7024144	7004144	7054144	7084144	7074144	8025144	7064144
	200" (5080)	7014200	7004200	7054200	7084200	7074200	8014200	7064200
2" Sill Nosing, F9107	53" (1346)	7023053	7003053	7053053	7083053	7073053	8023053	7063053
	77" (1956)	7023077	700377	7053077	7083077	7073077	8023077	7063077
	106" (2692)	7023106	7003106	7053106	7083106	7073106	8023106	7063106
	144" (3658)	7023144	7003144	7053144	7083144	7073144	8023144	7063144

NOTE: *DISC (LA) used prior to 10/29/2022

Flat Casing End Cap

Color	LH PN	RH PN
Stone White	10501681	10501682
Pebble	10501683	10501684
Bronze	10501685	10501686
Cashmere	10501689	10501690
Ebony	10501691	10501692
Gunmetal	10581681	10581682
*Evergreen	10501687	10501688

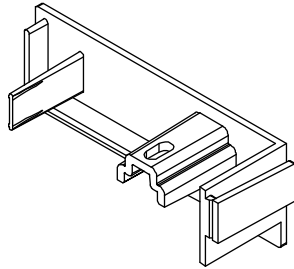

NOTE: *DISC (LA) used prior to 10/29/2022

Sill Nosing End Cap

Color	LH PN	RH PN
Stone White	10501601	10501602
Pebble	10501603	10501604
Bronze	10501605	10501606
Cashmere	10501609	10501610
Ebony	10501611	10501612
Gunmetal	10581601	10581602
*Evergreen	10501607	10501608

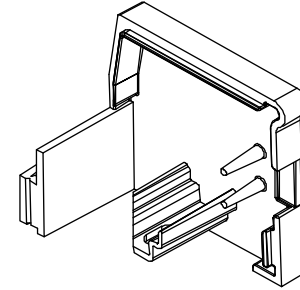

NOTE: *DISC (LA) used prior to 10/29/2022

Corner Key

Color	PN
Natural	10501600

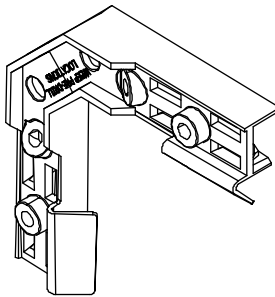

Plug, BMC

Color	PN
Natural	10500163

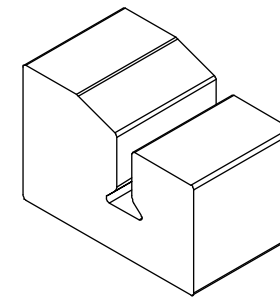

Connection Barb

V2177

Length	PN
6" (152)	16210006

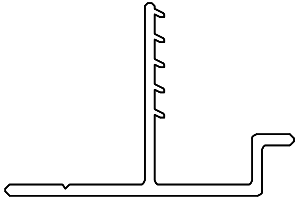

Reticulated Foam

5/8" x 5/8" (16 x 16)

Length	Color	PN
1 1/2"	Charcoal	10500366

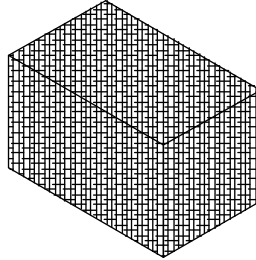

Assembly Screw

#7 x 3/4" Phillips pan head, full thread screws

Color	Pkg of 12 PN	Pkg of 20 PN
Stainless Steel	11806165	11806166

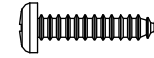

Flat Casing End Cap

Usage dates:

Used prior to 8/11/2014

Color	LH PN	RH PN
Stone White	10501661	10501662
Pebble	10501663	10501664
Bronze	10501665	10501666
Evergreen	10501667	10501668
Cashmere	10501669	10501670
Ebony	10501671	10501672

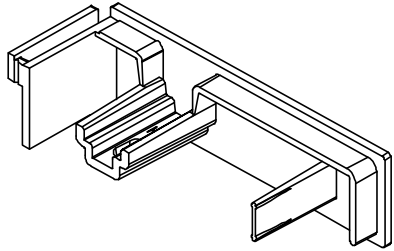



3 1/2" Flat Casing - F9106
No Longer Available

Touch Up Paint - Brush

.6 oz. bottle with applicator

Color	PN
White (Interior)	05120115
Stone White	01530322
Pebble	01530323
Bronze	01530326
Cashmere	01530336
Ebony	01530330
Designer Black	01530540
Gunmetal	01530349
*Evergreen	01530324

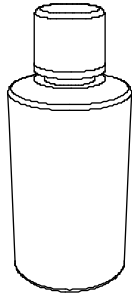

NOTE: *DISC (LA) used prior to 10/29/2022

Touch Up Paint - Aerosol

Size	Color	PN
12 oz	White (Interior)	05120117
12 oz	Bronze	01530335
12 oz	Beige	05120095
4.5 oz	Cashmere	01530345
12 oz	Pebble	02082750
12 oz	Stone White	11402000
12 oz	Ebony	01520173
12 oz	Designer Black	05120118
12 oz	Gunmetal	4015280
4.5 oz	*Evergreen	01530344

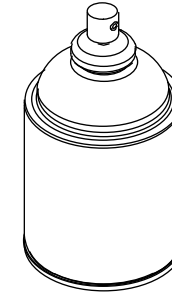

NOTE: *DISC (LA) used prior to 10/29/2022

Epoxy Putty

4 oz. tube

NOTE: For major repairs to Ultrex

PN
11410031

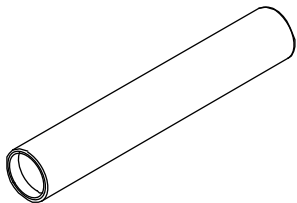

Nail Hole and Crack Repair

PN
02590910

No Image Available

Touch Up Crayon

Color	PN
Designer Black	11401985
Beige	11401886

No Image Available

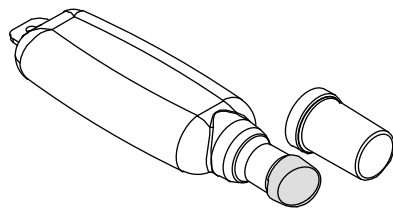

Nail Hole and Crack Repair

7 oz. tube with sponge applicator

No Longer Available