

MODERN MULTI-SLIDE DOOR

Table of Contents

	Page
History	2
Part Identification – Head Jamb and Sill Details (Pocket and Stacked)	3
Part Identification – Jamb Details (Stacked)	4
Part Identification – Jamb Details (Pocket)	5
Replacement of Complete Panels and/or Sills	6
Installation Parts	7
Replacement Parts	8
Aluminum Parts	14
Fiberglass Parts	17
Vinyl Parts	18
Weather Strip	20
Screen Parts	21
Automatic Control Parts	24
Lock Status Sensor Parts	27
Repair items	28

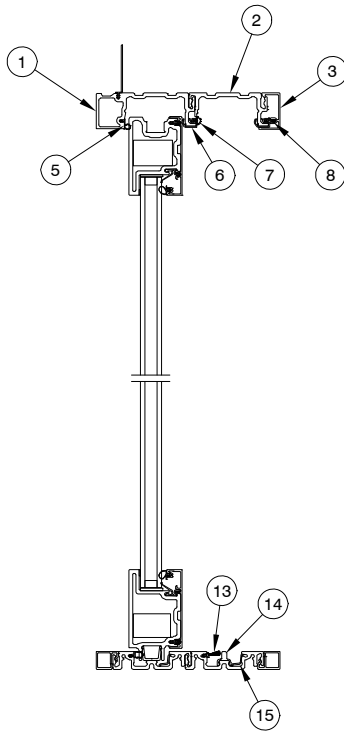
ATTENTION:

- Specification and technical data are subject to change without notice.

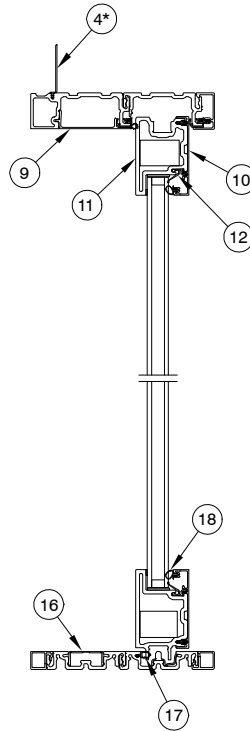
History

PRODUCED	UNIT TYPE	FEATURES OR CHANGES	STATUS
2018	Multi-Slide Door	2018-10-29 - Introduced the Modern Multi-Slide Door.	Present

**Pocket and Stacked
Head Jamb and Sill Details**



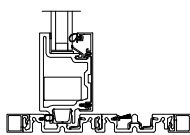
**Stationary/Pocket Panel
Head Jamb and Sill
with 15/16" Glass**



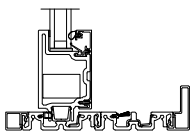
**Primary/Inactive Panel
Head Jamb and Sill
with 15/16" Glass**

1. Exterior Frame
2. Frame
3. Frame Liner, A3248
4. Nail Fin, V2920*
5. Frame Weather Strip, V2475
6. Frame Clip, V2884
7. Head Jamb Weather Strip, V2977
8. Connecting Barb, V803
9. Jamb/Head Jamb Exterior Cover, F2065
10. Clad, Locking/Stationary Stile, 15/16" Glass, A3362
11. Stile, Locking/Stationary
12. Glazing Clip, V2874
13. Pile Weather Strip, V2493
14. Roller Track, V2426
15. Sill Slot Cover, A3240
16. Sill Track Cover, A2736
17. Sill Bulb Weather Strip, V2564
18. Interior Glazing Seal, V2949
19. High Performance Sill Liner Nosing, A2863
20. Clad, Locking/Stationary Stile, 1 1/4" Glass, A3349

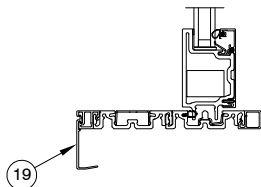
* Not included on Pocket Door



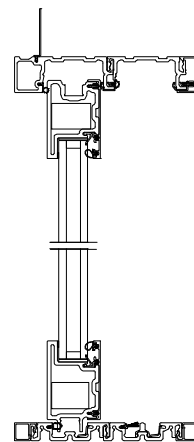
**Flush
Sill Option**



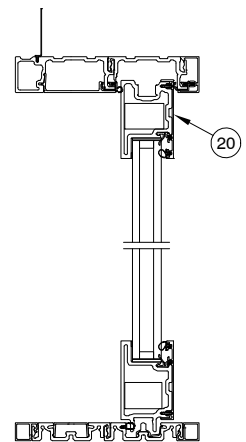
**Performance
Sill Option**



**High Performance
Sill Option**



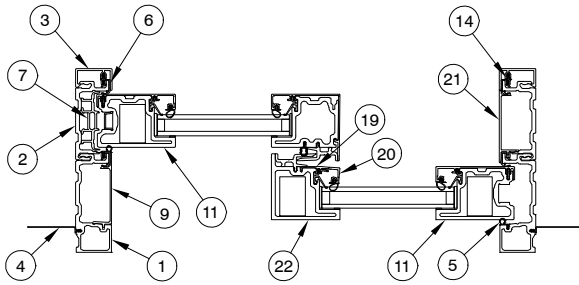
**Stationary/Pocket Panel
Head Jamb and Sill
with 1 1/4" Glass**



**Primary/Inactive Panel
Head Jamb and Sill
with 1 1/4" Glass**

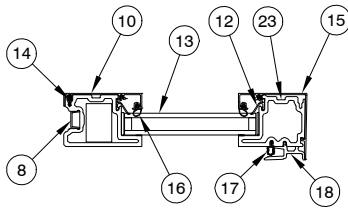
NOTE: Not to scale; specifications subject to change without notice.

Stacked Jamb Details

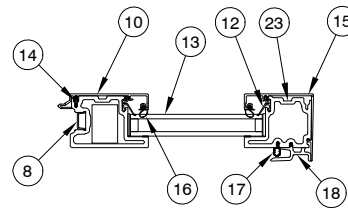


**Stacked Uni-Directional Panel
15/16" Glass
Jamb**

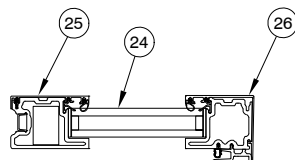
1. Exterior Frame
2. Frame
3. Frame Liner, A3248
4. Nail Fin, V2920*
5. Frame Weather Strip, V2475
6. Frame Clip, V2884
7. Jamb Filler
8. Cover, Locking Stile, V2885
9. Jamb/Head Jamb Exterior Cover, F2065
10. Clad, Locking/Stationary Stile, 15/16" Glass, A3362
11. Stile, Locking/Stationary
12. Glazing Clip, V2874
13. 15/16" Insulating Glass
14. Connecting Barb, V803
15. Clad, Interlocking Stile, 15/16" Glass, A3363
16. Interior Glazing Seal, V2949
17. Bulb Weather Strip, Sill and Panel, V2564
18. Interlock, V2875
19. Ext, Interlocking Stile Clad Connector
20. Clad, Exterior Interlocking Stile, A3365
21. Jamb/Head Jamb Interior Cover, A3244
22. Stile, Exterior Interlocking
23. Stile, Interior Interlocking
24. 1 1/4" Insulating Glass
25. Clad, Locking/Stationary Stile, 1 1/4" Glass, A3352
26. Clad, Interior Interlocking Stile, 1 1/4" Glass, A3350



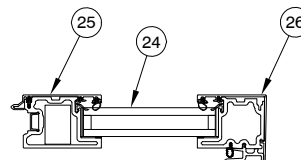
**Uni-Directional Panel
15/16" Glass
Jamb**



**Bi-Parting Panel
15/16" Glass
Jamb**



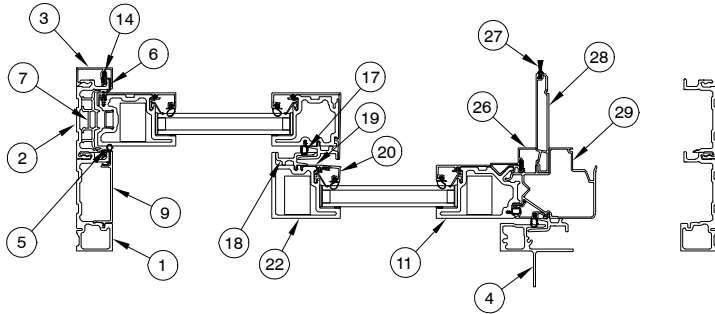
**Uni-Directional Panel
1 1/4" Glass
Jamb**



**Bi-Parting Panel
1 1/4" Glass
Jamb**

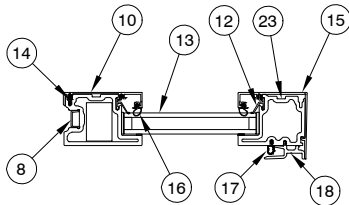
NOTE: Not to scale; specifications subject to change without notice.

**Pocket
Jamb Details**

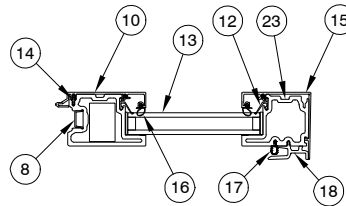


1. Exterior Frame
2. Frame
3. Frame Liner,
4. Pocket Interlock,
5. Frame Weather Strip, V2475
6. Frame Clip, V2884
7. Jamb Filler
8. Cover, Locking Stile, V2885
9. Jamb/Head Jamb Exterior Cover, F2065
10. Clad, Locking/Stationary Stile, 15/16" Glass, A3362
11. Stile, Locking/Stationary
12. Glazing Clip, V2874
13. 15/16" Insulating Glass
14. Connecting Barb, V803
15. Clad, Interlocking Stile, 15/16" Glass, A3363
16. Interior Glazing Seal, V2949
17. Bulb Weather Strip, Sill and Panel, V2564
18. Interlock, V2875
19. Ext. Interlocking Stile Clad Connector
20. Clad, Exterior Interlocking Stile, 3365
21. 1 1/4" Insulating Glass
22. Stile, Exterior Interlocking
23. Stile, Interior Interlocking
24. Clad, Locking/Stationary Stile, 1 1/4" Glass, A3352
25. Clad, Interior Interlocking Stile, 1 1/4" Glass, A3350
26. Pocket Cover Trim, A3291
27. Pile Weather Strip, V2493
28. Pocket Cover, A3293
29. Pocket Interlock Support Block, A3393

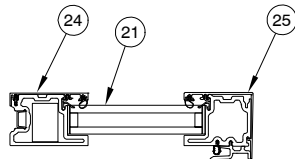
**Pocket Uni-Directional Panel
15/16" Glass
Jamb**



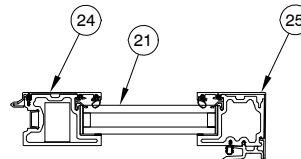
**Uni-Directional Panel
15/16" Glass
Jamb**



**Bi-Parting Panel
15/16" Glass
Jamb**



**Uni-Directional Panel
1 1/4" Glass
Jamb**



**Bi-Parting Panel
1 1/4" Glass
Jamb**

NOTE: Not to scale; specifications subject to change without notice.

Replacement Panels and Sills

To order complete Replacement Panels and/or Replacement Sills, refer to Configured Parts in OMS.

Installation Parts are available to order before the frame is installed:

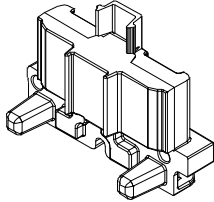
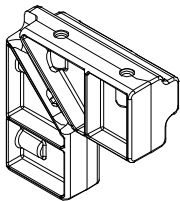
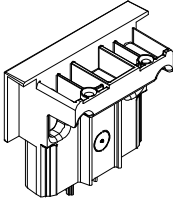
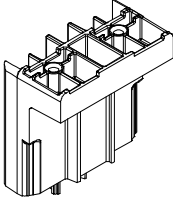
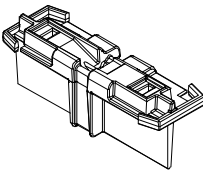
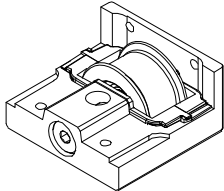
Illustration <i>Not to Scale</i>	Description	Operation	Color	Part No.
 <p>LH Part Shown</p>	<p>Sill Corner Key Includes: 1 – Key, jamb to sill 2 – #8 x 1 3/4" , TEK 2, Torx, Philips head stainless steel screw</p>	<p>LH RH</p>	<p>Black</p>	<p>11862438 11862439</p>
	<p>Exterior Frame Hollow Corner Key Kit Includes: 1 – Key, exterior frame hollow 4 – #8 x 1/2" full thread, Torx, Philips head stainless steel screw</p>		<p>Black</p>	<p>11862440</p>
	<p>Head Jamb Corner Key Kit Includes: 1 – Key, jamb to head jamb 4 – #8 x 1/2" full thread, Torx, Philips head stainless steel screw</p>		<p>Black</p>	<p>11862441</p>
	<p>Head Jamb Corner Key, Exterior Includes: 1 – Key, jamb to head jamb, exterior 4 – #8 x 1/2" full thread, Torx, Philips head stainless steel screw</p>		<p>Black</p>	<p>11862442</p>
	<p>Exterior Frame Hollow Splice Key Includes: 1 – Key, splice, frame, exterior 2 – #8 x 1/2" full thread, Torx, Philips head stainless steel screw</p>		<p>Black</p>	<p>11862443</p>
	<p>Key, Pulley, Assembly Includes: Pulley corner key, pulley housing, shoulder screw and pulley idler assembly</p>			<p>10501900</p>

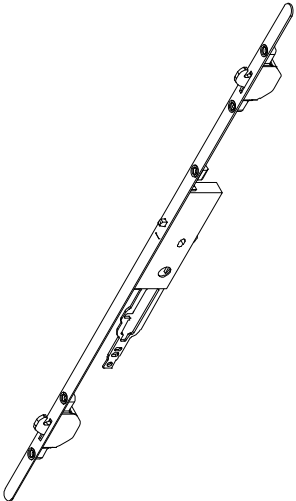
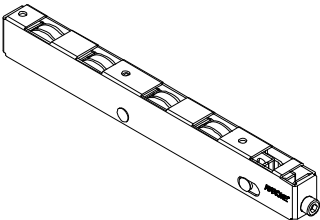
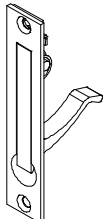
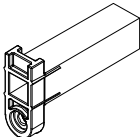
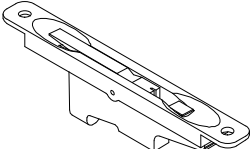
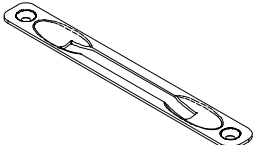
Illustration <i>Not to Scale</i>	Description	Operation	Color	Part No.
	<p>Lock Box, Hoppe Kit Includes: 1 - Lock Box 7 - #7-19 x 7/8" Type AB Phillips head screws</p>			11862430
	<p>Roller, Hoppe (Series 360) Kit Includes: 1 - Roller 2 - #8-19 x 1/2" Torx Phillips head screws</p>		Stainless Steel	11862431
	<p>Edge Pull Kit Includes: 1 - Edge Pull 2 - #7-19 x 7/8" Type AB Phillips head screws</p>		Satin Chrome	11862432
	<p>Shoot Bolt Guide Uses: 1 - #8 x 5/8" Phillips pan head screw (11800498)</p>			10501544
	<p>Flush Bolt Assembly Uses: 2 - #7 -19 x 7/8" Type AB, full thread, P2, Phillips head, stainless steel screw (11800777)</p>			11101780
	<p>Flush Bolt Trim Cover Includes: 1 - Flush Bolt Trim Cover 2 - #7 -19 x 7/8" Type AB, full thread, P2, Phillips head, stainless steel screw</p>			11862433

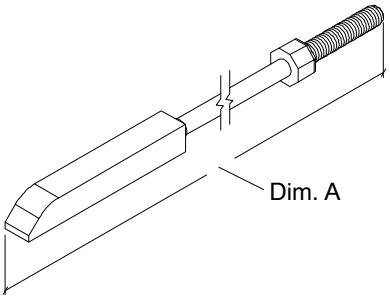
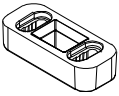
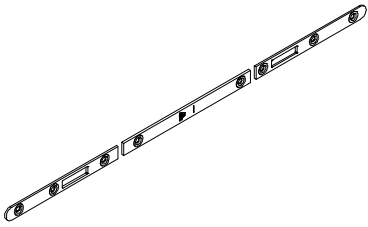
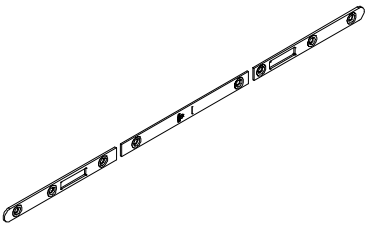
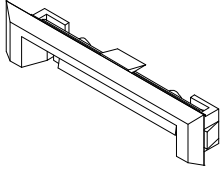
Illustration <i>Not to Scale</i>	Description	Operation	Color	Part No.
	<p>Flush Bolt Rod</p> <p>11 1/32" 27 1/32" 34 9/32" 41 15/16" 51 7/16" 63 7/16"</p>			<p>05700180 05700185 05700170 05700177 05700179 05700191</p>
	<p>Shoot Bolt Strike Kit <i>Includes:</i> 1 - Strike, shoot bolt 2 - #10-12 x 3" 2/3 thread Phillips head screws</p>		Black	11862425
	<p>Panel Strike, Hoppe Kit <i>Includes:</i> 1 - Strike 7 - #7-19 x 7/8" Type AB Phillips head screws</p>		Stainless Steel	11862434
	<p>Jamb Strike, Hoppe Kit <i>Includes:</i> 1 - Strike 3 - #8-18 x 1/2" Type AB Phillips head screws 4 - #8-15 x 3" 2/3 thread Phillips head screws</p>		Stainless Steel	11862435
	<p>Weep Hole Cover</p>		Black	10501004

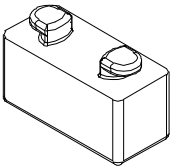
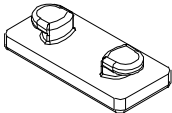
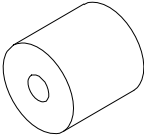
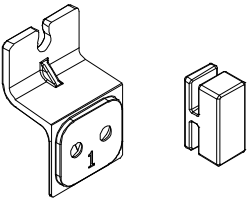
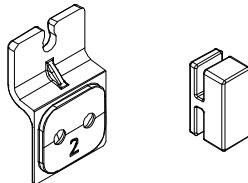
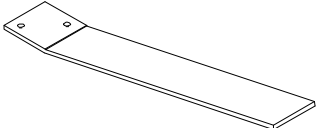

Illustration <i>Not to Scale</i>	Description	Operation	Color	Part No.
	<p>Bumper, .532"</p>			<p>10501592</p>
	<p>Bumper, .125"</p>			<p>10501591</p>
	<p>Pocket Bumper Kit <i>Includes:</i> 2 - Bumper, pocket jamb 2 - #10-12 x 3" Torx T25, 2/3 thread Phillips head screws</p>		<p>Black</p>	<p>11862429</p>
	<p>Panel Bumper Kit, (panel A to panel B) <i>Includes:</i> 2 - Bumper, secondary to primary 2 - Bumper, .375" 4 - #10-16 x 1 1/2" P2 flathead, full thread, TEK 2 screws</p>		<p>Black</p>	<p>11862427</p>
	<p>Panel Bumper Kit, (panel B to panel B) <i>Includes:</i> 2 - Bumper, secondary to secondary 2 - Bumper, .375" 4 - #10-16 x 1 1/2" P2 flathead, full thread, TEK 2 screws</p>		<p>Black</p>	<p>11862428</p>
	<p>Pocket Cover Support Bracket Kit <i>Includes:</i> 2 - Pocket support cover brackets 4 - #8-18 x 7/16" TEK 2, full thread Phillips pan head screws</p>		<p>Aluminum</p>	<p>11862426</p>
	<p>Dust Block <i>Adhesive backed</i> 1 3/8" x 3/8" x 1/2"</p>		<p>Black</p>	<p>15600009</p>

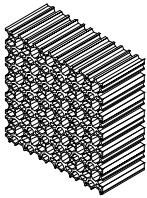
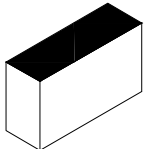
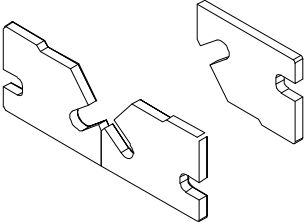
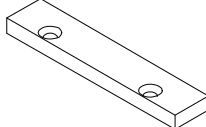
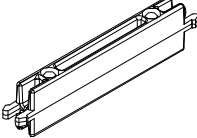
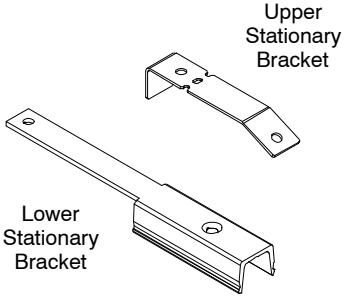
Illustration <i>Not to Scale</i>	Description	Operation	Color	Part No.
	Drain Filter, Sill		Black	10500240
	Gasket, Head Jamb Part Stop		Black	10500436
	Gasket, Pocket Interlock		Black	10501546
	Sill Liner Splice Key Flush Performance, Kit <i>Includes:</i> 1 - Splice key 2 - #8-18 x 1/2", Type AB, full thread, Phillips head, stainless steel screw		Black	11862436
	Sill Liner Splice Key High Performance, Kit <i>Includes:</i> 1 - Splice key, High Performance 2 - #8-18 x 1/2", Type AB, full thread, Phillips head, stainless steel screw		Black	11862437
 <p>Upper Stationary Bracket</p> <p>Lower Stationary Bracket</p>	Stationary Bracket Kit <i>Includes:</i> 1 - Upper stationary bracket 1 - #10-12 x 3", Torx T25, Philips 2/3 thread screw 1 - #8 x 1", TEK 3, full thread, P2, Phillips pan head head screw 2 - Lower stationary bracket 1 - #8-18 x 7/16" TEK-2 Phillips, full thread, pan head screw 1 - #8-18 x 1 1/2", 2/3 thread, A/TF flat head screw		Aluminum	11862424

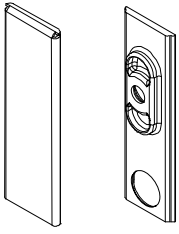
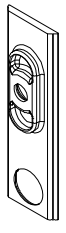
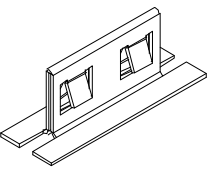
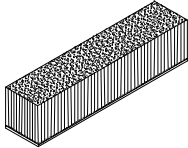
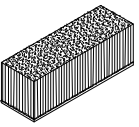
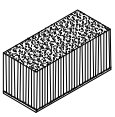

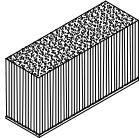





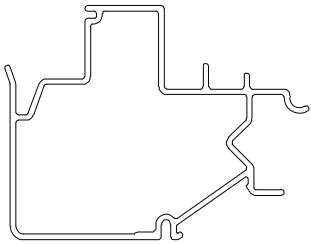

Illustration <i>Not to Scale</i>	Description	Operation	Color	Part No.
	<p>Stile Hole Cover, Exterior, Kit Includes: 2 – Stile hole covers 2 – Cover retainer bracket 2 – #8-18 x 1 3/4" full thread pan head screw (11808176)</p>		<p>Bronze Ebony Gunmetal Silver Stone White</p>	<p>11862444 11862445 11862446 11862447 11862448</p>
	<p>Cover Retainer Bracket Uses: 1 – #8-18 x 1 3/4" full thread pan head screw (11808176)</p>		<p>Black</p>	<p>10501594</p>
	<p>Dust Block Holder, Interior</p>		<p>Black</p>	<p>10500725</p>
	<p>Dust Block, Interior</p>		<p>Black</p>	<p>10500483</p>
	<p>Bi Part Inactive Stile Seal</p>		<p>Black</p>	<p>10500443</p>
	<p>Bi Part Locking Stile Seal</p>		<p>Black</p>	<p>10500448</p>
	<p>Bi Part Locking Panel Shoe Seal</p>		<p>Black</p>	<p>10500449</p>
	<p>Bi-Parting Sill Seal</p>		<p>Black</p>	<p>10500482</p>

Illustration <i>Not to Scale</i>	Description	Length	Color	Part No.
	Jamb Cover, Interior A3244	200 (5080)"	Gunmetal Stone White Bronze Clear Anodize Ebony	18818170 18818165 18818160 18818155 18818150
	Frame Liner (Head Jamb and Jamb) A3248	200 (5080)"	Gunmetal Stone White Bronze Clear Anodize Ebony	18818120 18818115 18818110 18818105 18818100
	Clad, Locking/Stationary Stile 15/16" Glass A3362	200 (5080)"	Gunmetal Stone White Bronze Clear Anodize Ebony	18818220 18818215 18818210 18818205 18818200
	Clad, Locking/Stationary Stile 1 1/4" Glass A3349	200 (5080)"	Gunmetal Stone White Bronze Clear Anodize Ebony	188189420 188189415 188189410 188189405 188189400
	Trim, Pocket, 1 Deep A3312	200 (5080)"	Gunmetal Stone White Bronze Clear Anodize Ebony	18818870 18818865 18818860 18818855 18818850
	Pocket Interlock Support Block A3313	200 (5080)"	Black	188188900
	Sill Track Cover A2736	200 (5080)"	Ebony Bronze	18818050 18818060

When ordering replacement Modern Multi-Slide Door aluminum parts, specify:

1. Order number/line number (if available)
2. Type of unit
3. Description
4. Color
5. Length



A2863
Sill Liner Nosing, HP



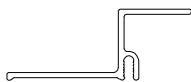
A2736
Sill track Cover



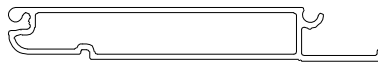
A3244
Cover, Jamb,
Interior



A3248
Liner, Frame
(Head Jamb and Jamb)



A3291
Trim,
Pocket Cover



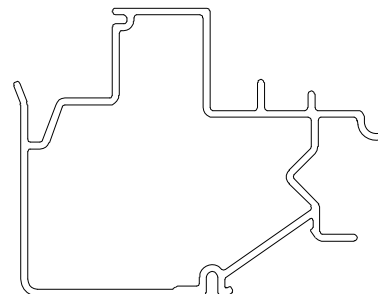
A3292
Cover, Pocket,
Modular



A3293
Cover, Pocket



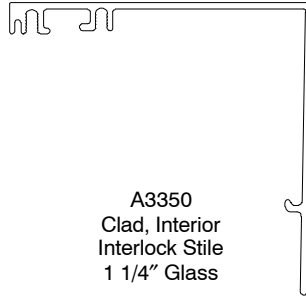
A3312
Trim, Pocket,
1 Deep



A3313
Pocket
Interlock Support Block



A3349
Clad,
Locking/Stationary Stile
1 1/4" Glass



A3350
Clad, Interior
Interlock Stile
1 1/4" Glass



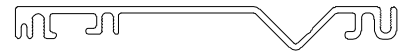
A3351
Clad, Exterior
Interlock Stile
1 1/4" Glass



A3352
Clad, Locking Stile
Bi-Parting
1 1/4" Glass



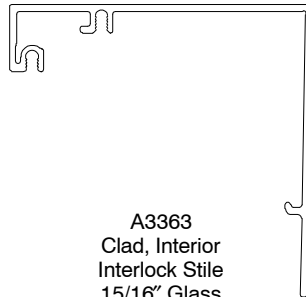
A3354
Clad, Inactive Stile
1 1/4" Glass



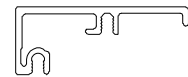
A3355
Clad, Pocket Stile
1 1/4" Glass



A3362
Clad,
Locking/Stationary Stile
15/16" Glass



A3363
Clad, Interior
Interlock Stile
15/16" Glass



A3365
Clad, Exterior
Interlock Stile
15/16" Glass



A3366
Clad, Locking Stile
Bi-Parting
15/16" Glass



A3367
Clad, Inactive Stile
15/16" Glass



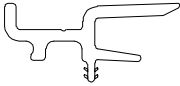
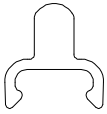
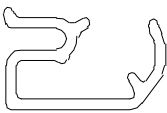
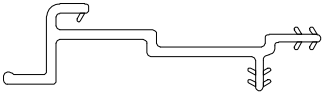
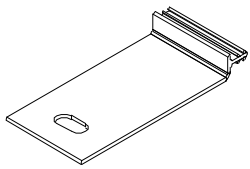
A3368
Clad, Pocket Stile
15/16" Glass

When ordering replacement Modern Multi-Slide Door High-Density fiberglass parts, specify:

1. Order number/Line Number (if available)
2. Type of unit
3. Description
4. Color
5. Length

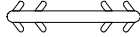


F2065
Cover,
Jamb/Head Jamb,
Exterior

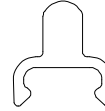
Illustration <i>Not to Scale</i>	Description	Length	Color	Part No.
	Interlock V2875	203" (5156)	Black	16219215
	Roller Track V2426	150" (3810)	Black	15984899
	Clip, Frame V2884	203" (5156)	Black	16219210
	Glazing Bead V2917	3" (76)	Black	15221405
	Nail Fin, Jamb V2920	150"	Gray	16219199

When ordering replacement Multi-Slide Door vinyl parts, specify:

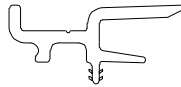
1. Order number/Line Number (if available)
2. Type of unit
3. Description
4. Length




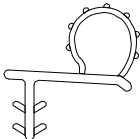

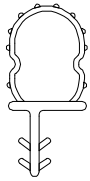
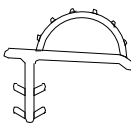
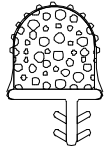
V803, Connecting Barb



V2426, Roller Track



V2875, Interlock

Illustration <i>Not to Scale</i>	Description	Operation	Color	Part No.
	Weather Strip, 1/2 Pile V2493 500" roll		Black	11209999
	Weather Strip, Jamb, Bulb V2475 144"		Black	11209699
	Interior Glazing Seal V2949 200" (5080)		Black	16219235
	Weather Strip, Sill and Panel, Bulb V2564 150" (3810)		Black	11211299
	Weather Strip, Head Jamb V2977 200 (5080)"		Black	16219275
	Weather Strip, Frame V1419 150 (3810)"		Black	15360799






When ordering replacement screen parts, specify:

1. Order number/Line Number (if available)

NOTE: Single screen: Order number is found under the bottom stile cover on the opposite side of the tensioning springs.

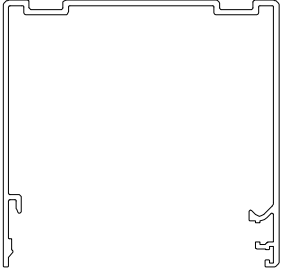

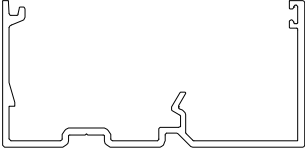
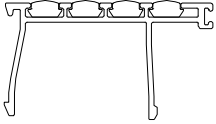
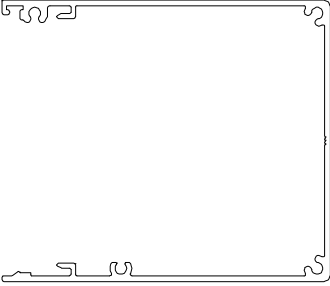

NOTE: Double screen: Order number is found under the bottom left hand stile cover on the opposite side of the tensioning springs (left hand when viewing from the exterior).

Illustration <i>Not to Scale</i>	Description	Oper.	Color	Part No.
	Top Cartridge Bearing <i>Includes:</i> 1 - Cable tensioner 1 - Top block side pulley/bearing 4 - Screws	LH RH	Black	10501287 10501288
	Bottom Handle Pull Assembly <i>Includes:</i> 1 - Bottom stile cap 2 - Screw/cable crimp	LH RH	Black	10501289 10511290
	Top Handle Pull Assembly <i>Includes:</i> 1 - Top stile cap 2 - Screw/cable crimp	LH RH	Black	10501291 10501292
	Spool Kit <i>Includes:</i> 1 - LH/RH Cone 1 - Cable crimp 1 - Cable connector 4 - Screws	LH RH	Black Gray	10501293 10501294

Illustration <i>Not to Scale</i>	Description	Oper.	Color	Part No.
	Cable			10501295
	Bi-Parting Screen Stop <i>Includes:</i> 1 - Double screen stop		Black	10501296
	Handle Pull Covers/Spring Kit <i>Includes:</i> 4 - Stile covers 2 - Springs 4 - Spring keepers			10501297
	Bottom Cartridge Bearing <i>Includes:</i> 1 - Bottom bearing 2 - Screws	LH RH		10501299 10501298
	Cartridge <i>Includes:</i> 1 - complete cartridge assembly	LH RH		

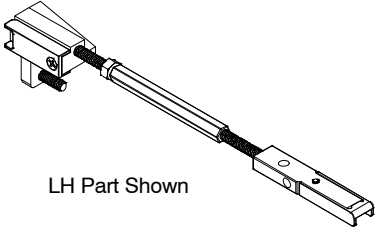
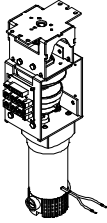
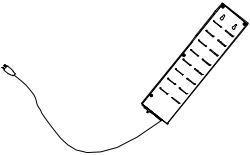
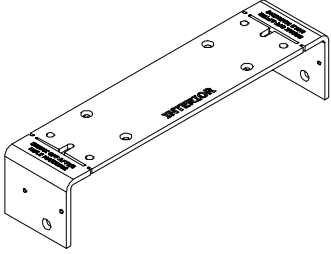
When ordering replacement aluminum screen parts, specify:

1. Order number/Line number (if available)
2. Total rough opening
3. Part length
4. Handing
5. Finish (if applicable)

<p>Illustration <i>Not to Scale</i></p>	<p>Description</p>	<p>Color</p>
	<p>Head Jamb Frame <i>Includes:</i> 1 - Weather strip</p>	<p>Bronze White Clear Anodize Black Gunmetal</p>
	<p>Head Jamb/Jamb Cover <i>Includes:</i> 1 - Weather strip</p>	<p>Bronze White Clear Anodize Black Gunmetal</p>
	<p>Sill <i>Includes:</i> 1 - Weather strip</p>	<p>Bronze White Clear Anodize Black Gunmetal</p>
	<p>Sill Cover with Rubber Insert <i>Includes:</i> 1 - Weather strip</p>	<p>Bronze White Clear Anodize Black Gunmetal</p>
	<p>Jamb Frame <i>Includes:</i> 1 - Weather strip</p>	<p>Bronze White Clear Anodize Black Gunmetal</p>
	<p>Jamb Stop <i>Includes:</i> 1 - Magnet strip</p>	<p>Bronze White Clear Anodize Black Gunmetal</p>

When ordering replacement automatic control parts, specify:

1. Order number/Line Number (if available)

Illustration <i>Not to Scale</i>	Description	Operation	Color	Part No.
 <p>LH Part Shown</p>	Turnbuckle Assembly	LH RH	Black	10501901 10501902
	Motor		Black	10501275
	Motor Controller <i>Includes:</i> 1 - Motor controller 1 - Power cord 1 - 10-pin motor cable			10501276
	Motor Bracket		Aluminum	10501278

Automatic Control Parts

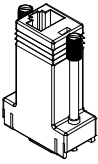
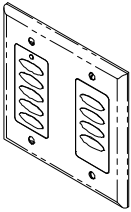
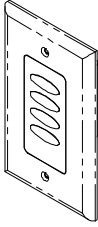
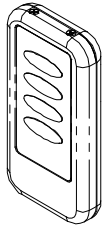
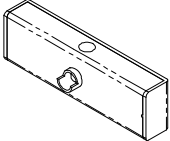
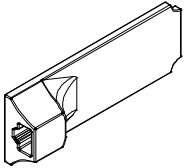
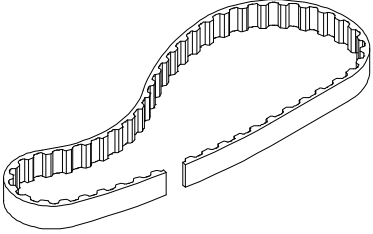
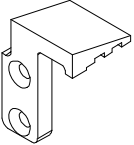
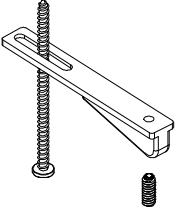
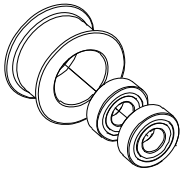
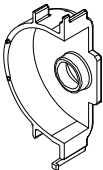
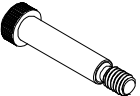
Illustration <i>Not to Scale</i>	Description	Operation	Color	Part No.
	Home Automation Adaptor		Black	10501270
	Wired Wall Switch, Keypad, Exterior <i>Includes:</i> 1 - Dual switch 1 - Security interface board 1 - Short connecting cable 1 - Dual switch cover 1 - Exterior weather strip		White	10501269
	Wireless Wall Switch <i>Includes:</i> 1 - Wireless wall switch 1 - Cover plate		Black Light Almond White Ivory	10501279 10501280 10501281 10501263
	Wired Wall Switch <i>Includes:</i> 1 - Wired wall switch 1 - Cover plate		Black Light Almond White Ivory	10501264 10501267 10501266 10501265
	Remote Control		Black	10501282
	Wireless Motion Sensor		Black White	10501283 10501284
	Wireless Receiver		Black	10501268

Illustration <i>Not to Scale</i>	Description	Operation	Color	Part No.
	<p>Belt Includes: 1 - Belt <i>NOTE: Order by LF-belt calculation is frame width x 2 + 4'</i></p>		Black	10501271
	<p>Belt Clamp Bracket, Bi-Parting</p>	LH RH	Black	10501905 10501906
	<p>Closing Ramp Includes: 1 - Bracket 2 - #8-18 x 3" type AB, Phillips head, full thread screw (11806168)</p>			10501304
	<p>Pulley, Idler, Assembly Includes: 1 - Pully 2 - Bearings</p>		Black	10501904
	<p>Pulley Housing</p>		Black	10501895
	<p>Shoulder Screw, Pulley</p>		Black	11830017

Lock Status Sensor Parts

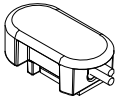
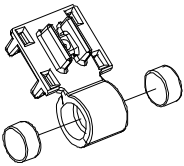
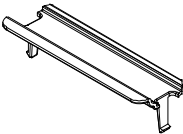
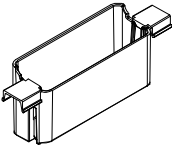
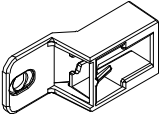
Illustration <i>Not to Scale</i>	Description	Operation	Color	Part No.
	Reed Capsule Assembly		Black	10501846
	Magnet Assembly Housing		Black	10815371
	Transmitter Cover		Black	10501898
	Transmitter Housing		Black	10501896
	Bracket, Sensor <i>Uses:</i> 1 - #8-18 x 7/16" TEK-2 Phillips, full thread, pan head screw (11800177)		Black	10501899

Illustration <i>Not to Scale</i>	Description	Operation	Color	Part No.
	Touch Up Paint, .6 oz.		Ebony Bronze Gunmetal Stone White Silver	01530353 01530354 01530355 01530356 01530357
	Putty, Minute Mend, 2 oz.			11410007