

# MODERN DIRECT GLAZE

## Table of Contents

	Page
History .....	2
Part Identification – Rectangle, Polygon and Mull .....	3
Aluminum Parts .....	4
Vinyl Parts .....	6
Repair Items .....	8

### **ATTENTION:**

- Specification and technical data are subject to change without notice.

# History

---

PRODUCED	UNIT TYPE	FEATURES OR CHANGES	STATUS
2018	Direct Glaze	2018-10-29 - Introduced the Modern Direct Glaze Window.	Present

## Direct Glaze Rectangle 15/16" Glass

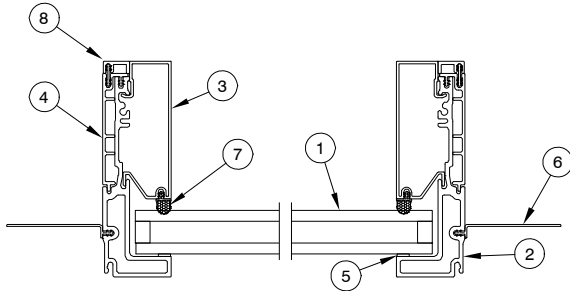

1. 15/16" Insulating Glass
2. Exterior Frame
3. Glazing Stop, A3357
4. Shim Block
5. Glazing Tape
6. Nail Fin, V2920
7. Interior Glazing Seal, Rectangle, V1419
8. Interior Trim, A3316 (optional)

## Direct Glaze Rectangle 1 1/4" Glass

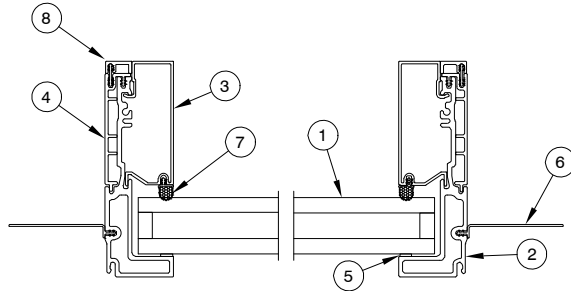

1. 1 1/4" Insulating Glass
2. Exterior Frame
3. Glazing Stop, A3358
4. Shim Block
5. Glazing Tape
6. Nail Fin, V2920
7. Interior Glazing Seal, Rectangle, V1419
8. Interior Trim, A3316 (optional)

## Direct Glaze Polygon 15/16" Glass

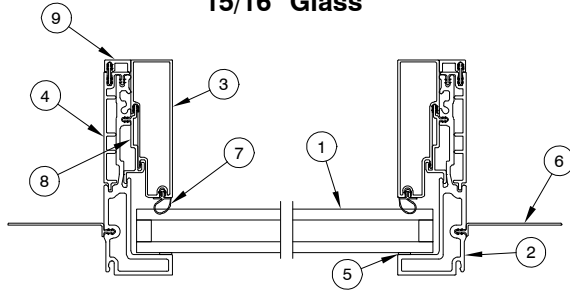

1. 15/16" Insulating Glass
2. Exterior Frame
3. Glazing Stop, A3359
4. Shim Block
5. Glazing Tape
6. Nail Fin, V2920
7. Interior Glazing Seal, Polygon, V2949
8. Glazing Bead, Polygon, V2917
9. Interior Trim, A3316 (optional)

## Direct Glaze Polygon 1 1/4" Glass

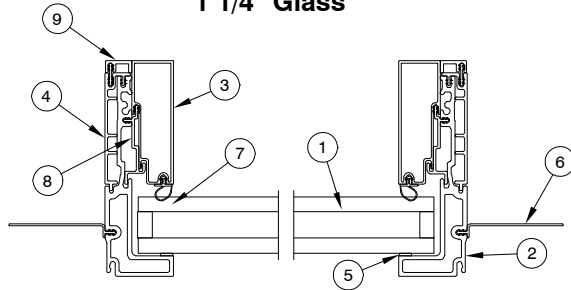



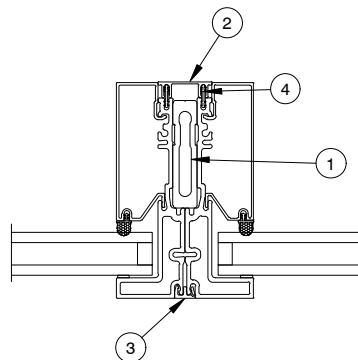

1. 1 1/4" Insulating Glass
2. Exterior Frame
3. Glazing Stop, A3360
4. Shim Block
5. Glazing Tape
6. Nail Fin, V2920
7. Interior Glazing Seal, Polygon, V2949
8. Glazing Bead, Polygon, V2917
9. Interior Trim, A3316 (optional)

## Vertical Mull

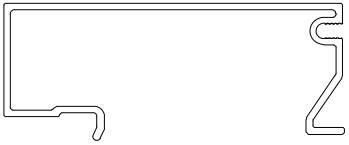
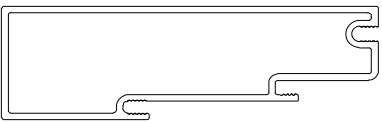
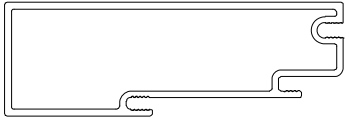

1. Mull Pin, A3398
2. Mull Cover, Interior, A3315
3. Mull Cap, A3422
4. Connecting Barb, V803

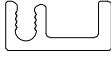
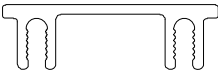
NOTE: Not to scale; specifications subject to change without notice.

Illustration <i>Not to Scale</i>	Description	Length	Color	Part No.
	<b>Glazing Stop, Rectangle 15/16" Glass A3357</b>	200" (5080)	Gun Metal Stone White Bronze Clear Anodize Ebony	18819020 18819015 18819010 18819005 18819000
	<b>Glazing Stop, Rectangle 1 1/4" Glass A3358</b>	200" (5080)	Gun Metal Stone White Bronze Clear Anodize Ebony	18819170 18819165 18819160 18819155 18819150
	<b>Glazing Stop, Polygon 15/16" Glass A3359</b>	200" (5080)	Gun Metal Stone White Bronze Clear Anodize Ebony	11819120 11819115 11819110 11819105 11819100
	<b>Glazing Stop, Polygon 1 1/4" Glass A3360</b>	200" (5080)	Gun Metal Stone White Bronze Clear Anodize Ebony	18819220 18819215 18819210 18819205 18819200
	<b>Mull Cap, Exterior A3422</b>	200" (5080)	Gun Metal Stone White Bronze Clear Anodize Ebony	18819870 18819865 18819860 18819855 18819850
	<b>Trim, Interior A3316</b>	200" (5080)	Gun Metal Stone White Bronze Clear Anodize Ebony	18819120 18819115 18819110 18819105 18819100
	<b>Mull Cover, Interior A3315</b>	200" (5080)	Gun Metal Stone White Bronze Clear Anodize Ebony	18819070 18819065 18819060 18819055 18819050
	<b>Mull Pin A3398</b>	200" (5080)		118191555

**When ordering replacement Modern Direct Glaze aluminum parts specify:**

1. Order number/Line Number (if available)
2. Type of unit
3. Description
4. Color
5. Length



A3316, Trim,  
Interior

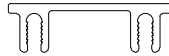

A3315, Mull Cover,  
Interior



A3422, Mull Cap,  
Exterior



A3357, Glazing Stop,  
Rectangle, 15/16" Glass



A3358, Glazing Stop,  
Rectangle, 1 1/4" Glass

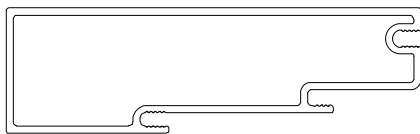

A3359, Glazing Stop,  
Polygon, 15/16" Glass

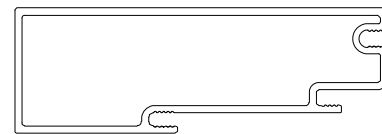

A3360, Glazing Stop,  
Polygon, 1 1/4" Glass

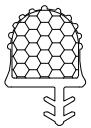
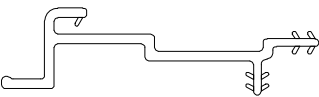
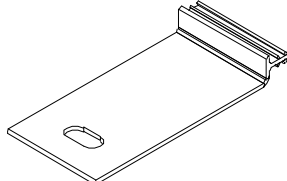
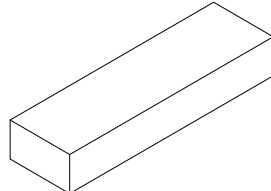
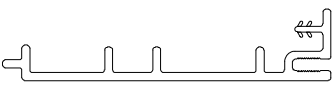

A3398, Mull Pin

Illustration <i>Not to Scale</i>	Description	Length	Color	Part No.
	<b>Interior Glazing Seal</b> V2949	200" (5080)	Black	16219235
	<b>Interior Glazing Seal, Rectangle</b> V1419	150" (5080)	Black	15360799
	<b>Glazing Bead</b> V2917	3" (76)	Black	15221405
	<b>Nail Fin</b> V2920			16219199
	<b>Foam Pad, Mull Seal</b>		Gray	15350091
	<b>Shim Block</b> V2916	3" (76)	Gray	15221406

**When ordering replacement Modern Direct Glaze vinyl parts specify:**

1. Order number/Line Number (if available)
2. Type of unit
3. Description

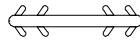

V803, Connecting Barb

<b>Illustration</b> <i>Not to Scale</i>	<b>Description</b>	<b>Operation</b>	<b>Color</b>	<b>Part No.</b>
	<b>Touch Up Paint, .6 oz.</b>		Ebony Bronze Gunmetal Stone White Silver	01530353 01530354 01530355 01530356 01530357
	<b>Putty, Minute Mend, 2 oz.</b>			11410007