

# MODERN CASEMENT Crank Out

## Table of Contents

	Page
History .....	2
Part Identification – Unit .....	3
Part Identification – Mulling .....	4
Hardware Parts .....	5
Aluminum Parts .....	9
Vinyl Parts .....	10
Screen Parts .....	11
Replacement Sash and Screens are available through OMS	

NOTE: See Modern Accessories chapter for various items for Mulling, Installation and Repair

### **ATTENTION:**

- Specification and technical data are subject to change without notice.

# History

---

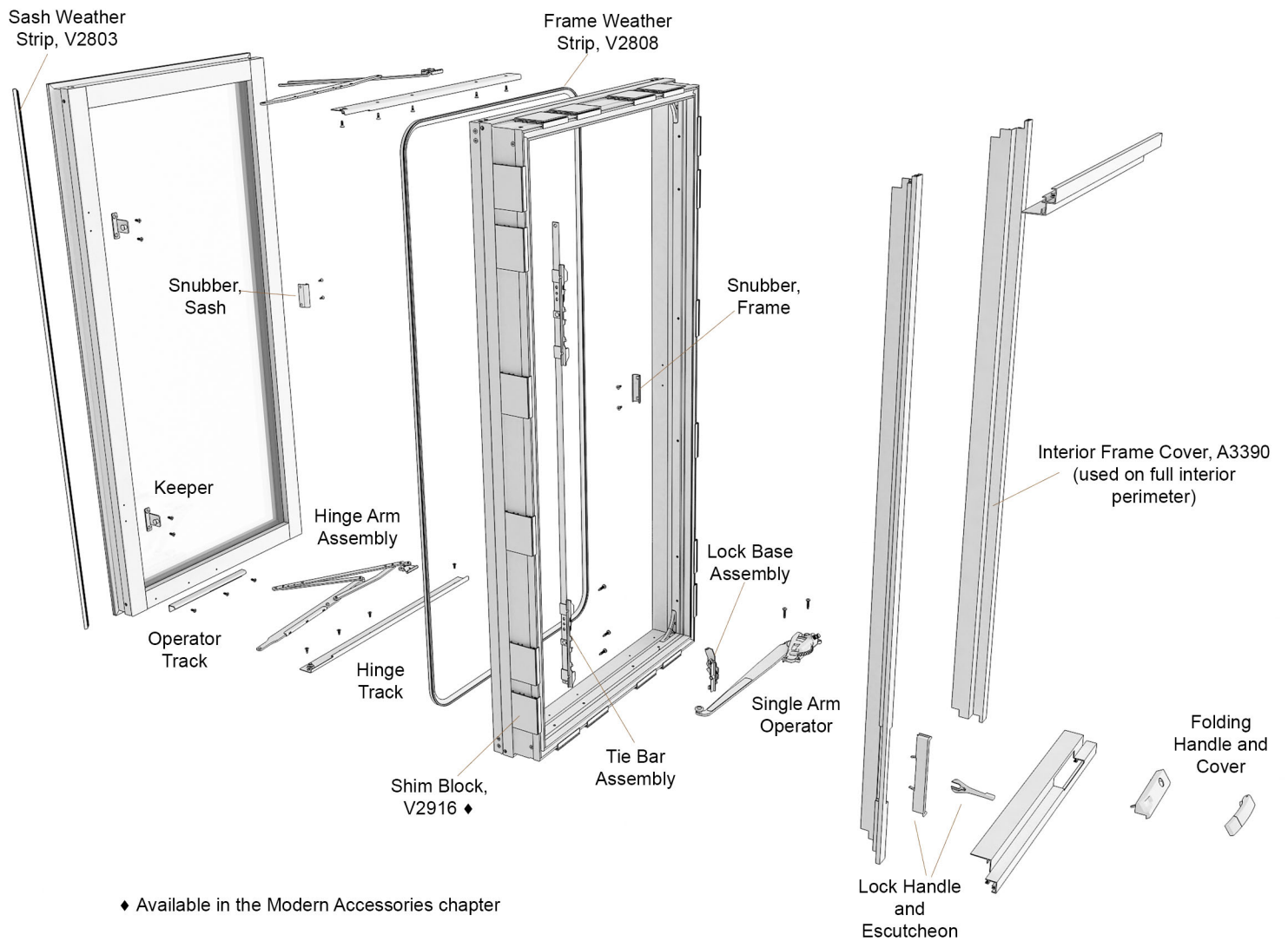

PRODUCED	UNIT TYPE	FEATURES OR CHANGES	STATUS
2019	Casement Crank Out	2019-04-29 – Introduced the Modern Casement Crank Out	Present

Modern Casement Crank Out  
**Part Identification – Unit**

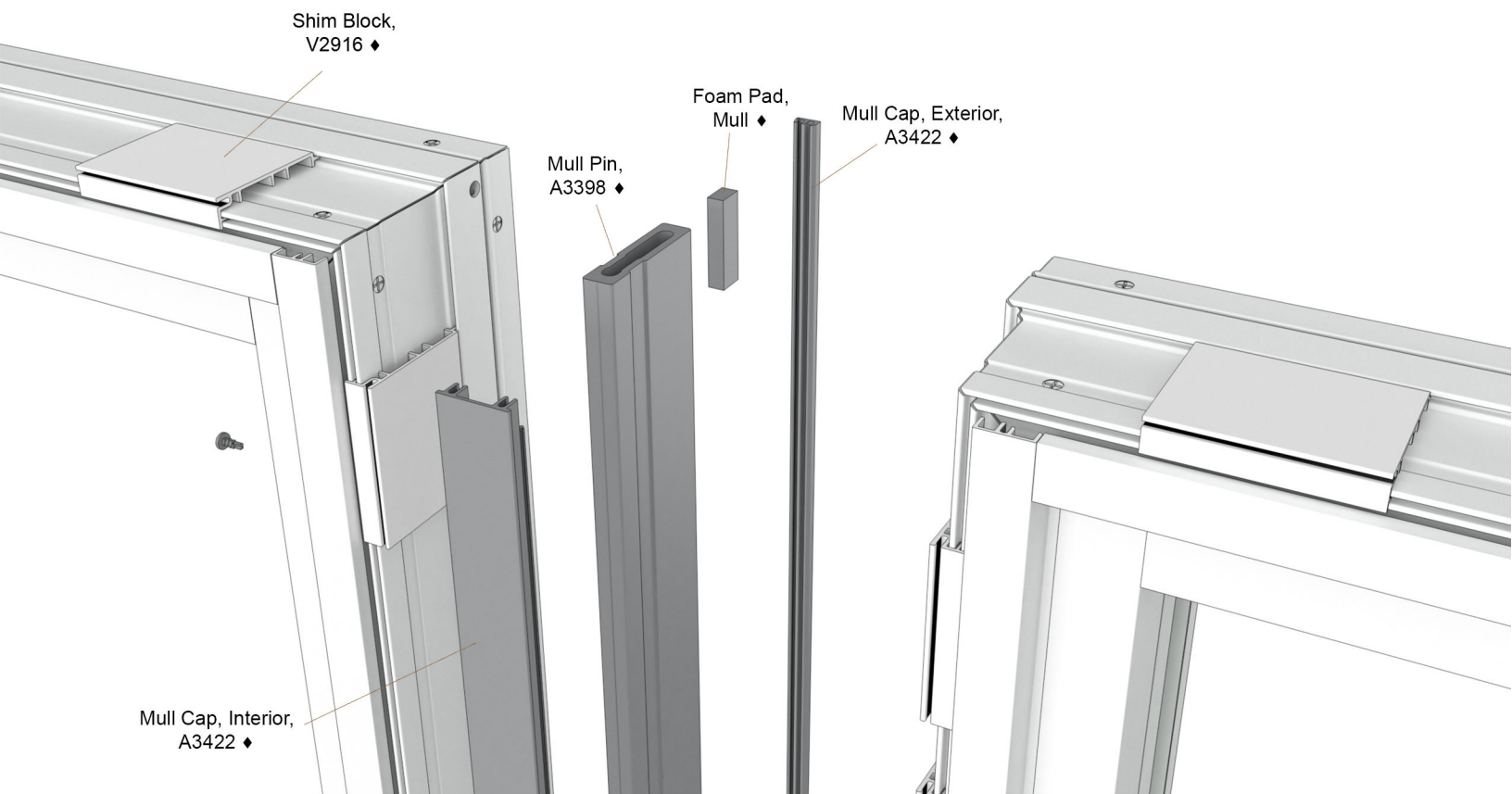

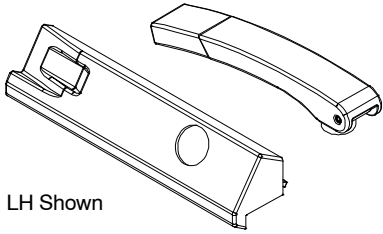

♦ Available in the Modern Accessories chapter

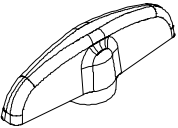
<b>Illustration</b> <i>Not to Scale</i>	<b>Description</b>	<b>Color/Length</b>	<b>LH Part No.</b>	<b>RH Part No.</b>
 <p>LH Shown</p>	<b>Folding Handle and Cover</b>			
		Matte Black	10816475	10816476
		Matte Bronze	10816477	10816478
		Satin Nickel	10816479	10816480
		Silver	10816481	10816482
	Stone White	10816483	10816484	
<b>Illustration</b> <i>Not to Scale</i>	<b>Description</b>	<b>Length</b>	<b>Color</b>	<b>Part No.</b>
	<b>Set Screw, Folding Handle</b>	---	Black	10816485
	<b>T-Handle, Operator</b> (Construction Handle only)	---	---	10898670

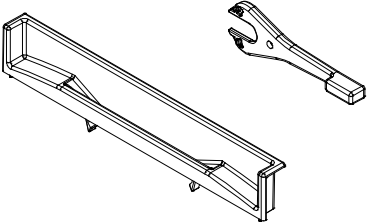
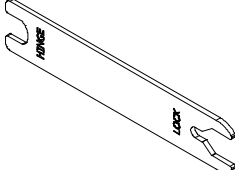
<b>Illustration</b> <i>Not to Scale</i>	<b>Description</b>	<b>Color</b>	<b>Part No.</b>
	<b>Lock Handle and Escutcheon</b>		
		Matte Black	10816465
		Matte Bronze	10816466
		Satin Nickel	10816467
		Silver	10816468
	Stone White	10816469	
	<b>Lock Handle Wrench</b>	---	10810020

<b>Illustration</b> <i>Not to Scale</i>	<b>Description</b>	<b>Color</b>	<b>Part No.</b>
	<b>Sash Limiter Kit, Custodial</b> <i>Includes:</i> 1 – Sash Limiter and Track Assembly 4 – #8 x 15 x 3/8" Torx screw 1 – Torx tamper-proof custodial bit 1 – Field installation instruction	---	11850750
	<b>T20 Torx Tamper-Proof Custodial Bit</b>	---	02071481
 <p>Frame Snubber</p> <p>Sash Snubber</p>	<b>Snubber Replacement Kit</b> <i>Includes:</i> 4 – Frame snubber 4 – Sash snubber 16 – #8 x 15 x 1/2" type AB, Phillips, flat head, stainless steel screws	Stainless Steel	11862479
	<b>Keeper Kit</b> <i>Includes:</i> 1 – Keeper 2 – #8 x 15 x 1/2" type AB, Phillips, flat head, stainless steel screws	Stainless Steel	11862716

Illustration <i>Not to Scale</i>	Description	Color/Length	LH Part No.	RH Part No.
 <p>LH Shown</p>	<b>Single Arm Operator Kit</b> <i>Includes:</i> 1 - Single arm operator 2 - #8-10 x 3/4" full thread, Phillips, pan head, stainless steel screws			
	For frame width 20.000" - 24.000"	Silver 10"	11862747	11862750
	For frame width 24.001" - 30.000"	Silver 14"	11862748	11862751
	For frame width 30.001" - 44.000"	Silver 18"	11862749	11862752
 <p>LH Shown</p>	<b>Operator Track Kit</b> <i>Includes:</i> 1 - Operator track 3 - #8-15 x 1/2" type AB, Phillips, flat head, stainless steel screws			
		Stainless Steel 9"	11862728	11862729
 <p>LL/UR Shown</p>	<b>Hinge Arm Kit</b> <i>Includes:</i> 1 - Hinge arm 4 - #8-15 x 1/2" type AB, Phillips, flat head, stainless steel screws			
	For frame width 20" (508) - 44" (1118)	Stainless Steel 18"	11862700	11862701
 <p>LL/UR Shown</p>	<b>Hinge Track Kit</b> <i>Includes:</i> 1 - Hinge track 4 - #8-15 x 1/2" type AB, Phillips, flat head, stainless steel screws			
	For frame width 20" (508) - 44" (1118)	Stainless Steel 18"	11862702	11862703

**Tie Bar Assembly Kit**

*Includes:*

*#8-15 x 1/2" type AB, Phillips, flat head, stainless steel screws  
 (see below for quantity included)*

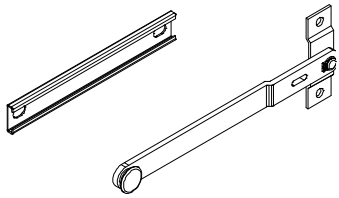
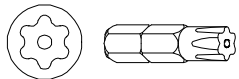
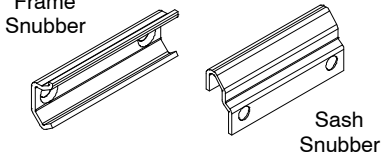
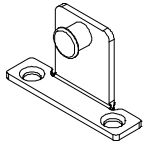
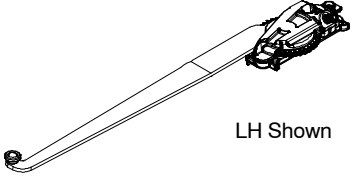
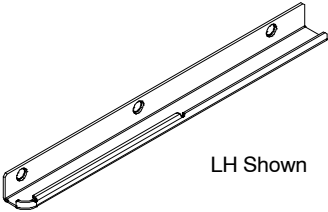
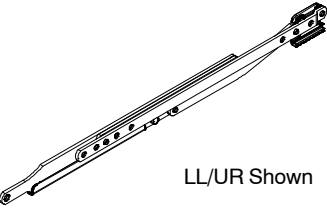
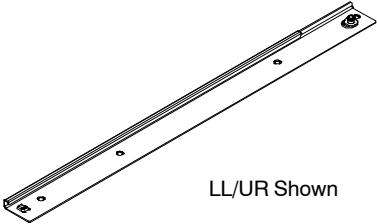
Lock Base Assembly (shown  
 for illustrative purposes only –  
 Must be ordered separately)

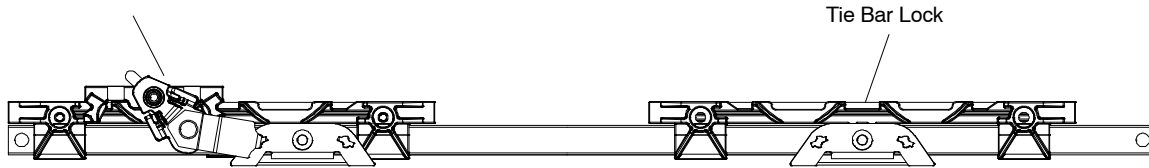
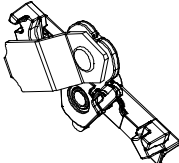

Illustration not to scale

Description	Color	Length	LH Part No.	RH Part No.
For frame height 16.000" – 18.499" (includes 2 screws)	E-Gard	7 1/2"	11862733	11862734
			<b>Part No.</b>	
For frame height 18.500" – 31.999" (includes 2 screws)	E-Gard	10"	11862735	
For frame height 32.000" – 37.999" (includes 4 screws)	E-Gard	23 1/2"	11862736	
For frame height 38.000" – 43.999" (includes 4 screws)	E-Gard	29 1/2"	11862737	
For frame height 44.000" – 49.999" (includes 4 screws)	E-Gard	35 1/2"	11862738	
For frame height 45.000" – 55.999" (includes 4 screws)	E-Gard	41 1/2"	11862740	
For frame height 56.000" – 61.999" (includes 6 screws)	E-Gard	47 1/2"	11862741	
For frame height 62.000" – 67.999" (includes 6 screws)	E-Gard	53 1/2"	11862742	
For frame height 68.000" – 73.999" (includes 6 screws)	E-Gard	59 1/2"	11862743	
For frame height 74.000" – 79.999" (includes 6 screws)	E-Gard	65 1/2"	11862744	
For frame height 80.000" – 87.999" (includes 6 screws)	E-Gard	71 1/2"	11862745	
For frame height 88.000" – 102.000" (includes 6 screws)	E-Gard	79 1/2"	11862746	

Illustration <i>Not to Scale</i>	Description	Color	Part No.
	<b>Lock Base Assembly Kit</b> <i>Includes:</i> 1 – Lock base assembly 1 – #8-15 x 1" TEK-3, full thread, Phillips, pan head screw	---	11862718



**When ordering replacement aluminum parts specify:**

1. Order number/Line Number (if available)
2. Type of unit
3. Description
4. Color
5. Length

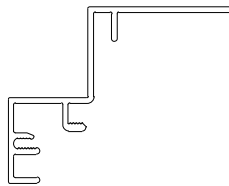

A3390, Interior Cover

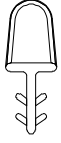
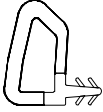
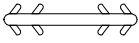
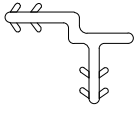
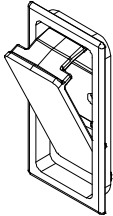
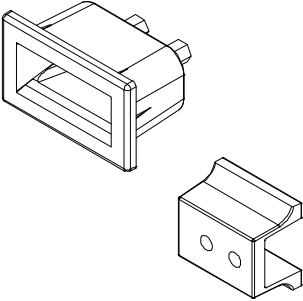
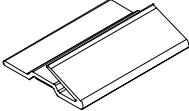
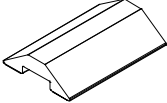
Illustration <i>Not to Scale</i>	Description	Length	Color	Part No.
	<b>Sash Weather strip</b> V2803	120" (5080)	Black	15816398
	<b>Frame Weather Strip</b> V2808	Specify Length	Black	15356397
	<b>Connecting Barb</b> V803	Specify Length	Beige	15812999
	<b>Connecting Barb</b> V087	6" (152)	Beige	16000602

Illustration <i>Not to Scale</i>	Description	Color	Part No.
	<b>Screen Latch Assembly Kit</b> <i>Includes:</i> 1 – Screen latch assembly 2 – Rivets		
		Ebony	11862481
		Bronze	11862482
		Stone White	11862483
		Gunmetal	11862484
	Silver	11862485	
	<b>Screen Latch Receiver Assembly Kit</b> <i>Includes:</i> 1 – Screen hardware latch receiver 1 – Screen hardware receiver back		
		Ebony	11862486
		Bronze	11862487
		Stone White	11862488
		Gunmetal	11862489
	Silver	11862490	
	<b>Screen Alignment Bumper</b>		
		Black	15709427
	<b>Screen Bottom Rail Bumper</b>		
		Gray	15709428