

WOOD AND CLAD ULTIMATE OUTSWING FRENCH DOOR

Table of Contents

	PAGE
History	2
Part Identification – Wood Ultimate Outswing French Door XX L	5
Part Identification – Wood Ultimate Outswing French Door OO	6
Part Identification – Wood Ultimate Outswing French Door In–Sash Transom	7
Part Identification – Wood Ultimate Outswing French Door 2, 3 and 4 Panel Jamb Detail	8
Part Identification – Wood Ultimate Outswing French Door Direct Glaze Transom	9
Part Identification – Clad Ultimate Outswing French Door XX L	10
Part Identification – Clad Ultimate Outswing French Door Stationary and Sidelite	11
Part Identification – Clad Ultimate Outswing French Door In–Sash Transom	12
Part Identification – Clad Ultimate Outswing French Door 2, 3 and 4 Panel Jamb Detail	13
Part Identification – Clad Ultimate Outswing French Door Direct Glaze Transom	14
Parts – Ultimate Outswing French Doors	15
Weather Strip and Vinyl	26
Replacement Wood Parts	29
Replacement Vinyl, Aluminum or Fiberglass Parts	30
Panel Replacement	31
Energy Panels and Parts	32
Obsolete Hardware Parts	33
Obsolete Wood Parts	46
Obsolete Vinyl, Aluminum and Fiberglass parts	48
Obsolete Replacement Panels	49
Obsolete Weather Strip	50
Discontinued Weather Strip	52
Obsolete Energy Panels and Parts	53

ATTENTION:

- Specification and technical data are subject to change without notice.
- Numbers listed in parentheses () are metric equivalents in millimeters rounded to the nearest whole number.

HISTORY

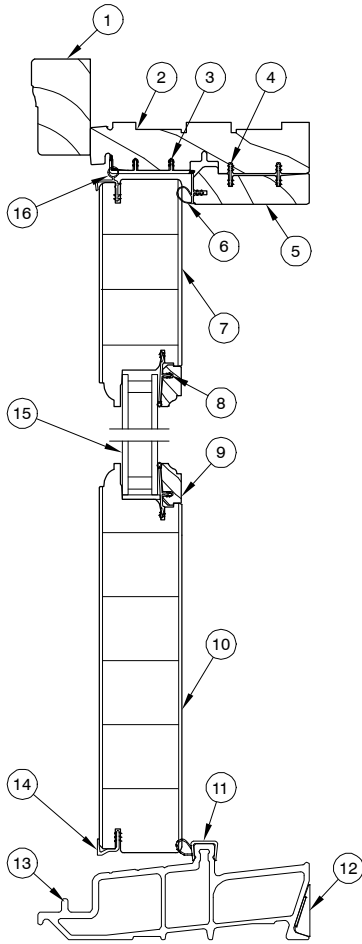
PRODUCED	UNIT TYPE	FEATURES OR CHANGES	DISCONTINUED
1989	Wood Outswing French Door	Unit features 3/4" insulating glass, 4 9/16" jambs, 2 of the hinges feature non-removable pins, no panel bore or lock (standard). Unit offered in CN 6-8, CN 7-0 and CN 8-0 heights. Unit featured solid brass head and foot bolts and optional solid brass lever set. Sidelites and transoms introduced.	2000
1990	Clad Outswing French Door	Unit features 3/4 insulating glass, 4 9/16" jambs, 2 of the hinges feature non-removable pins, no panel bore or lock (standard), solid brass head and foot bolts and extruded aluminum glazing cap system for 1 lite and ADL insulating glass. Unit offered in CN 6-8, CN 7-0 and CN 8-0 heights. Sidelites and transoms introduced. Brown Lexan sill.	2000 2000 1991
1991	Wood and Clad Outswing French Doors	CN 6-5 height introduced including a 4 panel entrance system with continuous head jamb and sill. External component parts changed from brown to beige. Lexan sill changed from brown to beige.	2000 1994
1991	Wood and Clad Outswing	Optional multi-point (Essve) hardware system introduced.	2000
1991	Wood Outswing French Door	Solid brass hinges introduced.	Present
1992	Wood Outswing French Doors	Simulated divided lite option introduced.	Present
1993	Clad Outswing French Doors	Factory applied brick mould casing and simulated divided lite option introduced.	Present
1994	Outswing French Doors	Beige Lexan sill changed to beige composite sill.	Present
1994	Wood Outswing French Door	Exterior factory finish available utilizing an interior glazed panel for 1 lite and ADL insulating glass.	1996
2000	Wood and Clad Outswing French Door, Transoms, sidelites Wood and Clad Ultimate Outswing French Door.	1/17/2000 New door line based on Inswing Door. Frame and sash components common when possible. Door rated to DP 20, DP 30 or DP 40 based on options and sizes selected. Transom sash in line with door sash below. Center mortise lock (center passage latch with independent dead bolt) replaces lever set with dead bolt utilizing Multi-point inswing FD handles. Multi-point (Amerock) lock available (std. Ultimate). Adjustable hinges standard. HP Package available on Clad Ultimate Outswing French Door. 8/4/2000 PVD brass hardware available on Ultimate Outswing French Door. Limited factory mulling options. Non-handed handle sets.	Present
2000	Wood and Clad Light Commercial Prep Door Introduced	1/17/2000 Unit uses common parts with outswing door. Jambs square cut at bottom to accept commercial or ADA sills. Ball bearing 4" butt hinges standard. 11 3/8" bottom rail standard. 8/4/2000 Brushed chrome ball bearing hinges available.	Present
2002	Wood and Clad Light Commercial Prep Door Introduced	3/02 Stone White becomes a standard color. Arctic White transitions to a select color. 8/0 height decreases by 2 1/2 inches.	Present
2003	Wood and Clad Outswing French Door	3/31/03 Satin Taupe (TP) hardware replaces brass as standard. Standard door now includes hardware (no lock, no bore is an option)	Present
2003	Wood and Clad Ultimate Outswing French Door	3/31/03 Satin Taupe (TP) hardware replaces brass as standard.	Present
2003	Wood and Clad Outswing Ultimate Outswing French Door	3/31/03 Strikes for Satin Taupe, Brushed Chrome, Polished Chrome and White are Stainless Steel.	Present
2004	Wood and Clad Outswing Ultimate Outswing French Door	1/04 Added Oiled Rubbed Bronze and Satin Chrome to available hardware finishes.	Present
2004	Wood and Clad Outswing French Door	4/12/04 Satin Nickel hardware finish introduced.	Present

HISTORY

PRODUCED	UNIT TYPE	FEATURES OR CHANGES	STATUS
2004	Wood and Clad Outswing French Door	6/14/04 Wood and Clad Direct Glaze transom redesigned. Polished chrome finish hardware is retired.	Present
2005	Wood and Clad Ultimate Outswing French Door	1/2005 New options: No lock. bore, bored mortise latch with deadbolt. Locking stiles use LVL core, optional bronze Ultrex sill with black weather strip. Options for Outswing French Door become available on Ultimate Outswing French Door. Outswing French Door now retired.	Present
2005	Wood/Clad Ultimate Outswing French Door	6/15/05 Changed jamb leaf on adjustable hinge to closed knuckle design.	Present
2005	Wood/Clad Ultimate Outswing French Door	6/27/05 Introduced Brass PVD and Satin Nickel PVD finishes to French door handles, adjustable hinges, and other miscellaneous parts.	Present
2006	Wood and Clad Outswing Ultimate Outswing French Door	7/24/06 Discontinued retro 6-5 height and replaced with 6-6 height. Frame OSM for 6-6 height is 3/4" taller than 6-5 doors. Frame OSM for 6-6 width is 11/16" wider (one panel), 1 3/8" wider (two panel) and 2 1/16" wider (three panel).	Present
2007	Wood and Clad Ultimate Outswing French Door	2/20/07 Introduced raised and flat panels as a standard option for Marvin French Doors and Commercial Doors.	Present
2008	Clad Ultimate Outswing French Door	7/28/2008 Mixed grain Douglas fir is now a standard option.	Present
2009	All	3/23/2009 Added LoE ³ -366™ as a standard option for all products. Added Cedro Macho as a standard option for all clad products.	Present
2010	All Doors	2/22/2010 Added Dark Bronze hardware finish for doors.	Present
2011	All Doors	4/25/2011 Added LoE-180™ as a standard option for all products. White painted interior finish option introduced for all products.	Present
2012	Wood and Clad Ultimate Outswing French Door	7/30/2012 Stave Core added to our description for current finger joint/edge glue construction of door panels. Redesign incorporating new cladding, frame and sill profile (F2050). Optional exterior sill cover available in Mahogany; Optional interior sill liner available in Oak, Mahogany, or Cherry. 10/29/2012 Interior Square Sticking/Glazing Bead option introduced. 12/17/2012 Introduced Clear Interior Finish option on all products.	Present
2013	Wood and Clad Ultimate Outswing French Door	4/29/2013 – Introduced Retro 2 Wide CNs on Full Size Heights. New CNs are 50R68, 50R70, 50R80, 60R68, 60R70, and 60R80. All Retro sizes, current and new, will be designated with an "R" in the CN. Introduced interior stain options. Stain colors are Wheat, Honey, Leather, Hazelnut, Cabernet and Espresso. 6/24/2013 – Direct Glaze Standardization added upgrades and improvements to direct glaze products in both wood and clad. Glazing method is silicone and interior tape glazed. Wood bead profile is W11751. 12/16/2013 – Interior Shades option introduced. Added SN PVD Butt Hinge option.	Present
2014	Wood and Clad Ultimate Outswing French Door	1/06/2014 – A new corner key design and weep process was implemented. See Product Bulletin 545 for more details. 2/24/2014 – Introduced two Pearlescent clad colors – Bright Silver and Copper. Discontinued two clad colors – Sherwood Green and Cobalt Blue. 4/28/2014 – Added the Contemporary Panel and Contemporary Handle options.	Present
2014	Wood and Clad Ultimate Outswing French Door	6/23/2014 – Added PVD color options for the Contemporary Handle; Oil Rubbed Bronze PVD and Satin Nickel PVD are now available.	Present
2014	Wood and Clad Ultimate Outswing French Door	10/27/2014 – Introduced Ogee as the new default interior profiles.	Present
2016	All	06/27/2016 – Introduced Matte Black as a standard hardware color. 10/31/2016 – Introduced 9-0 CN as a standard height. 10/31/2016 – Obsolescence of the wood species Cedro Macho for all products.	Present

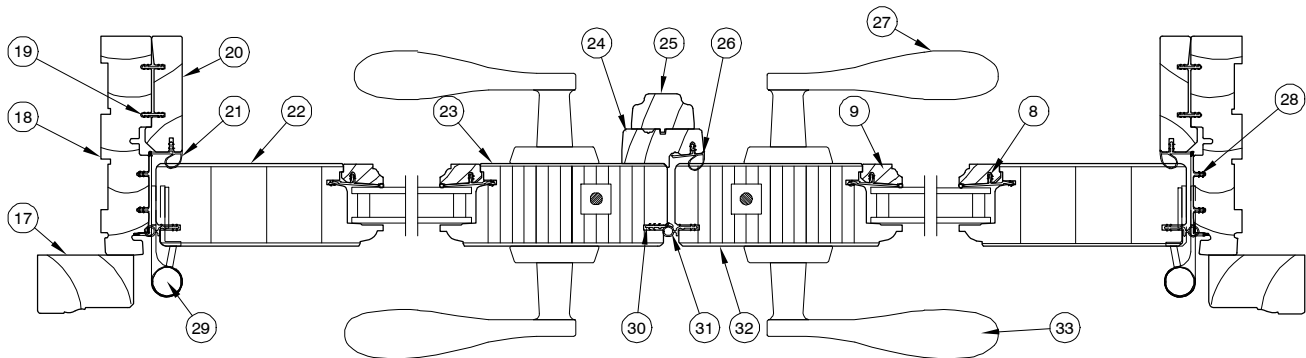
PRODUCED	UNIT TYPE	FEATURES OR CHANGES	STATUS
2017	All	10/30/2017 Discontinued Ep colors with exception of Stone White and Bronze	Present
2017	All	10/30/2017 – Discontinued Jamb align receiver and jamb align bracket.	Present

**WOOD ULTIMATE OUTSWING FRENCH DOOR
 XX R or L**



**Head Jamb
 and Sill**

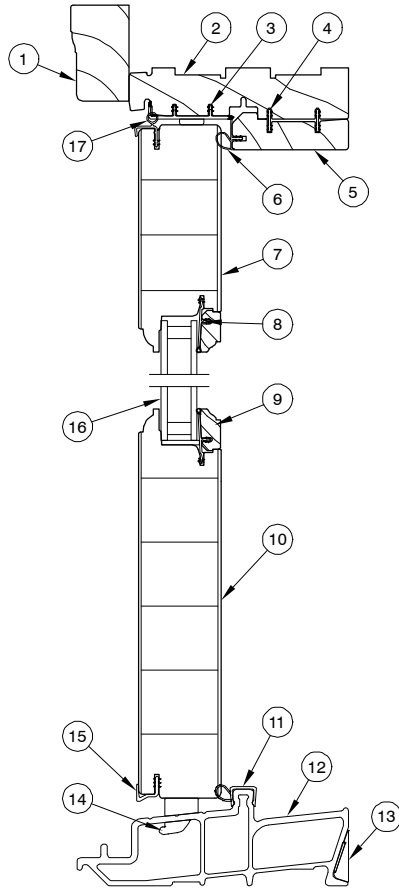
1. Head Jamb Brick Mould Casing
2. Head Jamb
3. Head Jamb Frame Vinyl (V2114)
4. Head Jamb Stop Connecting Barb
5. Head Jamb Part Stop
6. Head Jamb Part Stop Weather Strip
7. Top Rail
8. Glazing Bead
9. Glazing Cap
10. Bottom Rail
11. Sill Weather Strip
12. Sill Interior Filler Block
13. Sill, 4 9/16"
14. Panel Drip
15. Insulating Glass
16. Panel Cover Weather Strip
17. Jamb Brick Mould Casing
18. Jamb
19. Jamb Connecting Barb
20. Jamb Part Stop
21. Jamb Part Stop Weather Strip
22. Stile
23. Inactive Panel Locking Stile
24. Astragal Base
25. Astragal Cover
26. Astragal Weather Strip
27. Interior Handle Assembly
28. Jamb Frame Vinyl (V2114)
29. Adjustable Hinge
30. Inactive Stile Weather Strip
31. Stile Weather Strip
32. Active Panel Locking Stile
33. Exterior Handle Assembly



Jamb - XX L

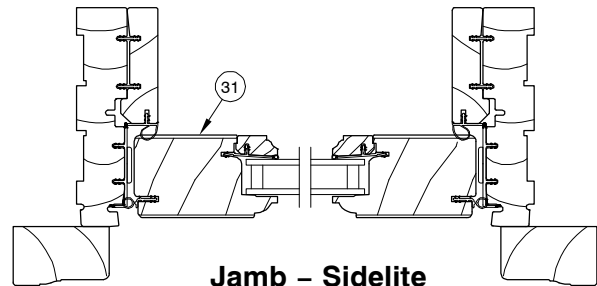
NOTE: Not to scale; specifications subject to change without notice.

**WOOD ULTIMATE OUTSWING FRENCH DOOR
 STATIONARY AND SIDELITE**

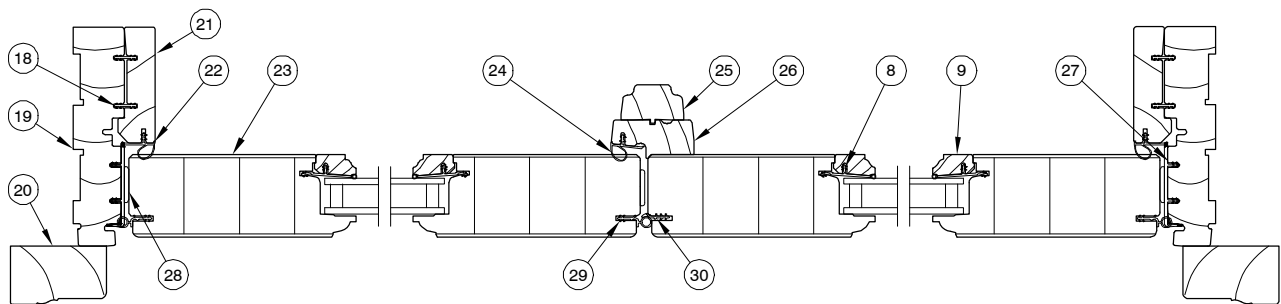


**Head Jamb
 and Sill**

1. Head Jamb Brick Mould Casing
2. Head Jamb
3. Head Jamb Frame Vinyl
4. Head Jamb Part Stop Connecting Barb
5. Head Jamb Part Stop
6. Head Jamb Part Stop Weather Strip
7. Top Rail
8. Glazing Bead
9. Glazing Cap
10. Bottom Rail
11. Sill Weather Strip
12. Sill, 4 9/16"
13. Sill Interior Filler Block
14. Stationary Panel Sill Bolt
15. Panel Drip
16. Insulating Glass
17. Panel Cover Weather Strip
18. Jamb Connecting Barb
19. Jamb
20. Jamb Brick Mould Casing
21. Jamb Part Stop
22. Jamb Part Stop Weather Strip
23. Stile
24. Astragal Weather Strip
25. Astragal Cover
26. Astragal Base
27. Jamb Frame Vinyl (V2114)
28. Spacer Tack
29. Stile Weather Strip
30. Inactive Stile Weather Strip
31. Narrow Sidelite Stile



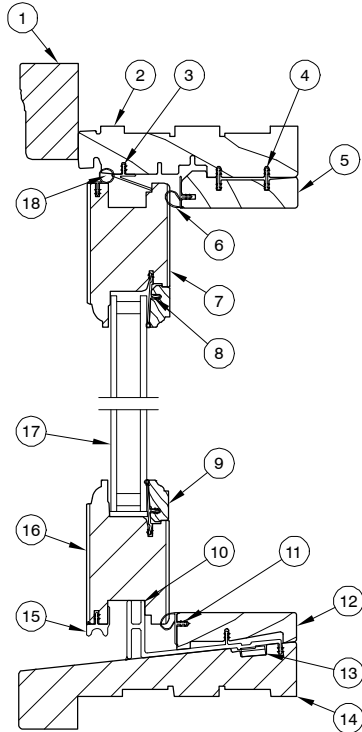
Jamb - Sidelite



Jamb - OO

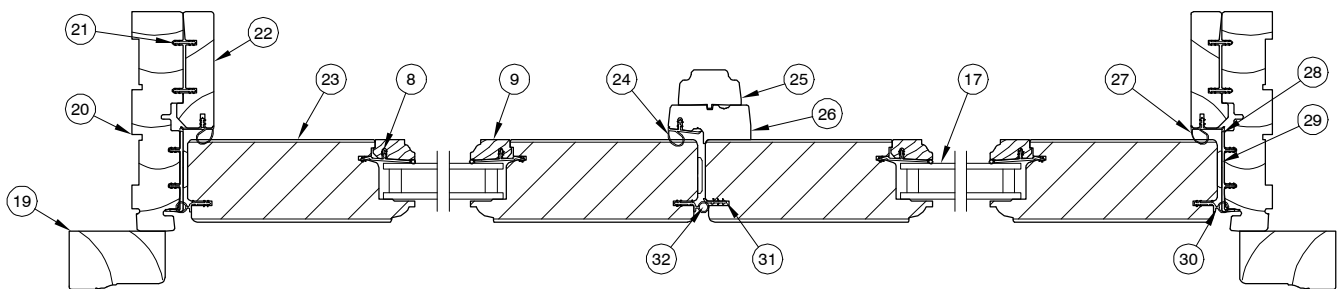
NOTE: Not to scale; specifications subject to change without notice.

**WOOD ULTIMATE OUTSWING FRENCH DOOR
 IN-SASH TRANSOM**



**Head Jamb
 and Sill**

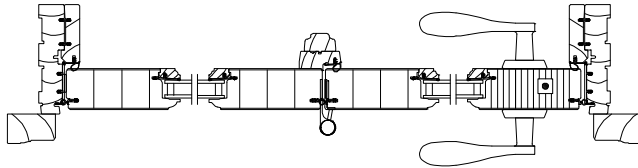
1. Head Jamb Brick Mould Casing
2. Head Jamb
3. Sash Retainer
4. Head Jamb Part Stop Connecting Barb
5. Head Jamb Part Stop
6. Head Jamb Part Stop Weather Strip
7. Top Rail
8. Glazing Bead
9. Glazing Cap
10. Sill Leveling Block
11. Sill Weather Strip
12. Sill Cover
13. Foam Tape
14. Sill
15. Panel Drip
16. Bottom Rail
17. Insulating Glass
18. Panel Weather Strip
19. Jamb Brick Mould Casing
20. Jamb
21. Jamb Connecting Barb
22. Jamb Part Stop
23. Stile
24. Astragal Weather Strip
25. Astragal Cover
26. Astragal Base
27. Jamb Part Stop Weather Strip (V2114)
28. Frame Weather Strip
29. Spacer Tack
30. Stile Weather Strip
31. Inactive Stile Weather Strip
32. Stile Weather Strip



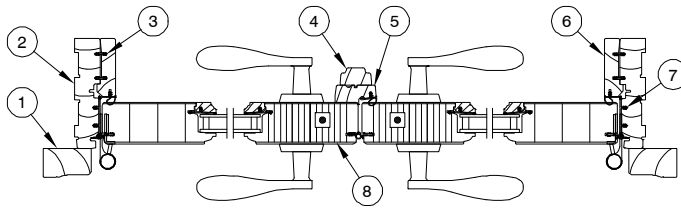
**Jamb - Transom OO
 (1 frame - 2 sash)**

NOTE: Not to scale; specifications subject to change without notice.

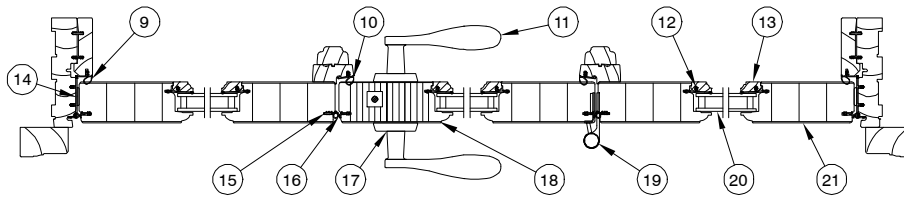
**WOOD ULTIMATE OUTSWING FRENCH DOOR
 JAMB DETAIL**



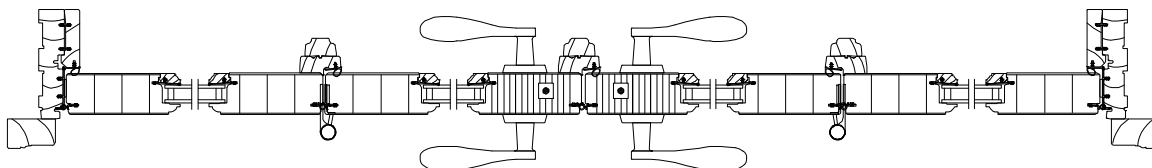
2 Panel Jamb - OX R



2 Panel Jamb - XX L



3 Panel Operating Jamb - OXO L

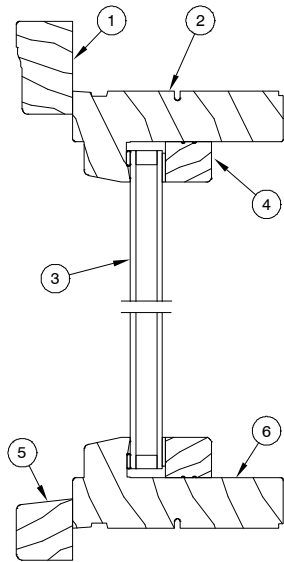


4 Panel Operating Jamb - OXXO L

1. Jamb Brick Mould Casing
2. Jamb
3. Jamb Part Stop Connecting Barb
4. Astragal Cover
5. Astragal Base
6. Jamb Part Stop
7. Jamb Frame Vinyl (V2114)
8. Inactive Panel Locking Stile
9. Jamb Part Stop Weather Strip
10. Astragal Weather Strip
11. Interior Handle Assembly
12. Glazing Bead
13. Glazing Cap
14. Spacer Tack
15. Inactive Stile Weather Strip
16. Stile Weather Strip
17. Exterior Handle Assembly
18. Active Panel Locking Stile
19. Adjustable Hinge
20. Insulating Glass
21. Stile

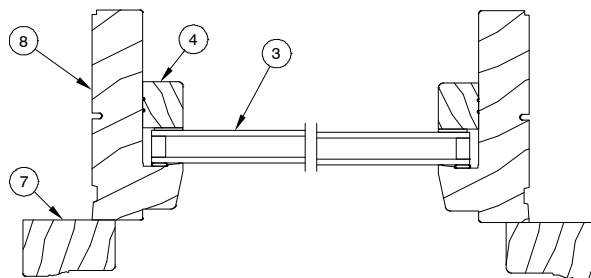
NOTE: Not to scale; specifications subject to change without notice.

**WOOD ULTIMATE OUTSWING
FRENCH DOOR DIRECT GLAZE TRANSOM**



- 1. Head Jamb Brick Mould Casing
- 2. Head Jamb
- 3. Insulating Glass
- 4. Glazing Bead (W11751)
- 5. Sill Nose, (W12059)
- 6. Sill
- 7. Jamb Brick Mould Casing
- 8. Side Jamb

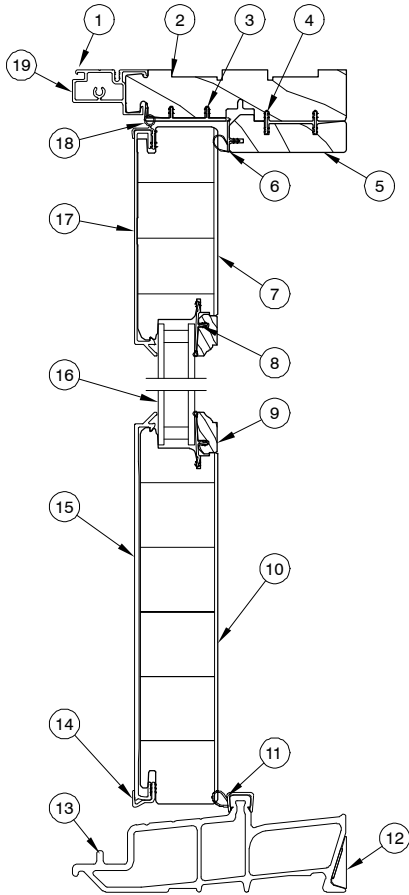
**Head Jamb
and Sill**



Jamb

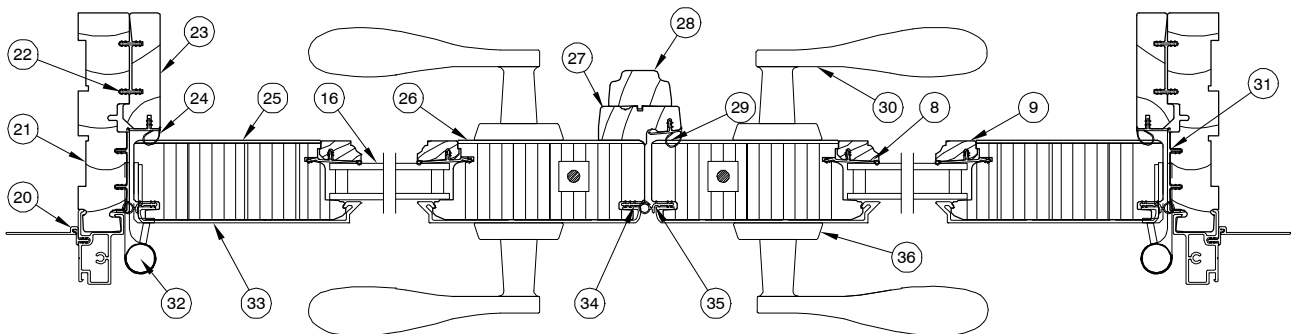
NOTE: Not to scale; specifications subject to change without notice.

**CLAD ULTIMATE OUTSWING FRENCH DOOR
 XX L or R**



1. Head Jamb Nail Fin/Drip Cap
2. Head Jamb
3. Head Jamb Vinyl (V2114)
4. Head Jamb Part Stop Connecting Barb
5. Head Jamb Part Stop
6. Head Jamb Part Stop Weather Strip
7. Top Rail
8. Glazing Bead
9. Glazing Cap
10. Bottom Rail
11. Sill Weather Strip
12. Sill Liner
13. Sill, 4 9/16"
14. Panel Drip
15. Bottom Rail Cladding
16. Insulating Glass
17. Top Rail Cladding
18. Panel Cover Weather Strip
19. Head Jamb Cladding
20. Jamb Nailing Fin
21. Jamb
22. Jamb Part Stop Connecting Barb
23. Jamb Part Stop
24. Jamb Part Stop Weather Strip
25. Stile
26. Inactive Panel Locking Stile
27. Astragal Base
28. Astragal Cover
29. Astragal Weather Strip
30. Interior Handle Assembly
31. Jamb Vinyl (V2114)
32. Adjustable Hinge
33. Stile Cladding
34. Inactive Weather Strip
35. Stile Weather Strip
36. Exterior Handle Assembly

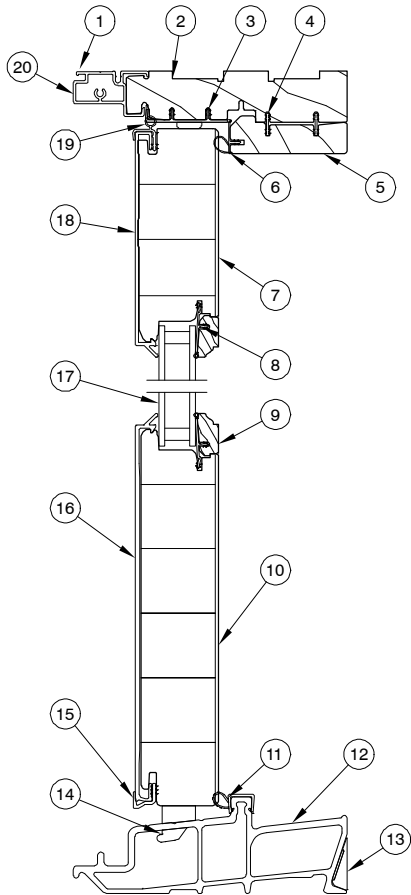
**Head Jamb
 and Sill**



Jamb - XX L

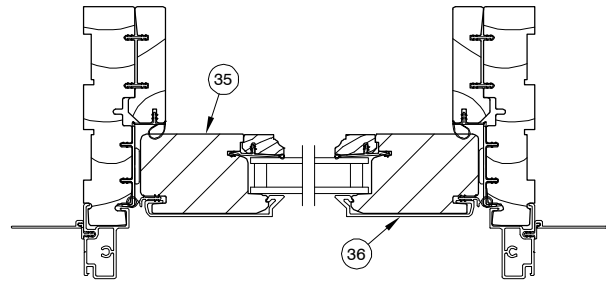
NOTE: Not to scale; specifications subject to change without notice.

**CLAD ULTIMATE OUTSWING FRENCH DOOR
 STATIONARY**

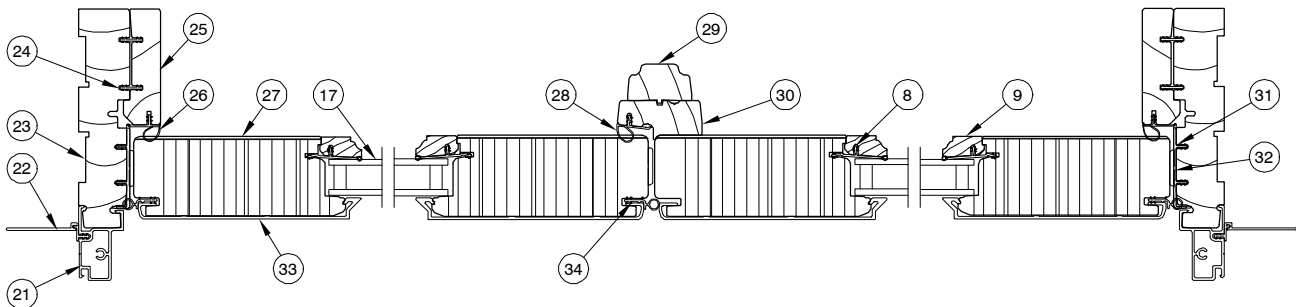


**Head Jamb
 and Sill**

1. Head Jamb Nail Fin/Drip Cap
2. Head Jamb
3. Head Jamb Vinyl (V2114)
4. Head Jamb Part Stop Connecting Barb
5. Head Jamb Part Stop
6. Head Jamb Part Stop Weather Strip
7. Top Rail
8. Glazing Bead
9. Glazing Cap
10. Bottom Rail
11. Sill Weather Strip
12. Sill, 4 9/16"
13. Sill Interior Filler
14. Stationary Sill Bolt
15. Panel Drip
16. Bottom Rail Cladding
17. Insulating Glass
18. Top Rail Cladding
19. Panel Cover Weather Strip
20. Head Jamb Cladding
21. Jamb Cladding
22. Jamb Nailing Fin
23. Jamb
24. Jamb Part Stop Connecting Barb
25. Jamb Part Stop
26. Jamb Part Stop Weather Strip
27. Stile
28. Astragal Weather Strip
29. Astragal Cover
30. Astragal Base
31. Jamb Weather Strip
32. Spacer Tack
33. Stile Cladding
34. Stile Weather Strip
35. Narrow Sidelite Stile
36. Narrow Sidelite Stile Cladding



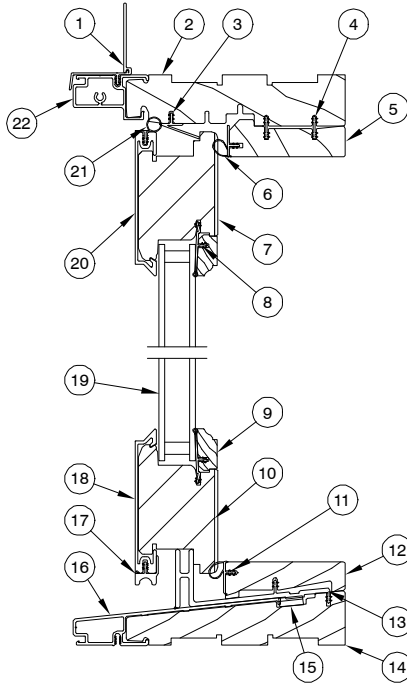
Sidelite



Jamb - OO

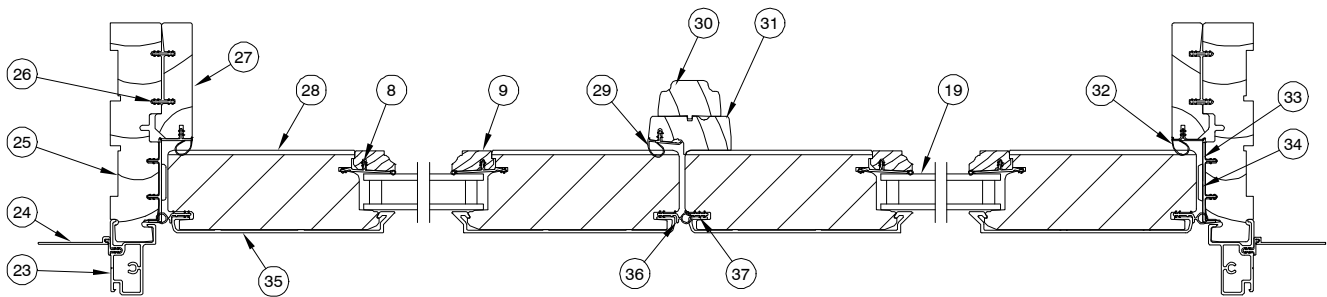
NOTE: Not to scale; specifications subject to change without notice.

**CLAD ULTIMATE OUTSWING FRENCH DOOR
 IN-SASH TRANSOM**



**Head Jamb
 and Sill**

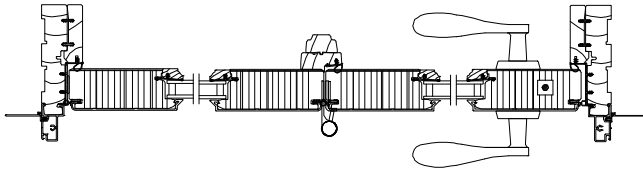
1. Head Jamb Nail Fin/Drip Cap
2. Head Jamb
3. Sash Retainer
4. Head Jamb Stop Connecting Barb
5. Head Jamb Stop
6. Head Jamb Stop Weather Strip
7. Top Rail
8. Glazing Bead
9. Glazing Cap
10. Bottom Rail
11. Sill Cover Weather Strip
12. Sill Cover
13. Sill Leveling Block
14. Sill
15. Foam Tape
16. Sill Cladding
17. Panel Drip
18. Bottom Rail Cladding
19. Insulating Glass
20. Top Rail Cladding
21. Top Rail Weather Strip
22. Head Jamb Cladding
23. Jamb Cladding
24. Jamb Nailing Fin
25. Jamb
26. Jamb Connecting Barb
27. Jamb Stop
28. Stile
29. Astragal Weather Strip
30. Astragal Cover
31. Astragal Base
32. Jamb Stop Weather Strip
33. Jamb Weather Strip
34. Spacer Tack
35. Stile Cladding
36. Stile Weather Strip
37. Inactive Stile Weather Strip



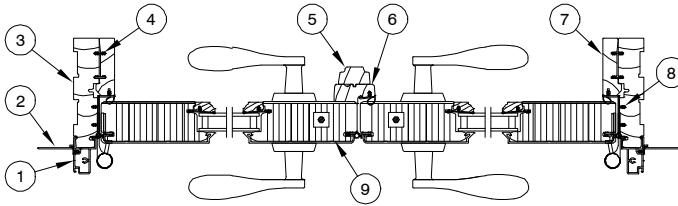
**Jamb - Transom - OO
 (1 frame - 2 sash)**

NOTE: Not to scale; specifications subject to change without notice.

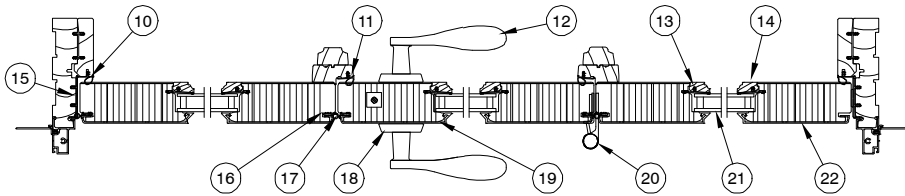
**CLAD ULTIMATE OUTSWING FRENCH DOOR
 JAMB DETAIL**



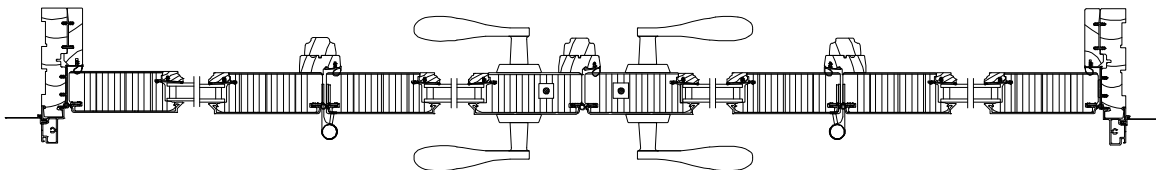
2 Panel Jamb – OX R



2 Panel Jamb – XX L



3 Panel Operating Jamb – OXO L

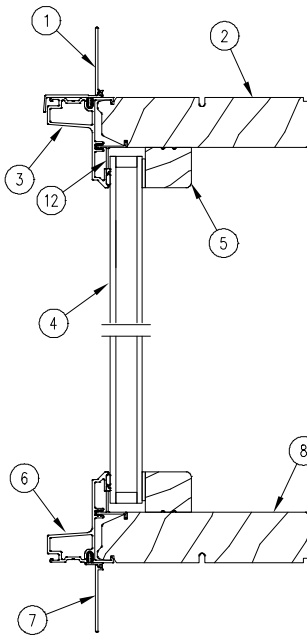


4 Panel Operating Jamb – OXXO L

1. Jamb Cladding
2. Jamb Nailing Fin
3. Jamb
4. Jamb Stop Connecting Barb
5. Astragal Cover
6. Astragal Base
7. Jamb Stop
8. Jamb Weather Strip
9. Inactive Panel Locking Stile
10. Jamb Stop Weather Strip
11. Astragal Weather Strip
12. Interior Handle Assembly
13. Glazing Bead
14. Glazing Cap
15. Spacer Tack
16. Inactive Stile Weather Strip
17. Stile Weather Strip
18. Exterior Handle Assembly
19. Active Panel Locking Stile
20. Adjustable Hinge
21. Insulating Glass
22. Stile

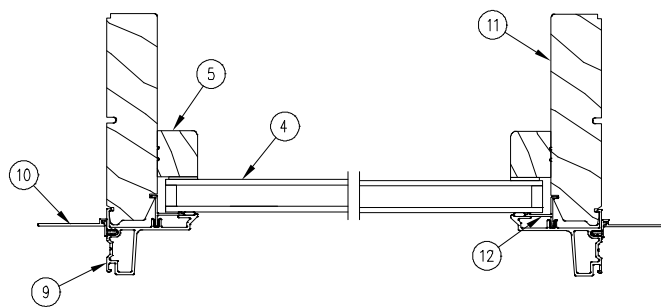
NOTE: Not to scale; specifications subject to change without notice.

**CLAD ULTIMATE OUTSWING FRENCH DOOR
DIRECT GLAZE TRANSOM**



1. Head Jamb Nailing Fin/Drip Cap
2. Head Jamb
3. Head Jamb Cladding
4. Insulated Glass
5. Glazing Bead (W11751)
6. Sill Cladding
7. Sill Nailing Fin
8. Sill
9. Jamb Cladding
10. Jamb Nailing Fin
11. Jamb
12. Attachment Barb

**Head Jamb
and Sill**



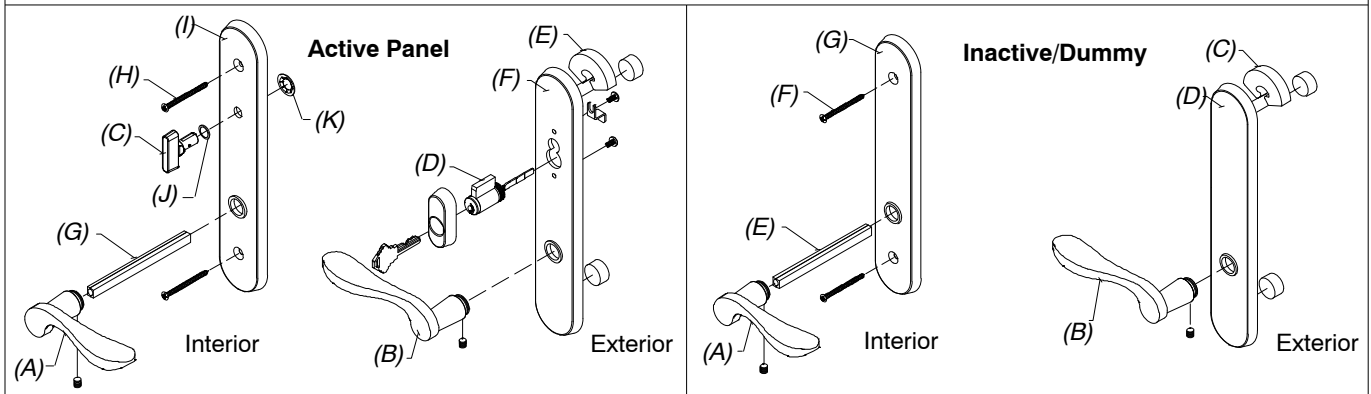
Jamb Detail

NOTE: Not to scale; specifications subject to change without notice.


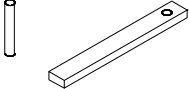

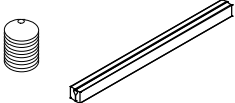
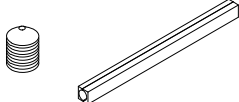
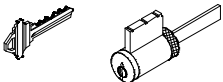
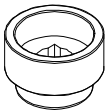
When ordering replacement parts specify:

1. type of unit;
2. part number;
3. description.

ILLUSTRATIONS (not to scale)


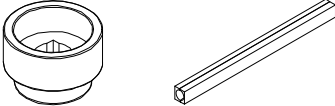


<p>Handle Assembly, Active Panel Mortise lock and Multi-point lock systems (Schlage "C" keyway) Includes: 1 - Interior lever (A) with 00142006 spindle, escutcheon plate and hardware 1 - Exterior lever (B) with escutcheon plate and hardware 1 - Thumb turn (C) with hardware 1 - Keyed cylinder (D) with housing and hardware 1 - Exterior escutcheon plate gasket (E) 1 - Exterior escutcheon plate (F) 1 - Two piece spindle (G) 2 - #10-32 x 2 1/8" Phillips ovalhead machine screws (H) 1 - Interior escutcheon plate (I) 1 - Thumb turn washer (J) 1 - Thumb turn push nut (K) 2 - Keys</p>	<p>Satin Taupe Antique Brass White Satin Chrome Oil Rubbed Bronze ORBZ PVD Brass PVD Satin Nickel PVD Dark Bronze Polished Chrome Matte Black</p>	<p>10830304 10830306 10830310 10830302 10148111 10830300 10830324 10830421 10830330 10830308 10830450</p>
<p>Handle Assembly, Inactive/Dummy Includes: 1 - Interior lever (A) with 00142006 spindle, escutcheon plate and hardware 1 - Exterior lever (B) with escutcheon plate and hardware 1 - Exterior escutcheon plate gasket (C) 1 - Exterior escutcheon plate (D) 1 - Two piece spindle (E) 2 - #10-32 x 2 1/8" Phillips ovalhead machine screws (F) 1 - Interior escutcheon plate (G)</p>	<p>Satin Taupe Antique Brass White Satin Chrome Oil Rubbed Bronze ORBZ PVD Brass PVD Satin Nickel PVD Dark Bronze Polished Chrome Matte Black</p>	<p>10830318 10830312 10830316 10830320 10148154 10830322 10830326 10830422 10830328 10830314 10148157</p>
<p>Thumb Turn (C) NOTE: For each thumb turn, order one thumb turn washer -00143045 (J) and one thumb turn push nut 00143010 (K).</p>	<p>Satin Taupe Antique Brass White Oil Rubbed Bronze Brass PVD Satin Nickel PVD Satin Chrome Dark Bronze Oil Rubbed Bronze PVD Matte Black</p>	<p>00142061 00142055 00142058 00142062 00142054 00142063 00142064 10148426 10148428 10148480</p>

ILLUSTRATION NOT TO SCALE	DESCRIPTION	OPER./COLOR	PART NO.
	Lug seals		00142046
	Actuator with Rol-Pin <i>9/25/00 – Present</i>		05570548
	#10–32 x 2 1/8" Phillips ovalhead machine screws	Satin Taupe Antique Brass White Satin Chrome Oil Rubbed Bronze ORBZ PVD Brass PVD Satin Nickel PVD Dark Bronze Matte Black	11800616 00143038 00143036 10840031 10840032 11800160 11800615 11801020 11800654 11800181
	Spindle Kit (Truth & Ashland) <i>Includes:</i> 1 – 2 piece. spindle, 4 3/8" 2 – Set screws		02100942
	Spindle Kit (HOPPE) <i>Includes:</i> 1 – 2 piece. spindle, 4 3/4" 2 – Set screws		10148414
	Key Cylinder, Lock (Schlage "C" keyway) For service replacement only.	Brass Face Chrome Face	10830211 10830208
	3/4" Handle Extension Requires 3/4" Spindle Extension	TP WH BS PVD AB ORBZ ORBZ PVD SC SN PVD PC DK BZ MBK	10830048 10833063 10833058 10833057 10833038 10833059 10833056 10148422 10833062 10833054 10833055
	3/8" Handle Extension Requires 3/8" Spindle Extension	TP WH BS PVD AB ORBZ ORBZ PVD SC SN PVD PC DK BZ MBK	10833049 10830055 N/A 10833046 10833044 10833048 10833045 10830039 N/A 10833042 10833043

NOTE: Dark Bronze screws are used with Antique Brass and Oil Rubbed Bronze PVD

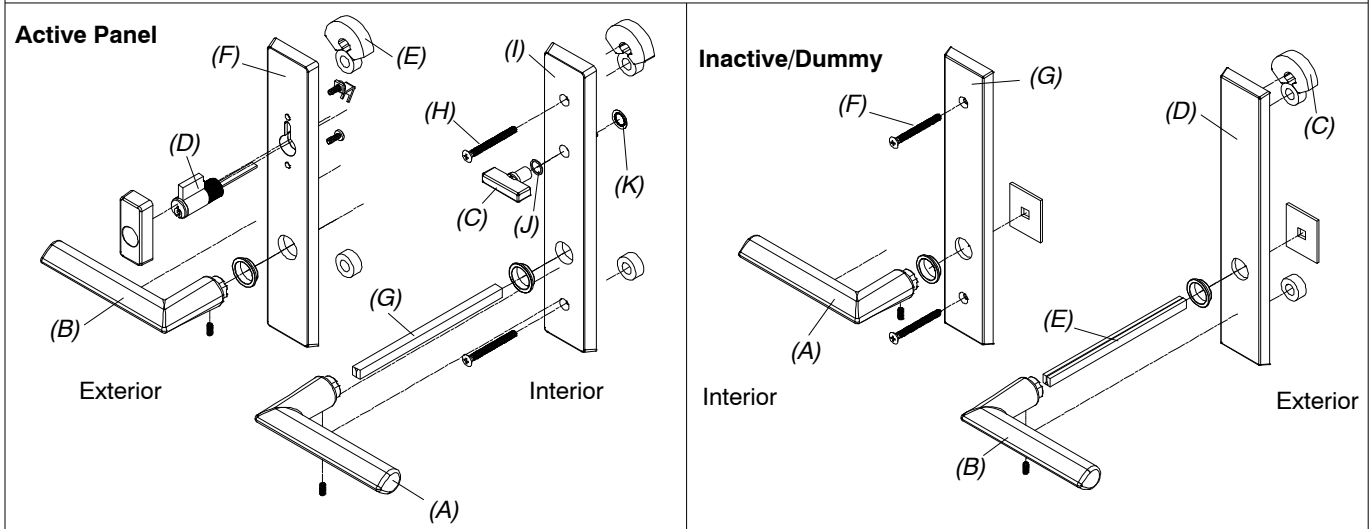
PARTS – TRADITIONAL HANDLE

ILLUSTRATION <i>NOT TO SCALE</i>	DESCRIPTION	LENGTH./COLOR	PART NO.
	3/4" Spindle Extension 3/8" Spindle Extension	5 13/16" 5 1/16"	00142051 18900393
	1 3/4" Swinging Handle Set Kit – Interior Shades <i>Includes:</i> 1 – 3/4" extension handle 1 – Spindle, lever handle, 2 pc. assembly 1 – Installation instruction	TP WH BS PVD AB ORBZ ORBZ PVD SC SN PVD PC DK BZ MBK	18900650 18900651 18900652 18900653 18900654 18900655 18900656 18900657 18900669 18900658 18900688

When ordering replacement parts specify:

1. type of unit;
2. part number;
3. description.

ILLUSTRATIONS (not to scale)



<p>Handle Assembly, Active Panel Mortise lock and Multi-point lock systems (Schlage "C" keyway) Includes: 1 – Interior lever (A) with 10148414 spindle, escutcheon plate and hardware 1 – Exterior lever (B) with escutcheon plate and hardware 1 – Thumb turn (C) with hardware 1 – Keyed cylinder (D) with housing and hardware 1 – Exterior escutcheon plate gasket (E) 1 – Exterior escutcheon plate (F) 1 – Two piece spindle (G) 2 – M5 x 55mm Phillips ovalhead machine screws (H) 1 – Interior escutcheon plate (I) 1 – Thumb turn washer (J) 1 – Thumb turn push nut (K) 2 – Keys</p>	<p>ORBZ PVD SN PVD DK BZ MBK</p>	<p>11102151 11102152 11102156 11102192</p>
<p>Handle Assembly, Inactive/Dummy Includes: 1 – Interior lever (A) with 00142006 spindle, escutcheon plate and hardware 1 – Exterior lever (B) with escutcheon plate and hardware 1 – Exterior escutcheon plate gasket (C) 1 – Exterior escutcheon plate (D) 1 – Two piece spindle (E) 2 – M5 x 55mm Phillips ovalhead machine screws (F) 1 – Interior escutcheon plate (G)</p>	<p>ORBZ PVD SN PVD DK BZ MBK</p>	<p>11102154 11102155 11102157 11102193</p>
<p>Thumb Turn (C) NOTE: For each thumb turn, order one thumb turn washer –10148423(J) and one thumb turn push nut 10148424(K).</p>	<p>ORBZ PVD SN PVD DK BZ</p>	<p>10148428 10148427 10148426</p>

PARTS – CONTEMPORARY HANDLE


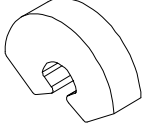

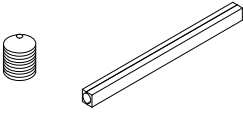

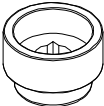

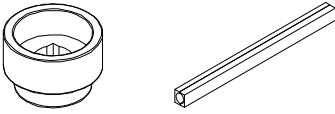
ILLUSTRATION NOT TO SCALE	DESCRIPTION	OPER./COLOR	PART NO.
	Gasket Post		10148404
	Gasket – Top Backplate		10148405
	M5 x 55mm Phillips ovalhead machine screw	TP ORBZ PVD SN PVD DK BZ MBK	10148400 10148402 10148403 10148401 10148440
	Spindle Kit (HOPPE) <i>Includes:</i> 1 – 2 piece. spindle, 4 3/4" 2 – Set screws		10148414
	Key Cylinder, Lock (Schlage “C” keyway) For service replacement only. BS, ORBZ PVD, TP, WH, AB=Brass Face All other Marvin finishes=Chrome Face	Brass Face Chrome Face	10830211 10830208
	3/4" Handle Extension Requires 3/4" Spindle Extension	TP ORBZ PVD SN PVD DK BZ	10148419 10148421 10148422 10148420
	3/4" Spindle Extension (HOPPE)		10148415
	1 3/4" Swinging Handle Set Kit – Interior Shades <i>Includes:</i> 1 – 3/4" extension handle 1 – Spindle, lever handle, 2 pc. assembly 1 – Installation instruction	TP ORBZ PVD SN PVD DK BZ	21448100 21448102 21448103 21448101

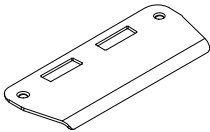
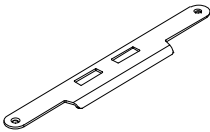
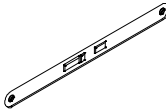
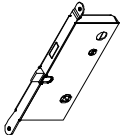
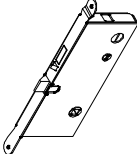
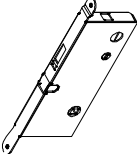
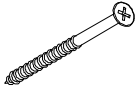
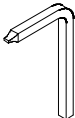
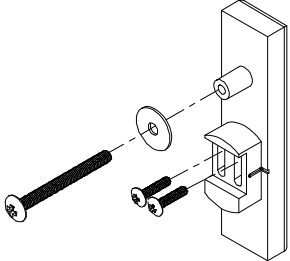
ILLUSTRATION NOT TO SCALE	DESCRIPTION	OPER./COLOR	PART NO.
	<p>Strike Plate, Jamb – Mortise Lock or Multi-Point Lock* 1/17/00 – Present (Amerock) Includes: 1 – Jamb strike plate 2 – #8x1" Brass Phillips flathead wood screws</p>	<p>Stainless Steel Antique Brass ORBZ PVD Brass PVD</p>	<p>05700016 05700012 05700118 10148175</p>
	<p>Strike Plate, Panel – Mortise Lock or Multi-Point Lock* 1/17/00 – Present (Amerock) Includes: 1 – Jamb strike plate 2 – #8x1" Brass Phillips flathead wood screws</p>	<p>Stainless Steel Antique Brass ORBZ PVD Brass PVD</p>	<p>05700049 05700044 05700117 10148176</p>
	<p>Cover Plate, Active Panel – Mortise Lock or Multi-Point Lock* 1/17/00 – Present (Amerock) Includes: 1 – Cover plate 2 – #8x1" Phillips flathead wood screws</p>	<p>Stainless Steel Antique Brass ORBZ PVD Brass PVD</p>	<p>05700107 05700102 05700128 10148172</p>
	<p>Mortise Lock, Active Single-Point Lock (latch, dead bolt only) 1/17/00 – Present (Amerock)</p>		<p>05700129</p>
	<p>Mortise Lock, Active Multi-Point Lock (latch, dead bolt and head/foot shoot bolts) 1/17/00 – Present (Amerock)</p>		<p>05700130</p>
	<p>Mortise Lock, Inactive Multi-Point Lock (head/foot shoot bolts) 1/17/00 – Present (Amerock)</p>		<p>05700131</p>
	<p>Long Hinge Screw Package OFD – std. UOFD – std. Includes: 4 – #10 X 2 1/2" Screws 1 – 5/32" Allen wrench NOTE: Order DK BZ screw package for DK BZ, AB and ORBZ Hinges. Order SS screw package for SF, SC and SN PVD Hinges .</p>	<p>TP GT DK BZ WH SS BS PVD MBK</p>	<p>11800653 11800632 11800644 11800637 11800639 10148185 11800696</p>
	<p>Construction Handle</p>		<p>05700133</p>
	<p>Construction Lock Assembly For Marvin residential swinging and sliding doors with standard locks. Includes: 1 – Construction Lock Cover 1 – Construction Lock Hole Cover 1 – Washer 2 – #6-32 X 5/8" Phillips TH screws 1 – #10-32 X 2" Phillips TH screw</p>	<p>Each 25/Box</p>	<p>18450200 18450198</p>

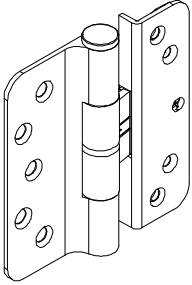
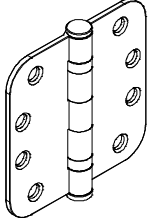
ILLUSTRATION NOT TO SCALE	DESCRIPTION	HINGE COLOR	LEFT PART NO.	RIGHT PART NO.
	<p>Hinge Kit, Adjustable Includes: 1 - Adjustable hinge 1 - #10x2 1/2" Phillips flathead wood screws (jamb) 5 - #10x3/4" Phillips flathead wood screws (jamb, stationary stile) 4 - #8x1 1/2" Phillips flathead wood screws (panel)</p> <p>NOTE: Hinge part number includes the color matched screws. If you need to order the screws separately, they are listed below.</p>	TP GT SF DKBZ AB WH SC ORBZ ORBZ PVD BS PVD SN PVD PC MBK	02101216 02101213 02101218 02101217 02101210 02101214 02101212 02101219 02101211 02101215 02101220 02101234 02101236	02101227 02101224 02101229 02101228 02101221 02101225 02101223 02101230 02101222 02101226 02101231 02101235 02101237
SCREW DESCRIPTION	SCREW COLOR/PART NO.	MATCHING HINGE COLOR		
#8x1 1/2" Phillips flathead wood screws (panel). Quantity of four needed per hinge.	TP 11865177 GT 11865172 WH 11865173 DKBZ 02058013 BS PVD 11865176 SS 11865175 MBK 11865178	TP GT WH AB, ORBZ PVD, DKBZ, ORBZ BS PVD SC, SF, SN PVD, PC MBK		
#10x 3/4" Phillips flathead wood screws (jamb) (stationary stile). Quantity of five needed per hinge.	TP 11800674 GT 11800670 WH 11800671 DKBZ 11800669 BS PVD 11800673 CHROME 11800672 MBK 11800677	TP GT WH AB, ORBZ PVD, DKBZ, ORBZ BS PVD SC, SF, SN PVD, PC MBK		
#10x2 1/2" Phillips flathead wood screws (jamb). Quantity of one needed per hinge.	TP 11800683 GT 11800681 WH 11800682 DKBZ 11800680 BS PVD 11800679 SS 11800684 MBK 11800693	TP GT WH AB, ORBZ PVD, DKBZ, ORBZ BS PVD SC, SF, SN PVD, PC MBK		
	<p>Ball Bearing Hinge 4" x 4"</p>	BS SC BZ	02100470 02100471 02100472	

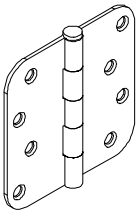
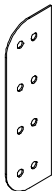
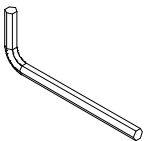

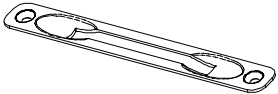
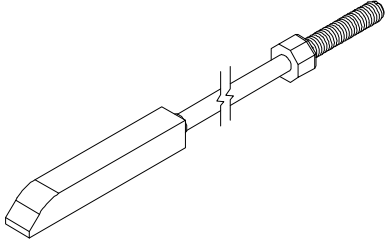
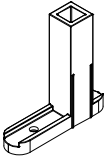
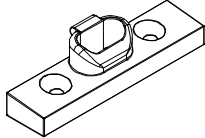
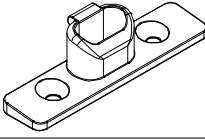
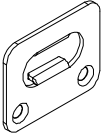
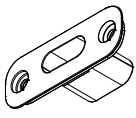
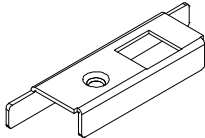

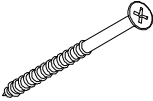
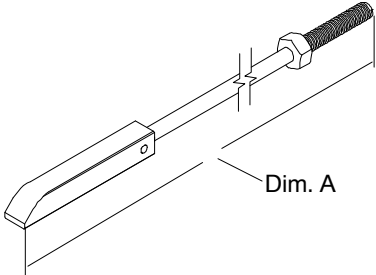
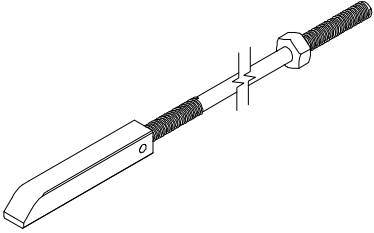
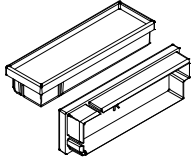
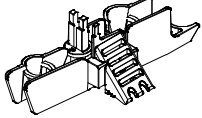
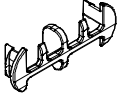
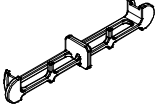


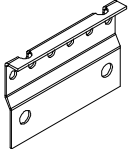
ILLUSTRATION NOT TO SCALE	DESCRIPTION	OPER./COLOR	PART NO.
	<p>4" Butt Hinge NRP = Non Removable Pin Includes: 1 - 4" Hinge 7 - #9 x 1" Phillips flathead wood screws (11213824) 1 - #10 x 2 1/2" Phillips flathead wood screws (frame) (11800679)</p>	<p>BS SN PVD SS</p>	<p>02101140 02100599 11809005</p>
	<p>4" Butt Hinge Shim</p>		<p>10500222</p>
	<p>5/32" Hex Key Adjustable Hinges</p>	<p>Black Steel</p>	<p>02069592</p>
	<p>Head or Foot Flush Bolt – Inactive Panel</p>	<p>Black</p>	<p>11101780</p>
	<p>Cover Plate for Flush Bolt Includes: 1 - Cover plate 2 - #8 x 1" Stainless Steel Screw (11800645)</p>	<p>Aluminum</p>	<p>11860402</p>

ILLUSTRATION NOT TO SCALE	DESCRIPTION	OPER./COLOR	PART NO.																
	<p>Inactive Panel Locking Rod Assembly, Top or Bottom Flush Bolt (XX configuration) 1/17/00 – Present Includes: 1 – Locking rod with end bolt</p> <p>NOTE: For 8-0 ht order top locking rod 05700185.</p> <table border="0"> <tr> <td>Height</td> <td>Top Locking Rod Length</td> </tr> <tr> <td>CN 6-6R ht*</td> <td>11"</td> </tr> <tr> <td>CN 6-8 ht</td> <td>11"</td> </tr> <tr> <td>CN 7-0 ht</td> <td>11"</td> </tr> <tr> <td>CN 8-0 ht</td> <td>27"</td> </tr> <tr> <td>CN 9-0 ht</td> <td>34 1/4"</td> </tr> </table> <table border="0"> <tr> <td>Height</td> <td>Bottom Locking Rod Length</td> </tr> <tr> <td>All heights</td> <td>11"</td> </tr> </table>	Height	Top Locking Rod Length	CN 6-6R ht*	11"	CN 6-8 ht	11"	CN 7-0 ht	11"	CN 8-0 ht	27"	CN 9-0 ht	34 1/4"	Height	Bottom Locking Rod Length	All heights	11"	<p>Stainless Steel</p> <p>Stainless Steel</p>	<p>05700180 05700180 05700180 05700185 05700170</p> <p>10815178</p>
Height	Top Locking Rod Length																		
CN 6-6R ht*	11"																		
CN 6-8 ht	11"																		
CN 7-0 ht	11"																		
CN 8-0 ht	27"																		
CN 9-0 ht	34 1/4"																		
Height	Bottom Locking Rod Length																		
All heights	11"																		
	<p>End Bolt Guide Active Panels – w/Multi-Point Inactive Panels – All</p> <p>Includes: 1 – End Bolt guide 1 – #8x1 1/2" Phillips panhead wood screw (11865159)</p>		<p>10815199</p>																
	<p>Sill Bolt, Stationary Outswing</p> <p>Includes:</p>	<p>Zinc Die Cast</p>	<p>11869822</p>																
	<p>Sill Bolt, Center, Stationary</p> <p>Includes:</p>	<p>Zinc Die Cast</p>	<p>11869821</p>																
	<p>Strike, Sill</p> <p>Includes:</p>	<p>SS</p>	<p>10148080</p>																
	<p>Strike Plate, Head Jamb</p> <p>Includes: 2 – #8 x 5/8" Phillips trusshead stainless steel machine screws (head jamb)(11800815) 2 – #8 x 3" trusshead SS screw</p>	<p>BG BZ</p>	<p>05700315 05700316</p>																
	<p>Stile End Plate</p> <p>Includes:</p>	<p>SS</p>	<p>10148008 (LH) 10148007 (RH)</p>																

* Can be used for obsolete 6-5 height.

ILLUSTRATION NOT TO SCALE	DESCRIPTION	OPER./COLOR	PART NO.												
	Well-Nut Sill Strike	Black	10830008												
	Installation Screw Package; Strike Plate(s) at head jamb, or locking jamb #8 x 2 1/2" Flathead wood screw Package of 4 Package of 4 Package of 4	Stainless Steel Brass PVD Antique Brass	11882349 11882343 11882347												
 <p style="text-align: right;">Dim. A</p>	Locking Rod Assembly, Top – Multi-Point Lock <i>3/02- Present (Amerock) 8-0 Height see History</i> <i>5/10/90 - Present (Amerock) 6-5, 6-8, & 7-0 Height</i> Solid stainless steel rod with 1/4" – 20 threads NOTE: For special heights give dimension A. <table border="0"> <thead> <tr> <th>Height</th> <th>Top Locking Rod Length</th> </tr> </thead> <tbody> <tr> <td>CN 6-6R ht</td> <td>35 7/16"</td> </tr> <tr> <td>CN 6-8 ht</td> <td>37 15/16"</td> </tr> <tr> <td>CN 7-0 ht</td> <td>41 15/16"</td> </tr> <tr> <td>CN 8-0 ht</td> <td>51 7/16"</td> </tr> <tr> <td>CN 9-0 ht</td> <td>63 7/16"</td> </tr> </tbody> </table>	Height	Top Locking Rod Length	CN 6-6R ht	35 7/16"	CN 6-8 ht	37 15/16"	CN 7-0 ht	41 15/16"	CN 8-0 ht	51 7/16"	CN 9-0 ht	63 7/16"	Stainless Steel	05700174 05700176 05700177 05700179 05700191
Height	Top Locking Rod Length														
CN 6-6R ht	35 7/16"														
CN 6-8 ht	37 15/16"														
CN 7-0 ht	41 15/16"														
CN 8-0 ht	51 7/16"														
CN 9-0 ht	63 7/16"														
	Locking Rod Assembly, Bottom for Multi-Point Lock Solid stainless steel rod with 1/4" – 20 threads <table border="0"> <thead> <tr> <th>Height</th> <th>Bottom Locking Rod Length</th> </tr> </thead> <tbody> <tr> <td>CN 6-6R ht*</td> <td>34 9/32"</td> </tr> <tr> <td>CN 6-8 ht</td> <td>34 9/32"</td> </tr> <tr> <td>CN 7-0 ht</td> <td>34 9/32"</td> </tr> <tr> <td>CN 8-0 ht</td> <td>34 9/32"</td> </tr> <tr> <td>CN 9-0 ht</td> <td>34 9/32"</td> </tr> </tbody> </table>	Height	Bottom Locking Rod Length	CN 6-6R ht*	34 9/32"	CN 6-8 ht	34 9/32"	CN 7-0 ht	34 9/32"	CN 8-0 ht	34 9/32"	CN 9-0 ht	34 9/32"	Stainless Steel	05700170
Height	Bottom Locking Rod Length														
CN 6-6R ht*	34 9/32"														
CN 6-8 ht	34 9/32"														
CN 7-0 ht	34 9/32"														
CN 8-0 ht	34 9/32"														
CN 9-0 ht	34 9/32"														







* Can be used for obsolete 6-5 height.

ILLUSTRATION NOT TO SCALE	DESCRIPTION	OPER./COLOR	PART NO.
 <p>RH Shown</p>	End Plug, Flat Casing	LH BG RH BG LH BZ RH BZ	11869852 11869850 11869853 11869851
	Pre 2014 Sill End Plug	LH BK RH BK	11869836 11869837
	Pre 2014 Sill Outlet Drain Cover	BK	15633100
	Pre 2014 Sill Drain Cover	BG BZ	15633101 15633102
	Head Jamb Spacer Tack; Stationary Panel		11860424
	Jamb Spacer Tack; Stationary Panel 3/4" Diameter Head (replaced 7/16" diameter head)		11860423
	Stationary Panel Bracket Wood and Clad Field Service		11860216

WEATHER STRIP AND VINYL

When ordering replacement weather strip or vinyl parts, specify:



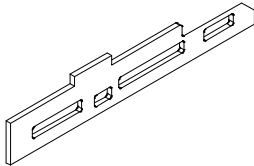
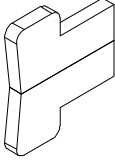

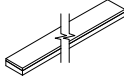
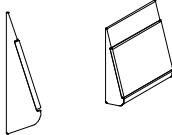
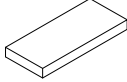
1. quantity;
2. length;
3. part number;
4. description.

ILLUSTRATION <i>NOT TO SCALE</i>	DESCRIPTION	LENGTH	COLOR	PART NUMBER
	Weather Strip, Sill V2026	47 1/8"	BG	11208440
		47 1/8"	BK	11208540
		62 5/16"	BG	11208454
		62 5/16"	BK	11208554
		82 5/16"	BG	11208470
		82 5/16"	BK	11208570
		105 1/2"	BG	11208490
		105 1/2"	BK	11208590
		164 11/16"	BG	11208499
164 11/16"	BK	11208599		
	Offset Bulb Weather Strip, Parting Stop, Frame, Mull Casing, Transom and Astragal V796	41 1/4"	BG	15171136
		92 7/8"	BG	15170082
		92 7/8"	BK	15170083
		164 13/16"	BG	15172140
		CN 9-0	BG	15170090
CN 9-0	BK	15170091		
	Weather Strip, Stile V020	CN 6-8	BG	11197968
		CN 8-0	BG	11197982
		Lineal	BG	11197999
		Lineal	BK	11197998
		CN 9-0	BG	11197990
		CN 9-0	BK	11197991
	Weather Strip, Panel Cover V018	150"	BG	11197799
		150"	BK	11197798
	Weather Strip, Inactive V1706	121"	BG	15618199
		121"	BK	15618299
	Panel Drip V2115	CN 1-6	BG	11199216
		CN 2-0	BG	11199220
		CN 2-6	BG	11199227
		CN 2-8	BG	11199228
		CN 3-0	BG	11199231
		CN 3-6	BG	11199236
		CN 2666	BG	11199226
		CN 3066	BG	11199230
		Lineal	BG	11199272
		CN 1-6	BK	11199316
		CN 2-0	BK	11199320
		CN 2-6	BK	11199327
		CN 2-8	BK	11199328
		CN 3-0	BK	11199331
		CN 3-6	BK	11199336
		CN 2666	BK	11199323
		CN 3066	BK	11199330
		Lineal	BK	11199372

WEATHER STRIP AND VINYL

ILLUSTRATION NOT TO SCALE	DESCRIPTION	LENGTH	COLOR	PART NUMBER	
	Frame Vinyl, Head Jamb V2114	17 11/16"	BG	11208016	
		29 5/16"	BG	11208026	
		31 5/16"	BG	11208028	
		35 5/16"	BG	11208030	
		46 1/2"	BG	11208040	
		58 1/2"	BG	11208050	
		62 1/2"	BG	11208054	
		70 1/2"	BG	11208060	
		82 1/2"	BG	11208070	
		56 7/8"	BG	11208051	
		68 7/8"	BG	11208061	
		93 11/16"	BG	11208080	
		105 11/16"	BG	11208090	
		116 7/8"	BG	11208010	
		124 7/8"	BG	11208011	
		140 7/8"	BG	11208012	
		164 7/8"	BG	11208099	
		29 5/16"	BK	11208226	
		31 5/16"	BK	11208228	
		35 5/16"	BK	11208230	
		46 1/2"	BK	11208240	
		58 1/2"	BK	11208250	
		62 1/2"	BK	11208254	
		70 1/2"	BK	11208260	
		82 1/2"	BK	11208270	
		105 11/16"	BK	11208290	
		124 7/8"	BK	11208211	
		140 7/8"	BK	11208212	
	164 7/8"	BK	11208299		
	2014 Frame Vinyl, Side Jamb V2114 <i>Usage:</i> 1/6/2014 to present	77 19/32"	BG	11209466	
		79 3/32"	BG	11209468	
		83 3/32"	BG	11209470	
		92 19/32"	BG	11209480	
104 19/32"		BG	11209490		
77 19/32"		BK	11209566		
79 3/32"		BK	11209568		
83 3/32"		BK	11209570		
92 19/32"		BK	11209580		
104 19/32"		BK	11209590		
Pre 2014 Frame Vinyl, Jamb V2114	LENGTH	COLOR	LH PART NUMBER	RH PART NUMBER	
	77 11/16"	BG	11208167	11208166	
	79 43/64"	BG	11208169	11208168	
	83 43/64"	BG	11208171	11208170	
	93 11/16"	BG	11208181	11208180	
	77 11/16"	BK	11208367	11208366	
	79 43/64"	BK	11208369	11208368	
	83 43/64"	BK	11208371	11208370	
	93 11/16"	BK	11208381	11208380	

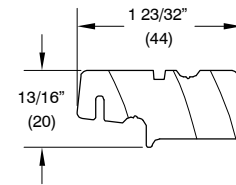
WEATHER STRIP AND VINYL

ILLUSTRATION <i>NOT TO SCALE</i>	DESCRIPTION	LENGTH	COLOR	PART NUMBER
	<p>Connecting Barb V803 NOTE: Color may vary depending on current stock.</p> <p>Wood Door, Wood and Clad Transom only</p>	Specify Length		15812999
	<p>Dust Block, Part Stop 1 3/8" x 3/8" x 1/2"</p>		GY BG	15600010 15600011
	<p>Pre 2014 Gasket, Sill to Jamb 4 9/16" Adhesive backed <i>Includes</i> 1 - LH and 1 - RH</p>		GY	15600020
	<p>Pre 2014 Corner Gasket Adhesive backed</p>		BK	10500434
	<p>Pre 2014 Gasket, Jamb Weather Strip 3/4" - Header Adhesive backed</p>		BK	10500576
	<p>Butyl Foam Tape 3/16" Width Adhesive backed</p>	25 FT Roll	BK	11406232
	<p>Sill Interior Filler Block V2077</p>		BG BZ	11124202 11124203
	<p>Part Stop Gasket Adhesive backed</p>		BK	15600028

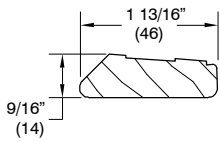
REPLACEMENT WOOD PARTS

ULTIMATE OUTSWING FRENCH DOOR

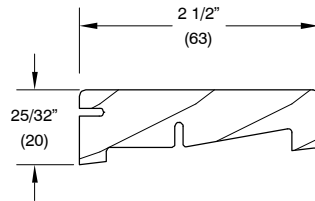
	Wood	Clad
Mulling Case Base	W10860	W10860
Sill Cover (Mahogany/Red Oak)	W10919	W10919
Sill Cover – In-Sash Transom	W11398	W11398
Sill Liner (Mahogany/Red Oak)	W10935	W10935
Jamb Stop	W11409	W11409
Mull Casing Cover	W10861	W10861
Sill Nosing – Transom – June 24, 2013 – present	W12059	
Top Rail Block – In-Sash Transom	W11533	W11533
Interior Glazing Bead Direct Glaze Transom June 24, 2013 – present	W11751	W11751
Interior Glazing Bead Direct Glaze Transom Pre-June 24, 2013	W4160	W4160



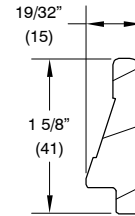
W10860 – Mulling Case Base



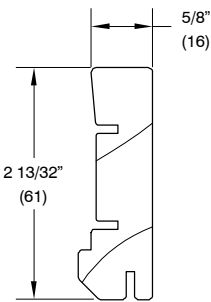
W10919 – Sill Cover
Oak – Standard
Cherry or Mahogany – Optional



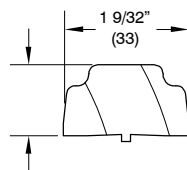
W11398 – Sill Cover Transom



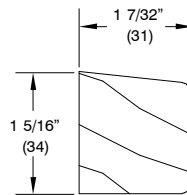
W10935 – Sill Liner
Oak – Standard
Cherry or Mahogany – Optional



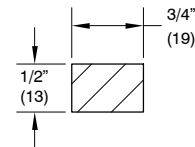
W11409 – Jamb Stop



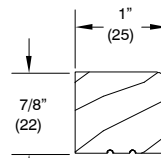
W10861 – Mull Case Cover



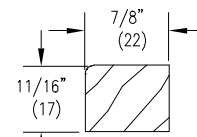
W12059 – Sill Nosing Transom



W11533 – Top Rail Block



W11751



W4160

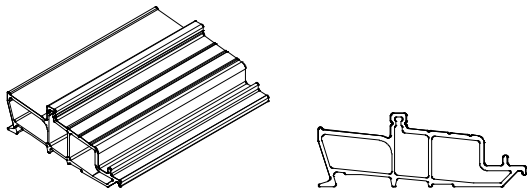
TO ORDER REPLACEMENT WOOD PARTS

When ordering replacement wood parts specify:

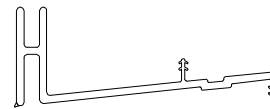
1. profile number;
2. rough opening;
3. handing;
4. length;
5. finish;
6. radius (if applicable).

**ORDERING REPLACEMENT VINYL, ALUMINUM OR FIBERGLASS PARTS FOR THE
 ULTIMATE OUTSWING FRENCH DOOR**

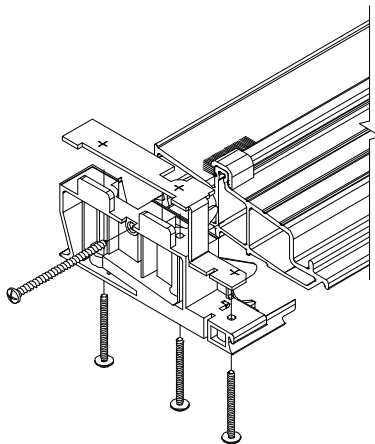
	Wood	Clad
Pre 2014 Ultrex Sill, 4 9/16" Jamb (includes weep system, sill liner and Weather Strip) – Beige or Bronze	F2050	F2050
2014 Ultrex Sill, 4 9/16" Jamb – Beige or Bronze	F2050	F2050
Sash Retainer (Transom) – Beige or Black	V026	V026
Sill Leveling Block (Transom) – Beige or Black	V2109	V2109
Active Astragal	A732	---



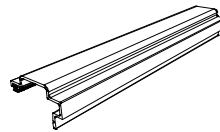
F2050 – Pre 2014 Ultrex Sill,
 4 9/16" Jamb



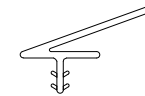
V2109 – Sill
 Leveling Block
 (In-Sash Transom)



F2050 – 2014 Ultrex Sill,
 4 9/16" Jamb



A732 – Active
 Astragal



V026 – Sash
 Retainer
 (Transom)

TO ORDER REPLACEMENT PARTS

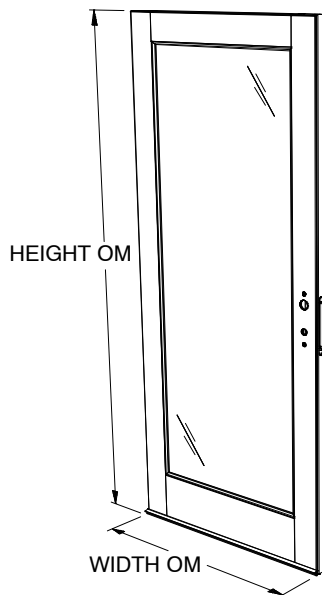
When ordering replacement parts specify:

1. profile number;
2. rough opening;
3. length;
4. handing;
5. finish (where applicable).

ORDERING REPLACEMENT PANELS FOR THE WOOD AND CLAD ULTIMATE OUTSWING FRENCH DOOR

To order replacement panels specify:

1. OM of panel;
NOTE: OM of panel does not include astragal, mull casing or sweep.
2. active, inactive or stationary
 - a. Active – specify no lock (no bore), bore for passage latch/dead bolt, single–point mortise lock or multi–point mortise lock .
 - b. Inactive – specify head or foot bolts or multi–point mortise lock. For inactive panels with head bolts, if panel being replaced was manufactured before 8/28/16 and panel height OM is greater than 95” order appropriate Inactive Panel Top Flush Bolt Assembly.
 - c. Stationary – specify configuration and astragal or mull casing (if applicable).
 - d. Panel style.
3. handing;
4. glazing;
5. finish;
6. glazing bead profile
 - a. bevel
 - b. square



**Wood Active Panel
Exterior View**



**Clad Active Panel
Exterior View**

NOTE: Weather Strip is included with all panels (where applicable).

Active panels include panel sweep, bored for passage/dead bolt, single–point mortise lock, or multi–point mortise lock system.

Inactive panels include panel sweep, astragal, configured for head and foot bolts or multi–point lock system.

Stationary 1 wide panels include panel sweep and sill bolts.

Stationary 2, 3 or 4 wide panels include panel sweep, sill bolts and mull casing.

ORDERING ENERGY PANELS FOR SINGLE GLAZED WOOD ULTIMATE OUTSWING FRENCH DOOR

If you are replacing an existing energy panel, determine the outside measurement of the existing energy panel. Find the sizes that correspond to the width and height indicated on the following chart. Energy panels are available for the single glazed Wood Ultimate Outswing French Doors. Aluminum surrounds are available in bronze or stone white.

Energy panels are attached with turn buttons. Turn button styles may vary depending on current stock. You will receive the most current style in the color of your choice. (Discontinued black turn buttons will be replaced by brown.) Turn buttons can be found in the Miscellaneous Mouldings chapter of the Parts Manual

When ordering energy panels specify:

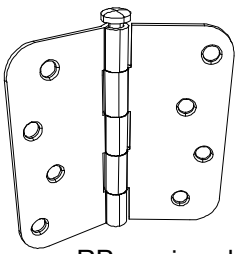
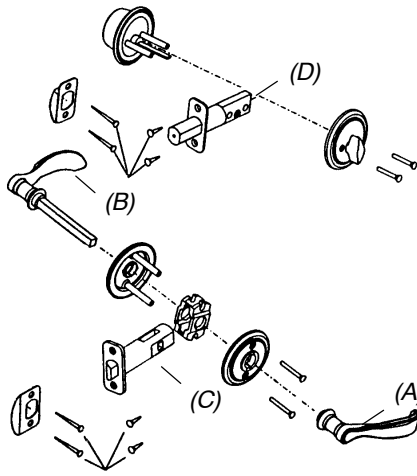
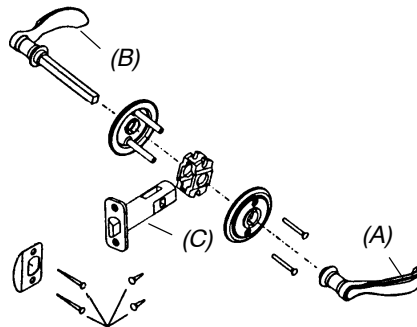
1. size; If there is no existing EP from which to obtain the OM of the panel, determine the size of the EP by using the conversion chart below. The daylight opening is the measurement of the visible glass.
2. color of surround;
3. glass type;

Single Glazed Wood Ultimate Outswing				
Wood Ultimate Outswing French Doors				
manufactured 1/17/00 – Present				
Daylight Opening to OM of EP				
Daylight Width + 1 3/8" = OM Width of EP				
Daylight Height + 1 3/8" = OM Height of EP				
WIDTH			HEIGHT	
SIZE	(65 ht.)	OM-WIDTH	SIZE	OM-HEIGHT
CN 16		12 7/8"	CN 65	64 1/4"
CN 26		19 15/32"		
CN 30		25 15/32"		
CN 16	(66R ht.)	12 7/8"	CN 66R	65"
CN 26R		20 5/32"		
CN 30R		26 5/32"		
CN 16		12 7/8"	CN 68	67 1/2"
CN 20		14 31/32"	CN 70	71 1/2"
CN 26		20 31/32"	CN 80	81"
CN 28		22 31/32"		
CN 30		26 31/32"		
CN 36		32 31/32"		

OBSOLETE PARTS

When ordering replacement parts specify:



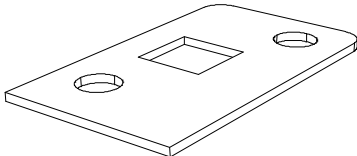
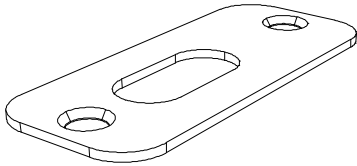

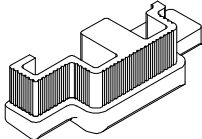
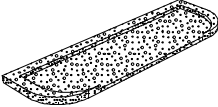
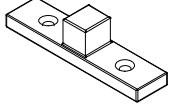
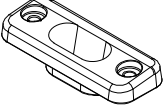
1. type of unit;
2. part number;
3. description.

ILLUSTRATION NOT TO SCALE	DESCRIPTION	OPER./CO LOR	PART NO.
 <p>RP version shown</p>	<p>Hinge, Outswing Doors Wood Outswing French Door 1989 – 1/17/00. Clad Outswing French Door 1990 – 1/17/00. Includes: 1 – 4” hinge 4 – #10x1” Phillips flathead wood screws (panel) 3 – #10x3/4” Phillips flathead wood screws (frame) 1 – #10x2 1/2” Phillips flathead wood screws (frame) Brass</p>	<p><u>Solid Brass</u> RP <u>SS</u> NRP RP</p>	<p>NA</p>
	<p>Lever Set, Complete, Solid Brass Wood Outswing French Door 1989 – 1/17/00. Clad Outswing French Door 1990 – 1/17/00. Schlage “C” Keyway Includes: 1 – Solid brass interior passage handle (A) 1 – Solid brass exterior passage handle (B) with spindle 1 – Passage latch assembly (C) with cover plates and 05700003 strike plate 1 – Deadbolt assembly (D) with cover plates and 05700002 strike plate 2 – Keys 1 – Installation screw package with Allen wrench and instructions</p>		<p>10144000 Check for availability</p>
	<p>Lever Set, Solid Brass Wood Outswing French Door 1989 – 1/17/00. Clad Outswing French Door 1990 – 1/17/00. Includes: 1 – Solid brass interior passage handle (A) 1 – Solid brass exterior passage handle (B) with spindle 1 – Passage latch assembly (C) with cover plates and 05700003 strike plate 1 – Installation screw package with Allen wrench and instructions</p>		<p>N/A</p>

OBSOLETE PARTS

ILLUSTRATION NOT TO SCALE	DESCRIPTION	OPER./CO LOR	PART NO.
	<p>Lever Set, Dummy (with dummy deadbolt), Solid Brass Wood Outswing French Door 1989 – 1/17/00. Clad Outswing French Door 1990 – 1/17/00. Includes: 1 – Solid brass dummy interior passage handle (A) with cover plate 1 – Solid brass dummy exterior passage handle (B) with spindle and cover plate 1 – Dummy deadbolt assembly (C) with cover plate 1 – Installation screw package with instructions</p>		NA
	<p>Lever Set, Dummy, Solid Brass Wood Outswing French Door 1989 – 1/17/00. Clad Outswing French Door 1990 – 1/17/00. Includes: 1 – Solid brass dummy interior passage handle (A) with cover plate 1 – Solid brass dummy exterior passage handle (B) with spindle and cover plate 1 – Installation screw package with instructions</p>		NA
	<p>Strike Plate, Lever Set, Solid Brass Wood Outswing French Door 1989 – 1/17/00. Clad Outswing French Door 1990 – 1/17/00. Includes: 1 – Strike plate 2 – #6x2” Phillips flathead wood screws</p>		NA
	<p>Strike Plate, Deadbolt, Solid Brass Wood Outswing French Door 1989 – 1/17/00. Clad Outswing French Door 1990 – 1/17/00. Includes: 1 – Strike plate 2 – #6x2” Phillips flathead wood screws</p>		NA
	<p>Strike Plate, Lever Set, Solid Brass Wood Ultimate Outswing French Door 1989 – 1/17/00. Clad Outswing French Door 1990 – 1/17/00. For single panel door Includes: 1 – Strike plate 4 – #6x2” Phillips flathead wood screws</p>		NA
	<p>Extension Rod Wood Outswing French Door 1989 – 1/17/00. Clad Outswing French Door 1990 – 1/17/00. For head or foot bolt</p> <p style="text-align: right;">9 11/16” 25 11/16”</p>		16152002 NA
	<p>Stop clip with screws NA as individual part – 02–2011</p>		NA

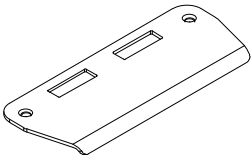
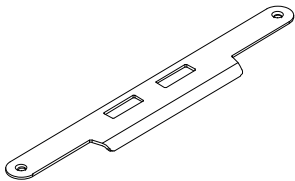

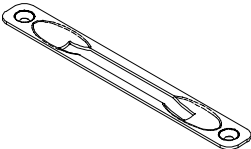
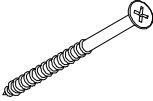
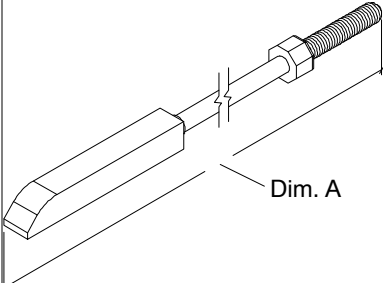
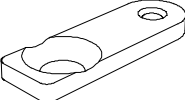
OBSOLETE PARTS

ILLUSTRATION NOT TO SCALE	DESCRIPTION	OPER./CO LOR	PART NO.
	<p>Inactive Panel Flush Bolt <i>3/16" radius corners, replace with current flush bolt (1/4" radius corners)</i> Includes: 1 – Flush bolt 4 – #6 x 1 1/2" Phillips flathead wood screws</p>	Brass Antique Brass Polished Chrome Chrome Brushed Chrome White	NA
	<p>End Bolt – Head/Foot Bolt <i>Wood Outswing French Door 1989 – 1/17/00. Clad Outswing French Door 1990 – 1/17/00.</i></p>		No longer available
	<p>Head or Foot Bolt Guide Plate <i>Wood Ultimate Outswing French Door 1989 – 1/17/00. Clad Outswing French Door 1990 – 1/17/00.</i> Includes: 1 – Guide plate 2 – #6x1 1/2" Phillips flathead wood screws</p>	ZYD	No longer available
	<p>Head or Foot Bolt Strike Plate <i>Wood Outswing French Door 1989 – 1/17/00. Clad Outswing French Door 1990 – 1/17/00.</i> Includes: 1 – Foot bolt guide plate 2 – #6x3/8" Phillips flathead wood screws</p>	Solid Brass Polished Chrome Brushed Chrome	N/A NA NA
	<p>Foot Bolt Receiver Cup <i>Wood Outswing French Door 1989 – 1/17/00. Clad Outswing French Door 1990 – 1/17/00.</i></p>	BG	16152015 Check for Availability.
	<p>Active Astragal Bottom Cap <i>Clad Outswing French Door 1990 – 1/17/00.</i> Clad Outswing door only</p>	LH BG RH BG	11867701 11867700
	<p>Hinge Pocket Gasket, Butyl <i>Clad Outswing French Door 1990 – 1/17/00.</i> Clad Outswing door only</p>		NA
	<p>Sill Bolt, Stationary Panel (pre 07/2012) Includes: 2 – #8 x 3" Phillips flathead wood screws (11800830)</p>	Zinc Die Cast	NA
	<p>Strike, Sill (pre 07/2012) Includes: 1 – Strike plate 2 – #8 x 5/8" Phillips trusshead stainless steel machine screws (sill) (11800726) 2 – Well-nut threaded insert 10830008</p>	BG BZ	18900365 18900368

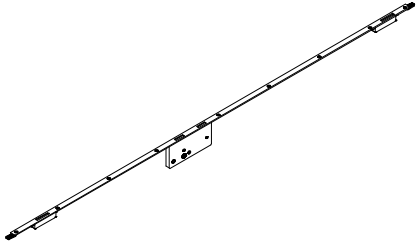
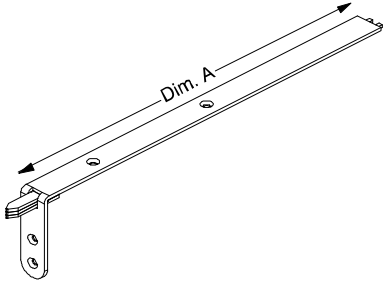
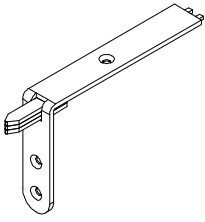
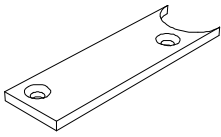
OBSOLETE PARTS

ILLUSTRATION NOT TO SCALE	DESCRIPTION	OPER./CO LOR	PART NO.
	<p>Multi-Point Handle, Active, Solid Brass (Essve) Wood Outswing French Door 1989 – 1/17/00. Clad Outswing French Door 1990 – 1/17/00. (Weiser keyway before 7/97) (Schlage keyway 7/97 to present) Includes: 1 – Interior handle (A) with escutcheon plate and thumb turn 1 – Exterior handle (B) with escutcheon plate and keyed cylinder 1 – Spindle (C) 2 – Escutcheon mounting extensions (D) 1 – Jamb strike (center) (E) 2 – Keys 2 – #10 – 24x1 1/2" Phillips ovalhead machine screws 4 – #7x5/8" Phillips flathead wood screws (Strike)</p>	<p>LH RH</p>	<p>NA (Current handle can be used by turning it upside down)</p>
	<p>Multi-Point Handle, Inactive, Solid Brass (Essve) Wood Outswing French Door 1989 – 1/17/00. Clad Outswing French Door 1990 – 1/17/00. Includes: 1 – Interior handle (A) with escutcheon plate 1 – Exterior handle (B) with escutcheon plate 1 – Spindle (C) 2 – Escutcheon mounting extensions (D) 2 – #10–24x1 1/2" Phillips ovalhead machine screws</p>	<p>LH RH</p>	<p>NA (Current handle can be used by turning it upside down)</p>
	<p>Spindle Package for Multi-Point Handle (Essve) Wood Outswing French Door 1989 – 1/17/00. Clad Outswing French Door 1990 – 1/17/00. Includes: 1 - Spindle 2 - Escutcheon mounting extensions</p>		<p>NA</p>
	<p>Active Multi-Point Hardware Assembly (Essve) Wood Outswing French Door 1989 – 1/17/00. Clad Outswing French Door 1990 – 1/17/00. Includes: 1 – Multi-Point hardware assembly (with mortise locks) 9 – #6x1 1/2" Phillips flathead wood screws</p>	<p>CN 6-5, 6-8 or 7-0 ht. CN 8-0 ht.</p> <p>LH RH LH RH</p>	<p>NA</p>

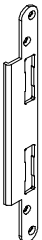
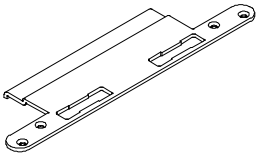
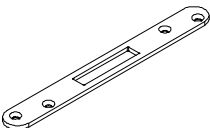
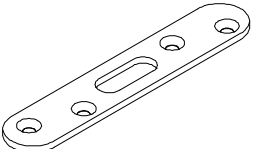
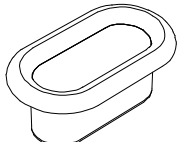
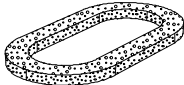
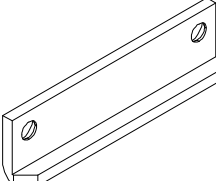
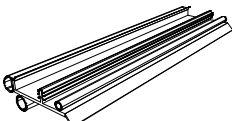
OBSOLETE PARTS

ILLUSTRATION NOT TO SCALE	DESCRIPTION	OPER./COLOR	PART NO.				
	<p>Strike Plate, Jamb – Mortise Lock or Multi-Point Lock 1/17/00 – 3/31/03(Amerock) Includes: 1 – Jamb strike plate 2 – #8x1” Brass Phillips flathead wood screws</p>	Polished Chrome Brushed Chrome White	NA				
	<p>Strike Plate, Panel – Mortise Lock or Multi-Point Lock 1/17/00 – 3/31/03 (Amerock) Includes: 1 – Jamb strike plate 2 – #8x1” Brass Phillips flathead wood screws</p>	Polished Chrome Brushed Chrome White	NA				
	<p>Cover Plate, Active Panel – Mortise Lock or Multi-Point Lock 1/17/00 – 3/31/03 (Amerock) Includes: 1 – Cover plate 2 – #8x1” Phillips flathead wood screws</p>	Polished Chrome Brushed Chrome White	NA				
	<p>Cover Plate for Flush Bolt Includes: 1 – Cover plate 2 – #9 x 1” Screws</p>	Polished Chrome Brushed Chrome White Brass Antique Brass PVD Brass	NA				
	<p>Installation Screw Package; Strike Plate(s) at head jamb, or locking jamb FD – std. UFD – std. #8 x 3” Flathead wood screw Package of 4</p>	White	11882348				
 <p>Dim. A</p>	<p>Locking Rod Assembly, Top – Multi-Point Lock 3/02– Present (Amerock) 8–0 Height see History 5/10/90 – Present (Amerock) 6–5, 6–8, & 7–0 Height Solid stainless steel rod with 1/4” – 20 threads NOTE: For special heights give dimension A.</p> <table border="1" data-bbox="574 1625 899 1709"> <thead> <tr> <th>Height</th> <th>Top Locking Rod Length</th> </tr> </thead> <tbody> <tr> <td>CN 6–5 ht</td> <td>34 11/16”</td> </tr> </tbody> </table>	Height	Top Locking Rod Length	CN 6–5 ht	34 11/16”	Stainless Steel	05700175
Height	Top Locking Rod Length						
CN 6–5 ht	34 11/16”						
	<p>Inactive Panel Backset Extension – Head or Foot Flush Bolt With 1/4” – 20 threads Includes: 1 – Backset extension 1 – 1/4” –20 x3/4” Phillips flathead machine screw</p>		16152011				

OBSOLETE PARTS

ILLUSTRATION NOT TO SCALE	DESCRIPTION	OPER./COLOR	PART NO.
	<p>Inactive Multi-Point Hardware Assembly (Essve) Wood Outswing French Door 1989 – 1/17/00. Clad Outswing French Door 1990 – 1/17/00. Includes: 1 – Inactive multi-point hardware assembly 9 – #6X1 1/2" phillips flathead wood screws CN 6-5, 6-8 and 7-0 ht. CN 8-0 ht.</p>		NA
	<p>Multi-Point Top Corner Drive (Essve) Wood Ultimate Outswing French Door 1989 – 1/17/00. Clad Outswing French Door 1990 – 1/17/00. For Inactive panel with multi-point Includes: 1 – Top corner drive Attached with #6x1/2" Phillips flathead wood screws CN 6-8 ht. 7 29/64" (189) CN 7-0 ht. 11 15/32" (291) CN 8-0 ht. 10 5/16" (262) CN 6-5 ht. 3 3/4" (95) NOTE: For special heights give Dimension A.</p>		NA
	<p>Multi-Point Bottom Corner Drive (Essve) Wood Outswing French Door 1989 – 1/17/00. Clad Outswing French Door 1990 – 1/17/00. For Inactive panel with multi-point 4 13/32" (112) Includes: 1 – Bottom corner drive 3 – #6x1/2" Phillips flathead wood screws</p>		NA
	<p>Corner Drive Filler; Multi-Point Lock (Essve) Wood Outswing French Door 1989 – 1/17/00. Clad Outswing French Door 1990 – 1/17/00. Includes: 1 – Corner drive filler 2 – #6 x 1 1/2" Phillips flathead wood screws</p>		NA

OBSOLETE PARTS

ILLUSTRATION NOT TO SCALE	DESCRIPTION	PART NO.
	<p>Jamb Strike, Center, Solid Brass; Multi-Point Lock (Essve) <i>Wood Outswing French Door 1989 – 1/17/00.</i> <i>Clad Outswing French Door 1990 – 1/17/00.</i> Includes: 1 – Jamb strike 4 – #7 x 5/8" Phillips flathead wood screws</p>	NA
	<p>Jamb Strike, Center, Extended, Solid Brass; Multi-Point Lock (Essve) <i>Wood Outswing French Door 1989 – 1/17/00.</i> <i>Clad Outswing French Door 1990 – 1/17/00.</i> Includes: 1 – Extended jamb strike 4 – #7x5/8" Phillips flathead wood screws</p>	NA
	<p>Jamb Strike, Top or Bottom, Solid Brass; Multi-Point Lock (Essve) <i>Wood Outswing French Door 1989 – 1/17/00.</i> <i>Clad Outswing French Door 1990 – 1/17/00.</i> Includes: 1 – Jamb strike 4 – #7 x 5/8 Phillips flathead screws</p>	NA
	<p>Strike, Inactive Panel, Head Jamb; Multi-Point Lock (Essve) <i>Wood Outswing French Door 1989 – 1/17/00.</i> <i>Clad Outswing French Door 1990 – 1/17/00.</i> Includes: 1 – Strike 4 – #7x5/8" Phillips flathead wood screws</p>	NA
	<p>Corner Drive Sill Receptacle, Solid Brass; Multi-Point Lock (Essve) <i>Wood Outswing French Door 1989 – 1/17/00.</i> <i>Clad Outswing French Door 1990 – 1/17/00.</i></p>	NA
	<p>Sill Receptacle Gasket; Multi-Point Lock <i>Wood Outswing French Door 1989 – 1/17/00.</i> <i>Clad Outswing French Door 1990 – 1/17/00.</i> For corner drive sill receptacle</p>	NA
	<p>Astragal Strike Latch; Multi-Point Lock (Essve) <i>Wood Outswing French Door 1989 – 1/17/00.</i> <i>Clad Outswing French Door 1990 – 1/17/00.</i> Inactive panel with multi-point hardware Includes: 1 – Latch 2 – #7x5/8" Phillips flathead wood screws</p>	NA
	<p>Sweep V212 <i>Wood Outswing French Door 1989 – 1/17/00.</i> <i>Clad Outswing French Door 1990 – 1/17/00.</i></p>	<p>144" BG 11187095</p>

OUTSWING FRENCH DOORS / ULTIMATE OUTSWING FRENCH DOOR
OBSOLETE PARTS

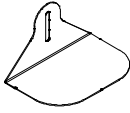
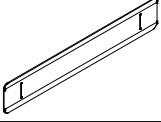

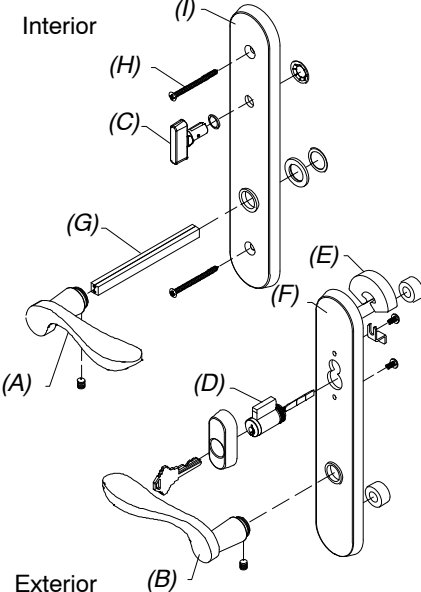
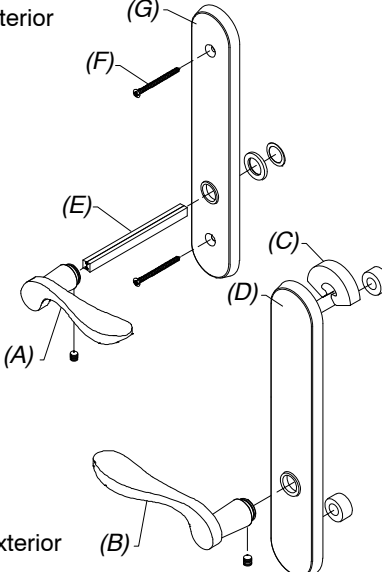
ILLUSTRATION <i>NOT TO SCALE</i>	DESCRIPTION	OPER./COLOR	PART NO.
	Bracket, Jamb-Align		N/A
	Receiver, Jamb Align		N/A

ILLUSTRATION NOT TO SCALE	DESCRIPTION	OPER./CO LOR	PART NO.
	<p>Contemporary Handle Assembly, Active Panel Mortise lock and Multi-point lock systems (Schlage "C" keyway) Includes: 1 - Interior lever (A) with 10148414 spindle, escutcheon plate and hardware 1 - Exterior lever (B) with escutcheon plate and hardware 1 - Thumb turn (C) with hardware 1 - Keyed cylinder (D) with housing and hardware 1 - Exterior escutcheon plate gasket (E) 1 - Exterior escutcheon plate (F) 1 - Two piece spindle (G) 2 - M5 x 55mm Phillips ovalhead machine screws (H) 1 - Interior escutcheon plate (I) 1 - Thumb turn washer (J) 1 - Thumb turn push nut (K) 2 - Keys</p>	<p>TP</p>	<p>11102150</p>
	<p>Contemporary Handle Assembly, Inactive/Dummy Includes: 1 - Interior lever (A) with 00142006 spindle, escutcheon plate and hardware 1 - Exterior lever (B) with escutcheon plate and hardware 1 - Exterior escutcheon plate gasket (C) 1 - Exterior escutcheon plate (D) 1 - Two piece spindle (E) 2 - M5 x 55mm Phillips ovalhead machine screws (F) 1 - Interior escutcheon plate (G)</p>	<p>TP</p>	<p>11102153</p>
	<p>Thumb Turn (C) NOTE: For each thumb turn, order one thumb turn washer -10148423(J) and one thumb turn push nut 10148424(K).</p>	<p>TP</p>	<p>10148425</p>

ILLUSTRATION NOT TO SCALE	DESCRIPTION	OPER./CO LOR	PART NO.
	<p>Head or Foot Flush Bolt – Inactive Panel OLCD, FD, UFD, std.</p> <p>Includes: 1 – Head or foot bolt 4 – #6 x 3/4" Phillips flathead wood screws</p>	<p>SB AB PC WH</p>	<p>11101765 NA NA NA</p>
	<p>Handle Assembly, Active Panel Mortise Lock and Multi-Point Locks (Schlage "C" keyway)</p> <p>Includes: 1 – Interior lever (A) with 00142006 spindle, escutcheon plate and hardware 1 – Exterior lever (B) with escutcheon plate and hardware 1 – Thumb turn (C) with hardware 1 – Keyed cylinder (D) with housing and hardware 1 – Exterior escutcheon plate gasket (E) 1 – Exterior escutcheon plate (F) 1 – Two piece spindle (G) 2 – #10-32x2" Phillips ovalhead machine screws (H) 1 – Interior Escutcheon plate (I) 2 – Keys</p>	<p>Polished Chrome</p> <p>Brushed Chrome</p>	<p>10148117</p> <p>10148118</p>
	<p>Handle Assembly, Inactive/Dummy Inactive Panel with Flush bolts</p> <p>Includes: 1 – Interior lever (A) with 00142006 spindle, escutcheon plate and hardware 1 – Exterior lever (B) with escutcheon plate and hardware 1 – Exterior escutcheon plate gasket (C) 1 – Exterior escutcheon plate (D) 1 – Two piece spindle (E) 2 – #10-32x2" Phillips ovalhead machine screws (F) 1 – Interior Escutcheon plate (G)</p>	<p>Polished Chrome</p> <p>Brushed Chrome</p>	<p>10148148</p> <p>10148149</p>

OBSOLETE PARTS

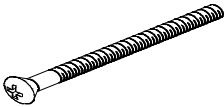
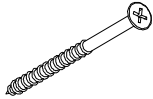
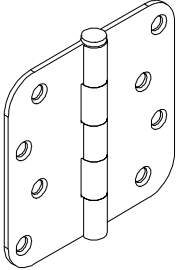
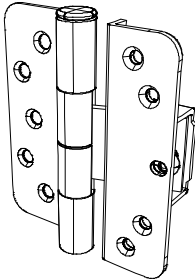
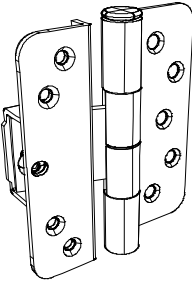
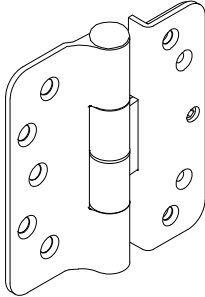
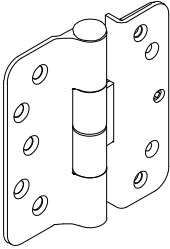
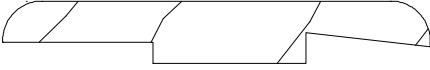
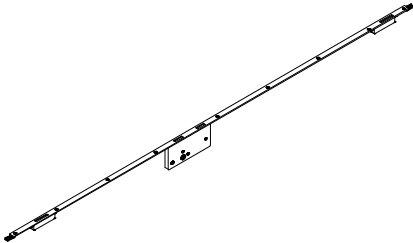
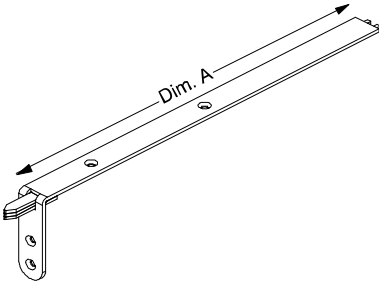
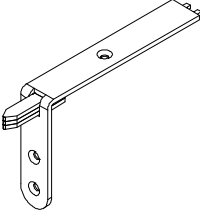
ILLUSTRATION NOT TO SCALE	DESCRIPTION	OPER./COLOR	PART NO.		
	#10-32x2" Phillips ovalhead machine screws	Polished Chrome	NA		
	Installation Screw Package; Strike Plate(s) at head jamb, sill, or locking jamb #8 x 2 1/2" Flathead wood screw Package of 4	White	11882348		
	Hinge, Ball Bearing OLCD Includes: 1 - Ball bearing hinge 8 - #12 x 1 1/4" Phillips flathead wood screws NOTE: Screws are packaged with hinges from manufacturer, no part number available.	Solid Brass Satin Chrome	02100578 NA		
	Hinge, Adjustable, Left Hand 2000-2005 Includes: 1 - #10 x 2 1/2" Phillips flathead wood screws (jamb) 4 - #10 x 1" Phillips flathead wood screws (jamb) or 5 - #10 x 1" Phillips flathead wood screws (stationary stile) 4 - #8 x 1 1/2" Phillips flathead wood screws (panel) 1 - 5/32" Allen wrench (adjustment)	Polished Chrome Satin Taupe Gold Tone Silver Frost Dark Bronze White	NA Use pre-2012 hinge <i>Note: The current adjustable hinge kit may also be used. If using the current hinge, all hinges on the panel must be changed.</i>		
	Hinge, Adjustable, Right Hand 2000-2005 Includes: 1 - #10 x 2 1/2" Phillips flathead wood screws (jamb) 4 - #10 x 1" Phillips flathead wood screws (jamb) or 5 - #10 x 1" Phillips flathead wood screws (stationary stile) 4 - #8 x 1 1/2" Phillips flathead wood screws (panel) 1 - 5/32" Allen wrench (adjustment)	Polished Chrome Satin Taupe Gold Tone Silver Frost Dark Bronze White	NA Use pre-2012 hinge <i>Note: The current adjustable hinge kit may also be used. If using the current hinge, all hinges on the panel must be changed.</i>		
	Hinge, Adjustable Includes: 1 - #10x2 1/2" Phillips flathead wood screws (jamb) 4 - #10x1" Phillips flathead wood screws (jamb) or 5 - #10x1" Phillips flathead wood screws (stationary stile) 4 - #8x1 1/2" Phillips flathead wood screws (panel) 1 - 5/32" Allen wrench (adjustment)	Polished Chrome	<table border="1"> <tr> <td data-bbox="1226 1625 1481 1787">Right Hand 02101116</td> </tr> <tr> <td data-bbox="1226 1787 1481 1936">Left Hand 02101115</td> </tr> </table>	Right Hand 02101116	Left Hand 02101115
Right Hand 02101116					
Left Hand 02101115					

ILLUSTRATION NOT TO SCALE	DESCRIPTION			
	<p>Hinge, Adjustable USAGE: Pre-2012</p> <p><i>Includes:</i> 1 - Adjustable hinge 1 - #10x2 1/2" Phillips flathead wood screws (jamb) 5 - #10x1" Phillips flathead wood screws 4 - #8x1 1/2" Phillips flathead wood screws</p> <p>NOTE: Hinge part number includes the color matched screws. If you need to order the screws separately, they are listed below aligned with the corresponding hinge color.</p>			
SCREW DESCRIPTION	HINGE COLOR/PART NO.		SCREW COLOR/PART NO.	
		LH	RH	
#10x2 1/2" Phillips flathead wood screws (jamb). Quantity of one needed per hinge.	TP GT SF DKBZ* DKBZ AB WH SC ORBZ ORBZ PVD BS PVD SN PVD	NA** NA** NA** NA** NA** NA** NA** NA** NA** NA** NA** NA** NA**	NA** NA** NA** NA** NA** NA** NA** NA** NA** NA** NA** NA** NA**	TP GT SS DKBZ DKBZ DKBZ WH SS DKBZ DKBZ BS PVD SS 11800683 11800681 11800684 11800680 11800680 11800680 11800682 11800684 11800684 11800680 11800680 11800679 11800684
#10x1" Phillips flathead wood screws. Quantity of 5 needed per hinge.	TP GT SF DKBZ* DKBZ AB WH SC ORBZ ORBZ PVD BS PVD SN PVD	NA** NA** NA** NA** NA** NA** NA** NA** NA** NA** NA** NA** NA**	NA** NA** NA** NA** NA** NA** NA** NA** NA** NA** NA** NA** NA**	TP GT SS DKBZ DKBZ DKBZ WH SS DKBZ DKBZ BS PVD SS 05580145 11800606 11800605 02050526 02050526 02050526 11800603 11800605 02050526 02050526 11800600 11800605
#8x1 1/2" Phillips flathead wood screws (panel). Quantity of four needed per hinge.	TP GT SF DKBZ* DKBZ AB WH SC ORBZ ORBZ PVD BS PVD SN PVD	NA** NA** NA** NA** NA** NA** NA** NA** NA** NA** NA** NA** NA**	NA** NA** NA** NA** NA** NA** NA** NA** NA** NA** NA** NA** NA**	TP GT SS DKBZ DKBZ DKBZ WH SS DKBZ DKBZ BS PVD SS 11865177 11865172 11865175 02058013 02058013 02058013 11865173 11865175 02058013 02058013 11865176 11865175

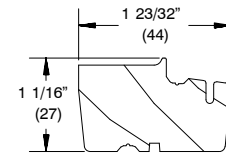
* Used prior to April, 2010
** Contact your Marvin representative.

OBSOLETE PARTS

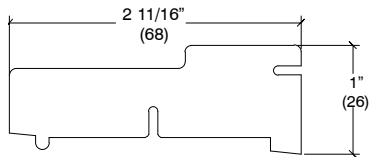
ILLUSTRATION NOT TO SCALE	DESCRIPTION	OPER./COLOR	PART NO.
	<p>Sill Cover W9510 <i>"Pre 2012"</i></p>	<p><u>Oak</u> 36" (914) 72" (1829) 96" (2438)</p> <p><u>Mahogany</u> 36" (914) 72" (1829) 96" (2438)</p>	<p>71400936 71400972 71400996</p> <p>71400937 71400973 71400997</p>
	<p>Inactive Multi-Point Hardware Assembly (Essve) <i>Wood Outswing French Door 1989 – 1/17/00.</i> <i>Clad Outswing French Door 1990 – 1/17/00.</i> Includes: 1 – Inactive multi-point hardware assembly 9 – #6X1 1/2" phillips flathead wood screws CN 6-5, 6-8 and 7-0 ht. CN 8-0 ht.</p>		<p>NA</p>
	<p>Multi-Point Top Corner Drive (Essve) <i>Wood Ultimate Outswing French Door 1989 – 1/17/00.</i> <i>Clad Outswing French Door 1990 – 1/17/00.</i> For Inactive panel with multi-point Includes: 1 – Top corner drive Attached with #6x1/2" Phillips flathead wood screws CN 6-8 ht. 7 29/64" (189) CN 7-0 ht. 11 15/32" (291) CN 8-0 ht. 10 5/16" (262) CN 6-5 ht. 3 3/4" (95) NOTE: For special heights give Dimension A.</p>		<p>NA</p>
	<p>Multi-Point Bottom Corner Drive (Essve) <i>Wood Outswing French Door 1989 – 1/17/00.</i> <i>Clad Outswing French Door 1990 – 1/17/00.</i> For Inactive panel with multi-point 4 13/32" (112) Includes: 1 – Bottom corner drive 3 – #6x1/2" Phillips flathead wood screws</p>		<p>NA</p>

ULTIMATE OUTSWING FRENCH DOOR – PRE-2012

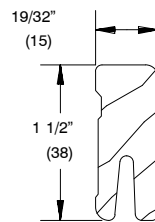
	Wood	Clad
First Mull Casing and Astragal	W1455	
Sill Cover – Transom	W2136	W2136
Sill Liner (oak)	W2528	W2528
Jamb Stop	W6531	W6531
Astragal Cover and Transom Mull Cover	W7554	
Stationary Sweep Filler	W12495	
Sill Nosing – Transom – Pre-June 24, 2013	W8653	
Exterior Part Stop – Transom – Pre-June 24, 2013	W8474	



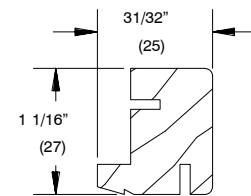
W1455 – First Mull Casing and Astragal– Wood



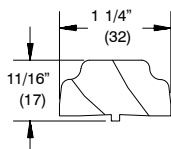
W2136 – Sill Cover Transom



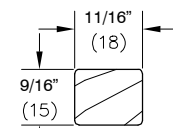
W2528 – Sill Liner (oak)



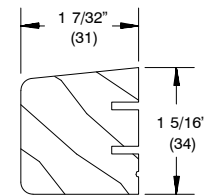
W6531 – Jamb Stop



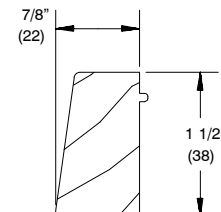
W7554 – Astragal Cover and Transom Mull Cover – Wood



W12495 – Stationary Sweep Filler



W8653 – Sill Nosing Transom – Pre-June 24, 2013



W8474 – Exterior Part Stop Transom Pre-June 24, 2013

TO ORDER REPLACEMENT WOOD PARTS

When ordering replacement wood parts specify:

1. profile number;
2. rough opening;
3. handing;
4. length;
5. finish;
6. radius (if applicable).

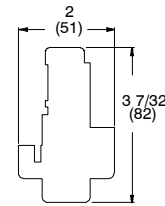
REPLACEMENT WOOD PARTS

OUTSWING FRENCH DOOR

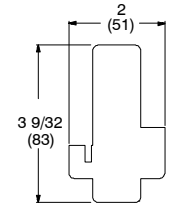
Wood Ultimate Outswing French Door 1989 – 1/17/00.
Clad Outswing French Door 1990 – 1/17/00.

	Clad	Wood
Astragal	W7232	W7222
Astragal (Multi-Point)	W7233	W7219
Operator First Mull Casing	W1092	W1092
Second Mull Casing	W1081	W1081
Stationary Head Jamb, Jamb and Astragal Filler	W6040*	W6040*
Stationary Head Jamb and Jamb Spacer	W6220*	W6220*
Stationary Jamb Filler (1 panel)	W7234*	W7234*
Stationary Jamb Filler (Multi-panel)	W7235*	W7235*

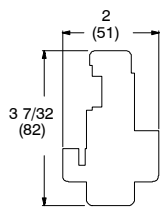
* No longer available.



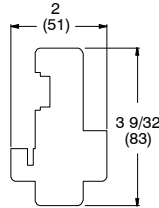
W7232 – Inactive Astragal



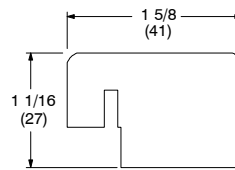
W7222 – Astragal



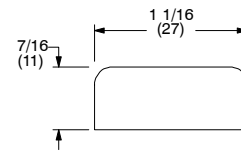
W7233 – Inactive Astragal (Multi-Point)



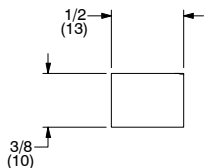
W7219 – Astragal (Multi-Point)



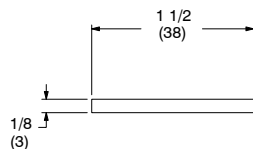
W1092 – Operator First Mull Casing



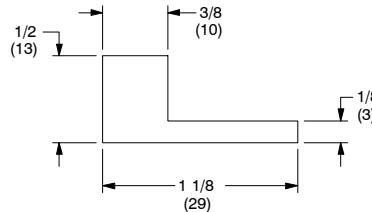
W1081 – Second Mull Casing



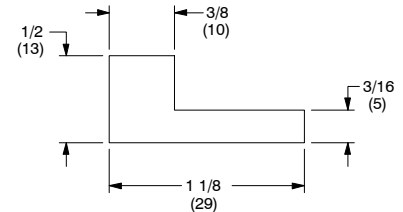
W6040* – Stationary Head Jamb, Jamb and Astragal Filler
 NA



W6220* – Stationary Head Jamb and Jamb Spacer
 NA



W7234* – Stationary Jamb Filler (1 panel)
 NA



W7235* – Stationary Jamb Filler (Multi-panel)
 NA

TO ORDER REPLACEMENT WOOD PARTS

When ordering replacement wood parts specify:

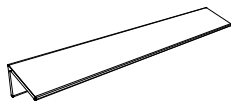
1. profile number;
2. call number or rough opening;
3. handing;
 - a. for operator first mull casing specify right or left hand (as viewed from the exterior)
 - b. for astragal specify hardware prep (if applicable)
4. length;
5. finish;
6. radius (if applicable).

**ORDERING REPLACEMENT VINYL, ALUMINUM OR FIBERGLASS PARTS FOR THE
 OUTSWING FRENCH DOOR**

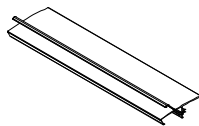
*Wood Ultimate Outswing French Door 1989 – 1/17/00.
 Clad Outswing French Door 1990 – 1/17/00.*

	Clad	Wood
Panel Drip	V251	---
Panel Cap – Beige	V360	V360
Stationary and Sidelite Leveling Block – Beige	V770*	V770*
Active Astragal	A732	---
Inactive Astragal Cladding (Multi-Point)	A733	---
Inactive Astragal Cladding (non Multi-Point)	A721	---
Ultrex Sill – Beige	F252*	F252*
Ultrex Sill, 4 9/16" Jamb (includes weep system, sill liner and Weather Strip) – Beige or Bronze	F256	F256

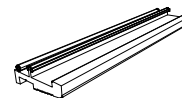
* No longer available.



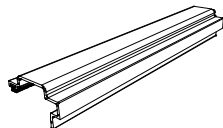
V251 – 12' 6" Panel Drip
 15801099 WH,
 15801299 PB,
 15801499 BG
 BR- NA, BZ – NA,



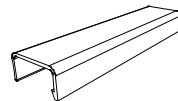
V360 – Panel Cap
 Order: part # 16222999 – Beige-150"



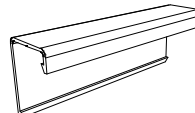
V770* – Stationary and
 Sidelite Leveling Block
 NA



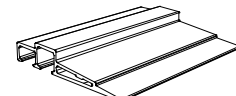
A732 – Active
 Astragal



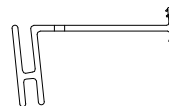
A733 – Inactive Astragal
 Cladding (Multi-Point)



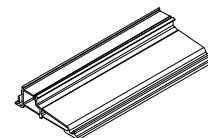
A721 – Inactive Astragal
 Cladding (non Multi-Point)



F252* – Ultrex Sill
 No longer available



V027 – Sill Leveling Block
 (Transom)
 Pre-2012



F256 – Ultrex Sill,
 4 9/16" Jamb
 Pre-2012

TO ORDER REPLACEMENT PARTS

When ordering replacement parts specify:

1. profile number;
2. size (call number or rough opening);
3. length;
4. handing;
5. finish (where applicable).

ORDERING REPLACEMENT PANELS FOR THE WOOD AND CLAD OUTSWING FRENCH DOOR

*Wood Ultimate Outswing French Door 1989 – 1/17/00.
 Clad Outswing French Door 1990 – 1/17/00.*

To order replacement panels specify:

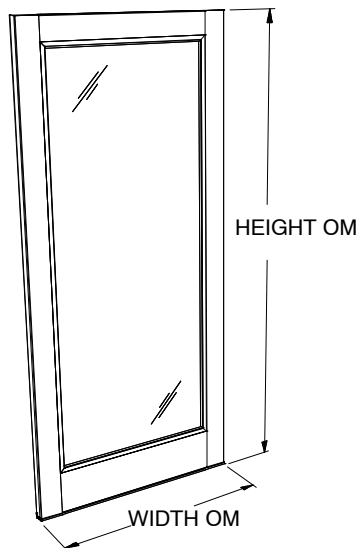
1. Wood or Clad;
2. size (call number or OM of panel);
3. active, inactive or stationary;
 - a. specify bore or no bore
4. handing;
5. glazing;
6. finish.

CLAD AND WOOD OUTSWING FRENCH DOOR (PRE 2000)

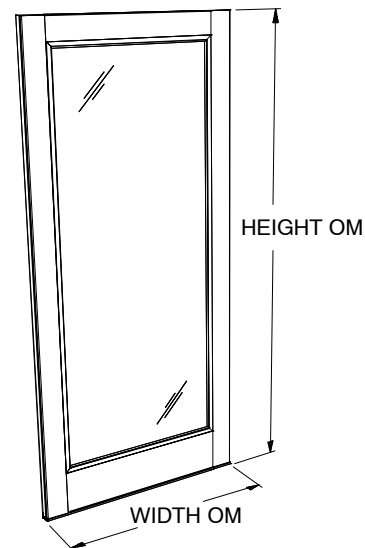
CN	Panel OSM		Panel DLO	
	Width	Height	Width	Height
2068 / 4068	24"	80"	14 1/2"	67 1/8"
2668 / 5068	30"	80"	20 1/2"	67 1/8"
2868 / 5468	32"	80"	22 1/2"	67 1/8"
3068 / 6068	36"	80"	26 1/2"	67 1/8"
2665	27 5/8"	76 5/16"	18 1/8"	63 7/16"
3065	33 5/8"	76 5/16"	24 1/8"	63 7/16"
7/0 Height		84"		67 1/8"
8/0 Height		96"		80 7/8"

Units will have:

- 4 3/4" top rail and stiles. Bottom rail height: 6/5 and 6/8 = 8 1/8"; 7/0 = 12 1/8"; and 8/0 = 10 3/8".
- 4" x 4" butt hinges. 6/5, 6/8, and 7/0 heights will have 4 hinges. 8/0 height will have 5 hinges.



Wood Ultimate Outswing Active Panel Exterior View



Clad Ultimate Outswing Active Panel Exterior View

Active panels include: sweep, route for hinges and panel cap. Clad Ultimate Outswing panels also include panel drip.

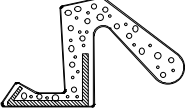
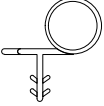
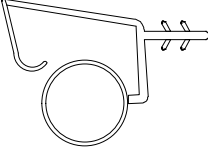


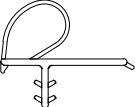

Inactive panels include: sweep, route for hinges, astragal, head and foot bolts and panel cap. Clad Ultimate Outswing panels also include panel drip.

Stationary panels include: leveling block and panel cap. Clad Ultimate Outswing panels also include panel drip.

OBSOLETE WEATHER STRIP**OUTSWING FRENCH DOORS***Wood Ultimate Outswing French Door 1989 – 1/17/00.**Clad Outswing French Door 1990 – 1/17/00.*

When ordering replacement weather strip specify:

1. quantity;
2. length;
3. part number;
4. description.

ILLUSTRATION <i>NOT TO SCALE</i>	DESCRIPTION	LENGTH	PART NUMBER
	Foam Weather Strip, Frame V650 Color: Beige Wood doors only	144"	02100972
	Bulb Weather Strip, Transom Bottom Rail V192 Color: Beige	192"	15900118
	Leaf Bulb Weather Strip, Inactive Astragal V501 Color: Beige Clad outswing doors only	98"	NA
	Bulb Weather Strip, Active Astragal V910 Color: Beige Clad Outswing doors only	Lineal Foot	15610999
	Pile Weather Strip, Sill Adhesive backed Color: Beige 13/16" x 13/32" x 1 15/16"		NA
	Offset Bulb Weather Strip, Parting Stop, Frame, Mull Casing, Transom and Astragal V796 Color: Beige	189 11/16"	15173298
	Weather Strip, Stile V020 Color: Beige	95 9/16"	11197980

OBSOLETE WEATHER STRIP

OUTSWING FRENCH DOORS

Ultimate Outswing – Pre 2012

When ordering replacement weather strip specify:

1. quantity;
2. length;
3. part number;
4. description.



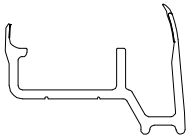
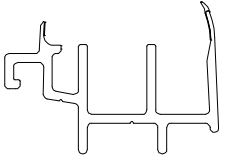
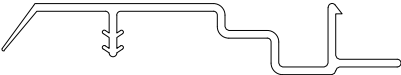

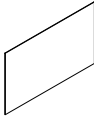
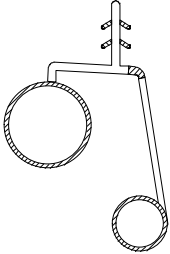
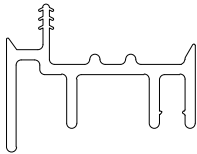
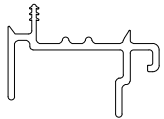
ILLUSTRATION <i>NOT TO SCALE</i>	DESCRIPTION	LENGTH	COLOR	PART NUMBER
	Weather Strip, Sill V776	87 11/16" 164 7/8" 164 7/8"	BG BG BK	11197276 11197296 11197297
	Dust Block, Astragal or Panel 1 3/8" x 1/4" x 3/8"			10500049
	Sweep, Active and Inactive Panel V2428 <i>For IZ4 UOFD post 6/30/2015</i>	70 1/2" 70 1/2"	BG BK	11182470 11182471
	Sweep, Stationary Panel V2429 <i>For IZ4 UOFD post 6/30/2015</i>	70 1/2" 70 1/2"	BG BK	11181970 11181971
	Weather Strip, Frame – Pre 2012 V017 lineal	164 7/8" 200"	BG BK	11197596 11197598
	Corner Gasket Adhesive backed		BK	15600023
	Butyl Tape 3" Width	Per Roll	BK	11406302

ILLUSTRATION NOT TO SCALE	DESCRIPTION	LENGTH / COLOR		PART NUMBER
	Hinged Dual Bulb Weather Strip, Head Jamb and Jamb V193 Color: Beige Clad Outswing doors only	78" 110"	NA	
	Sweep, Active and Inactive Panel V779 NOTE: Std UOFD pre 2012 IZ4 UOFD pre 6/30/2015 Replaced by V2428 for IZ4, post 6/30/15. FSO Only			
	Sweep, Stationary Panel V778 NOTE: Std UOFD pre 2012 IZ4 UOFD pre 6/30/2015 Replaced by V2428 for IZ4, post 6/30/15. FSO Only	CN 3/0 CN 3/0 CN 3/6 150" 150"	BG BK BG BG BK	11197330 11197331 11197336 11197399 11197398

ORDERING ENERGY PANELS FOR SINGLE GLAZED WOOD OUTSWING FRENCH DOORS*Wood Outswing French Door 1989 – 1/17/00.*

If you are replacing an existing energy panel, determine the outside measurement of the existing energy panel. Find the sizes that correspond to the width and height indicated on the following chart. Energy panels are available for the single glazed Wood Ultimate Outswing French Doors. Aluminum surrounds are available in bronze or stone white.

When ordering energy panels specify:

1. size; If there is no existing EP from which to obtain the OM of the panel, determine the size of the EP by using the conversion chart below. The daylight opening is the measurement of the visible glass.
2. color of surround;
3. glass type;

Wood Ultimate Outswing French Door				
Wood Ultimate Outswing French Doors manufactured 1989 – 1/17/00				
Daylight Opening to OM of EP				
Daylight Width + 1" = OM Width of EP				
Daylight Height + 1" = OM Height of EP				
WIDTH			HEIGHT	
SIZE	(6-5 ht.)	OM-WIDTH	SIZE	OM-HEIGHT
CN 1-6	(6-5 ht.)	9 1/2"	CN 6-5	64 1/2"
CN 2-6	(6-5 ht.)	19 1/4"		
CN 3-0	(6-5 ht.)	25 1/4"		
CN 1-4		11 13/32"	CN 6-8	68 1/8"
CN 2-0		15 1/2"	CN 7-0	68 1/8"
CN 2-6		21 1/2"	CN 8-0	81 7/8"
CN 2-8		23 1/2"		
CN 3-0		27 1/2"		