

WOOD AND CLAD OUTSWING BI-FOLD DOOR

Table of Contents

NOTICE: Marvin Windows and Doors discontinued the sale of 1 3/4" panel wood and clad Bi-fold doors effective April 24, 2017. The 2 1/4" panel Clad Ultimate Bi-fold Door (CMOBFD) is the current platform for this door. Marvin will continue to provide full support with a complete line of hardware and replacement parts as specified by the Marvin warranty.

| | PAGE |
|---|-------------|
| History | 2 |
| Part Identification – Wood Outswing Bi-Fold Door Head Jamb with Sill Options | 3 |
| Part Identification – Wood Outswing Bi-Fold Door 2, 3 and 5 Panel Jamb Detail | 4 |
| Part Identification – Clad Outswing Bi-Fold Door Head Jamb with Sill Options | 5 |
| Part Identification – Clad Outswing Bi-Fold Door 2, 3 and 5 Panel Jamb Detail | 6 |
| Bi-Fold Door Configurations | 7 |
| Parts – Hardware Configurations | 8 |
| Parts – Bi-Fold Doors | 10 |
| Weather Strip and Vinyl | 17 |
| Replacement Wood Parts | 18 |
| Replacement Vinyl, Aluminum or Fiberglass Parts | 19 |
| Panel Replacement | 20 |
| Energy Panels and Parts | 21 |

ATTENTION:

- Specification and technical data are subject to change without notice.
- Numbers listed in parentheses () are metric equivalents in millimeters rounded to the nearest whole number.

HISTORY

| PRODUCED | UNIT TYPE | FEATURES OR CHANGES | DISCONTINUED |
|----------|-------------------------------------|---|--------------|
| 2006 | Clad Outswing Bi-Fold Door | Unit features: 3/4" insulating glass, 5 1/2" jambs, CN68, 70 and 80 heights. Up to 8 panel configurations. E3 folding door hardware. | Present |
| 2006 | Wood Outswing Bi-Fold Door | Unit features: 3/4" insulating glass, 6 9/16" jambs, CN68, 70 and 80 heights. Up to 8 panel configurations. E3 folding door hardware. | Present |
| 2014 | Wood and Clad Outswing Bi-Fold Door | 06/23/2014 – Added Contemporary panel and Contemporary handle options, retro sizes and beige weather strip options. | Present |
| 2014 | Wood and Clad Outswing Bi-Fold Door | 10/27/2014 – Introduced Ogee as the new default interior profile. | Present |

**WOOD OUTSWING BI-FOLD DOOR
 HEAD JAMB WITH SILL OPTIONS**

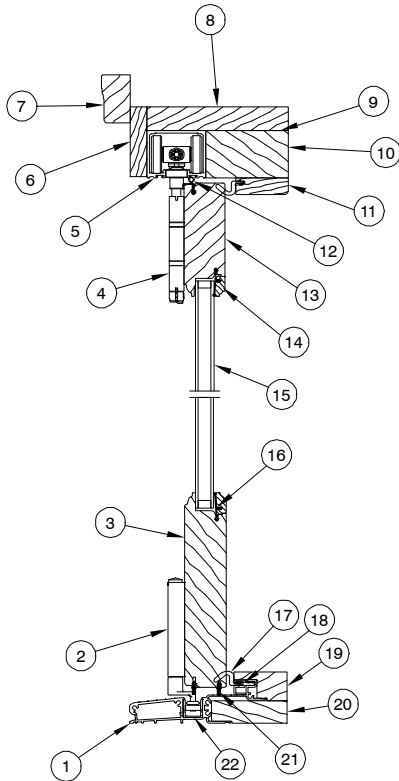

**Head Jamb
 w/Standard Sill And
 Traditional Bottom Rail**

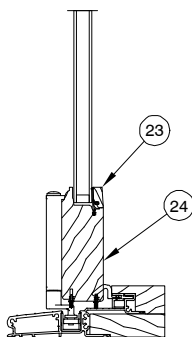

**Standard Sill And
 Contemporary Bottom Rail**

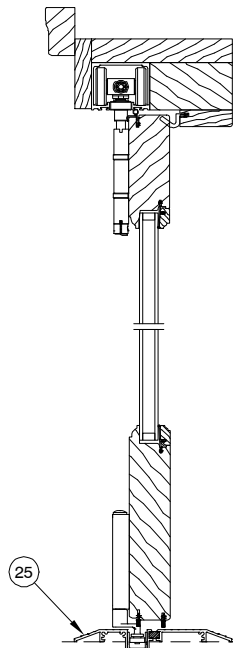

**Head Jamb
 w/ ADA Sill**

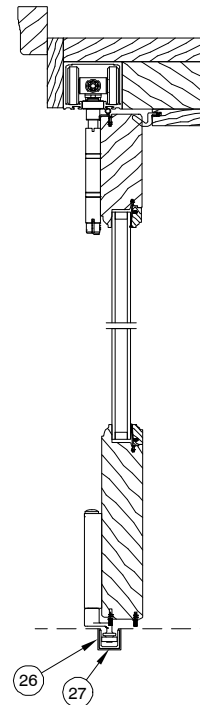

**Head Jamb
 w/ Floor Channel Sill**

1. Bi-Fold sill, 6 9/16"
2. Panel Guide
3. Bottom Rail – Traditional
4. Panel Carrier
5. Head Jamb Track
6. Head Jamb Track Cover
7. Wood BMC
8. Head Jamb/Jamb
9. Connecting Barb
10. Head Jamb Support
11. Head Jamb/Jamb Stop
12. Panel Cover Weather Strip
13. Top Rail/Stile
14. Glazing Cap
15. Insulating Glass
16. Glazing Bead
17. Frame Weather Strip
18. Retainer Clip
19. Sill Nose
20. Sill Support Base
21. Bottom Rail Weather Strip
22. Channel Liner
23. Glazing Cap – Contemporary
24. Bottom Rail – 4 3/4" Contemporary
25. ADA Sill
26. Floor Channel
27. Floor Channel Liner

NOTE: Not to scale; specifications subject to change without notice.

**WOOD OUTSWING BI-FOLD DOOR
 JAMB DETAIL**

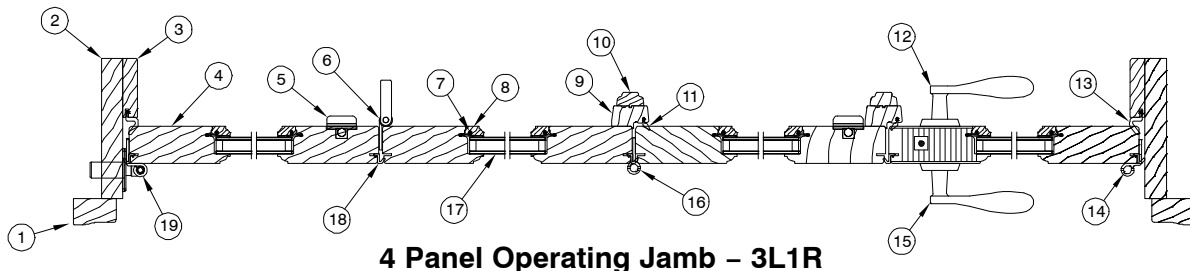

4 Panel Operating Jamb – 3L1R

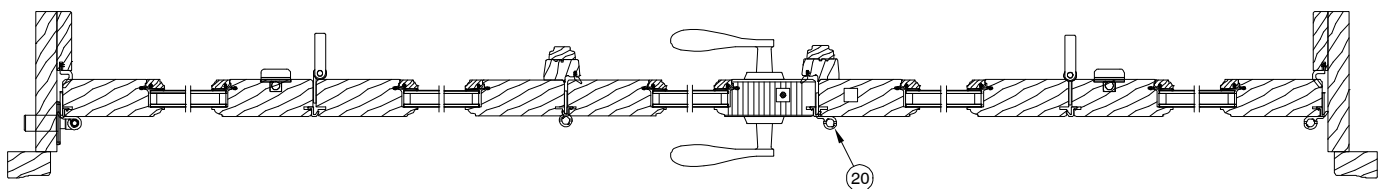

5 Panel Operating Jamb – 3L2R

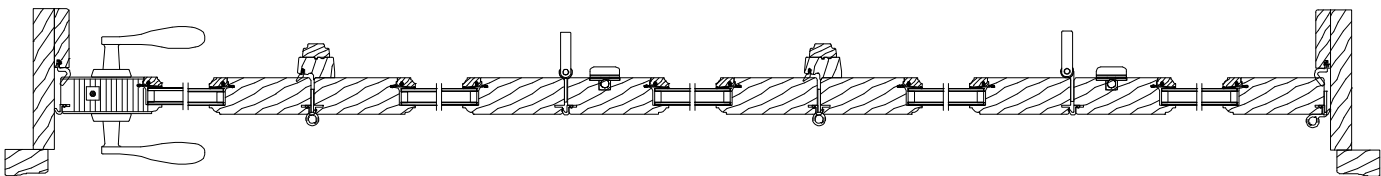

5 Panel Operating Jamb – 5R

NOTE: For more configurations see Marvin Architectural Detail Manual.

- | | |
|----------------------------|---------------------------------|
| 1. Wood BMC | 14. End Pivots (Top and Bottom) |
| 2. Jamb/Head Jamb | 15. Exterior Handle |
| 3. Jamb/Head Stop | 16. Intermediate Carrier Set |
| 4. Stile/Top Rail | 17. Insulating Glass |
| 5. Drop Bolt | 18. Panel Weather Strip |
| 6. Half Offset Hinge Set | 19. Wall Pivot Hinge (Middle) |
| 7. Glazing Bead | 20. Left Carrier Set |
| 8. Glazing Cap | |
| 9. Mull Casing Base | |
| 10. Mull Casing Cover | |
| 11. Astragal Weather Strip | |
| 12. Interior Handle | |
| 13. Frame Weather Strip | |

NOTE: Not to scale; specifications subject to change without notice.

**CLAD OUTSWING BI-FOLD DOOR
 HEAD JAMB WITH SILL OPTIONS**

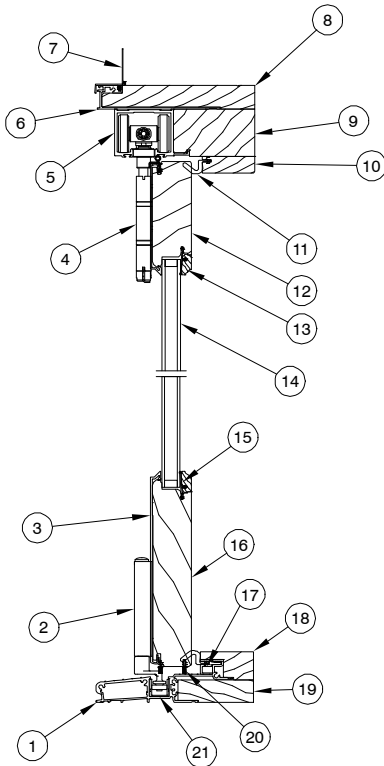

**Head Jamb
 w/Standard Sill And
 Traditional Bottom Rail**

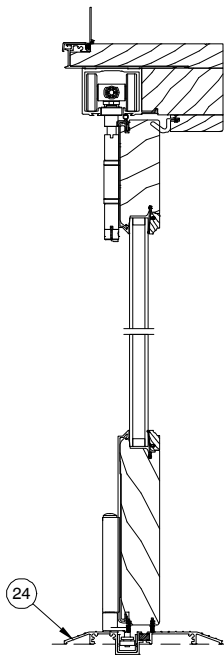

**Head Jamb
 w/ ADA Sill**

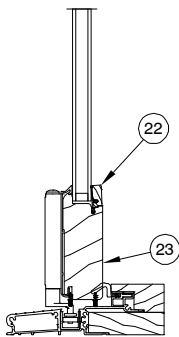

**Standard Sill And
 Contemporary Bottom Rail**

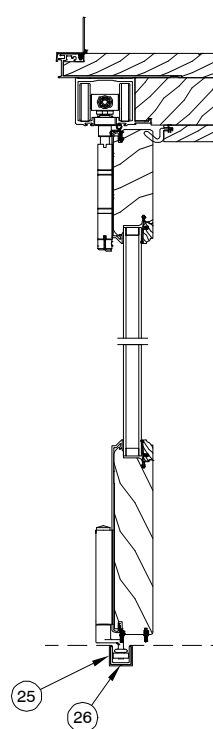

**Head Jamb
 w/ Floor Channel Sill**

1. Bi-Fold sill, 6 9/16"
2. Panel Guide
3. Bottom Rail Cladding
4. Top Carrier
5. Head Jamb Track
6. Head Jamb/Jamb Cladding
7. Drip Cap/Nailing Fin
8. Head Jamb/Jamb
9. Head Jamb Support
10. Head Jamb/Jamb Stop
11. Frame Weather Strip
12. Top Rail/Stile
13. Glazing Cap
14. Insulating Glass
15. Glazing Bead
16. Bottom Rail Wood - Traditional
17. Retainer Clip
18. Sill Nose
19. Sill Support Base
20. Bottom Rail Weather Strip
21. Channel Liner
22. Glazing Cap - Contemporary
23. Bottom Rail - 4 3/4" Contemporary
24. ADA Sill
25. Floor Channel
26. Floor Channel Liner

NOTE: Not to scale; specifications subject to change without notice.

**CLAD OUTSWING BI-FOLD DOOR
 JAMB DETAIL**

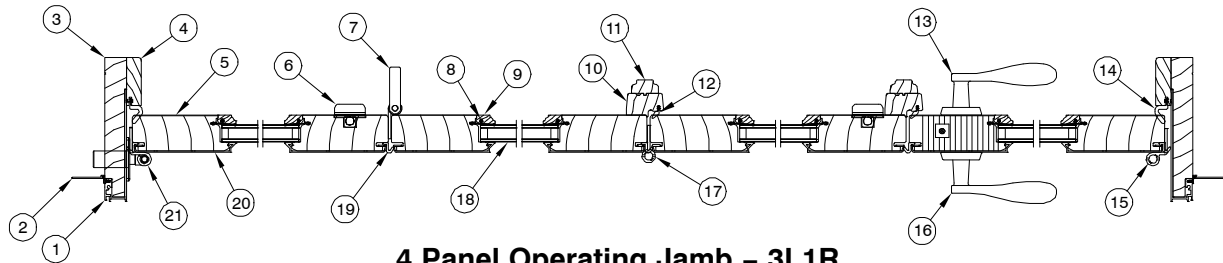

4 Panel Operating Jamb – 3L1R

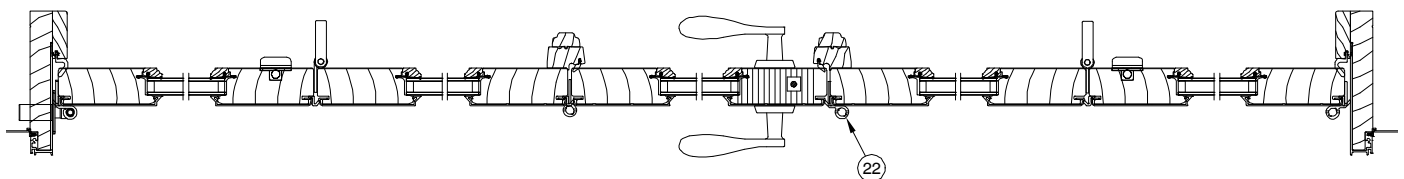

5 Panel Operating Jamb – 3L2R

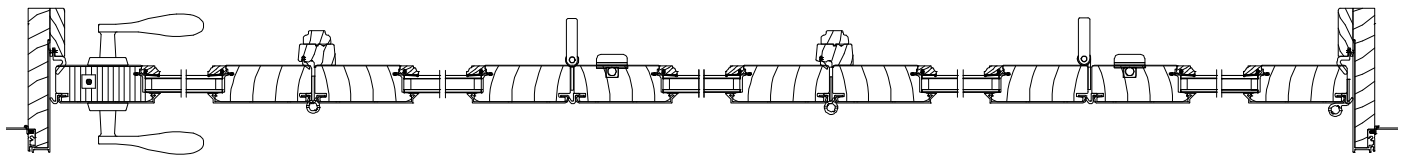

5 Panel Operating Jamb – 5R

NOTE: For more configurations see Marvin Architectural Detail Manual.

- | | |
|--------------------------|------------------------------|
| 1. Jamb/Head Jamb | 12. Astragal Weather Strip |
| 2. Nailing Fin | 13. Interior Handle |
| 3. Jamb/Head Jamb Stop | 14. Frame Weather Strip |
| 4. Jamb/Head Jamb Stop | 15. End Pivot (Top & Bottom) |
| 5. Stile Wood | 16. Exterior Handle |
| 6. Drop Bolt | 17. Intermediate Carrier Set |
| 7. Half Offset Hinge Set | 18. Insulating Glass |
| 8. Glazing Bead | 19. Panel Weather Strip |
| 9. Glazing Cap | 20. Stile Cladding |
| 10. Astragal Base | 21. Wall Pivot (Middle) |
| 11. Astragal Cover | 22. Left Carrier Set |

NOTE: Not to scale; specifications subject to change without notice.

OUTSWING BI-FOLD DOOR – CONFIGURATIONS

Not Accessible from Exterior

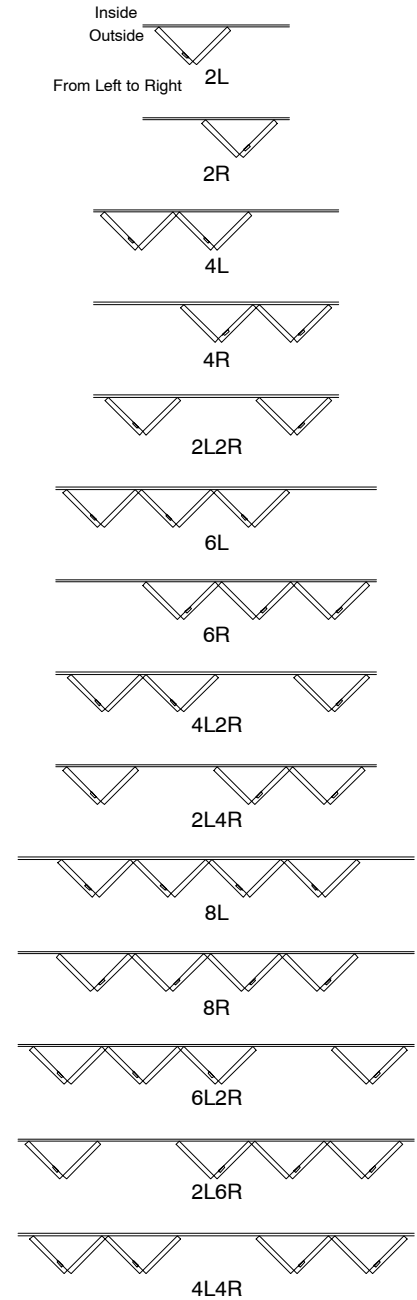
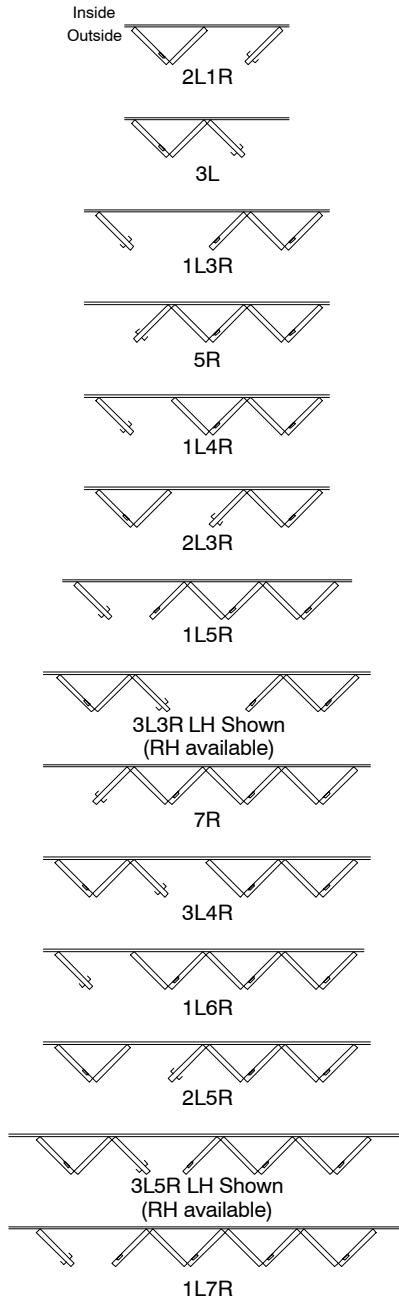
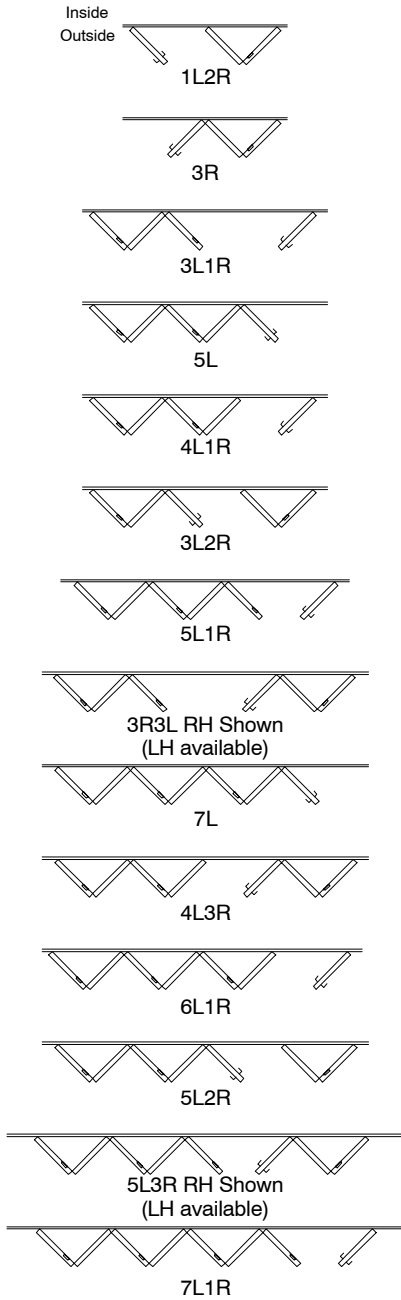

NOTE: For replacements on these configurations see charts on the following pages.

PARTS – HARDWARE CONFIGURATIONS

| Finsh | Part Numbers | | | | | | |
|-----------------|--------------|-------------------|------------------|-----------------|-------------------------|--------------|--------------------------|
| PVD Bronze | 11102415 | 11102423 | 11102417 | 11102413 | 11102411 | 11102421 | 11102419 |
| Stainless Steel | 11102416 | 11102424 | 11102418 | 11102414 | 11102412 | 11102422 | 11102420 |
| PVD Brass | 10148303 | 10148304 | 10148308 | 10148309 | 10148307 | 10148306 | 10148305 |
| | Pivot | Wall Pivot Set | Right Carrier | Left Carrier | Intermediate Carrier | Hinge Set | Half Offset Hinge Set |
| Code | Quantity | | | | | | |
| 2L* | 1 | 1 | 1 | | | 1 | |
| 2R* | 1 | 1 | | 1 | | 1 | |
| 2L1R | 2 | 2 | 1 | | | 1 | |
| 1L2R | 2 | 2 | | 1 | | 1 | |
| 3L | 1 | 1 | | | 1 | | 1 |
| 3R | 1 | 1 | | | 1 | | 1 |
| 3L1R | 2 | 2 | | | 1 | | 1 |
| 1L3R | 2 | 2 | | | 1 | | 1 |
| 4L* | 1 | 1 | 1 | | 1 | | 2 |
| 2L2R* | 2 | 2 | 1 | 1 | | 2 | |
| 4R* | 1 | 1 | | 1 | 1 | | 2 |
| 4L1R | 2 | 2 | 1 | | 1 | | 2 |
| 1L4R | 2 | 2 | | 1 | 1 | | 2 |
| 3L2R | 2 | 2 | | 1 | 1 | 1 | 1 |
| 2L3R | 2 | 2 | 1 | | 1 | 1 | 1 |
| 5L | 1 | 1 | | | 2 | 1 | 1 |
| 5R | 1 | 1 | | | 2 | 1 | 1 |
| 6L* | 1 | 1 | 1 | | 2 | 1 | 2 |
| 6R* | 1 | 1 | | 1 | 2 | 1 | 2 |
| 2L4R* | 2 | 2 | 1 | 1 | 1 | 1 | 2 |
| 4L2R* | 2 | 2 | 1 | 1 | 1 | 1 | 2 |
| 5L1R | 2 | 2 | | | 2 | 1 | 1 |
| 1L5R | 2 | 2 | | | 2 | 1 | 1 |
| 3L3R | 2 | 2 | | | 2 | | 2 |
| 7L | 1 | 1 | | | 3 | 2 | 1 |
| 3L4R | 2 | 2 | | 1 | 2 | | 3 |
| 7R | 1 | 1 | | | 3 | 2 | 1 |
| 4L3R | 2 | 2 | 1 | | 2 | | 3 |
| 5L2R | 2 | 2 | | 1 | 2 | 2 | 1 |
| 2L5R | 2 | 2 | 1 | | 2 | 2 | 1 |
| 6L1R | 2 | 2 | | 1 | 2 | 1 | 2 |
| 1L6R | 2 | 2 | 1 | | 2 | 1 | 2 |
| 5L3R | 2 | 2 | | | 3 | 1 | 2 |
| 3L5R | 2 | 2 | | | 3 | 1 | 2 |
| 6L2R* | 2 | 2 | 1 | 1 | 2 | 2 | 2 |
| 2L6R* | 2 | 2 | 1 | 1 | 2 | 2 | 2 |
| 7L1R | 2 | 2 | | | 3 | 2 | 1 |
| 1L7R | 2 | 2 | | | 3 | 2 | 1 |
| 8R* | 1 | 1 | | 1 | 3 | 2 | 2 |
| 8L* | 1 | 1 | 1 | | 3 | 2 | 2 |
| 4L4R* | 2 | 2 | 1 | 1 | 2 | | 4 |

* Not accessible from the exterior.

PARTS – HARDWARE CONFIGURATIONS

| Finsh | Part Numbers | | | | | | |
|-------|--|----------------------------|----------------------------------|----------------------------------|----------------------------------|-------------|----------------------------------|
| | PVD Bronze Stainless Steel PVD Brass | 11102402 BZ 11102403 SA | 11102406 11102407 11102120 | 11102406 11102407 11102120 | 11102409 11102410 11102121 | 05700130 | 10148300 10148302 10148301 |
| | Drop Bolt Cup | Lower Drop Bolt 8 | Upper Drop Bolt 8 <= CN70 | Upper Drop Bolt 16 > CN70 | Multi Lock – box | Strike Jamb | Strike Panel |
| Code | Quantity | | | | | | |
| 2L* | 2 | 1 | 1 | 1 | | | |
| 2R* | 2 | 1 | 1 | 1 | | | |
| 2L1R | 2 | 1 | 1 | 1 | 1 | | 1 |
| 1L2R | 2 | 1 | 1 | 1 | 1 | | 1 |
| 3L | 2 | 1 | 1 | 1 | 1 | 1 | |
| 3R | 2 | 1 | 1 | 1 | 1 | 1 | |
| 3L1R | 4 | 2 | 2 | 2 | 1 | | 1 |
| 1L3R | 4 | 2 | 2 | 2 | 1 | | 1 |
| 4L* | 4 | 2 | 2 | 2 | | | |
| 2L2R* | 4 | 2 | 2 | 2 | | | |
| 4R* | 4 | 2 | 2 | 2 | | | |
| 4L1R | 4 | 2 | 2 | 2 | 1 | | 1 |
| 1L4R | 4 | 2 | 2 | 2 | 1 | | 1 |
| 3L2R | 4 | 2 | 2 | 2 | 1 | | 1 |
| 2L3R | 4 | 2 | 2 | 2 | 1 | | 1 |
| 5L | 4 | 2 | 2 | 2 | 1 | 1 | |
| 5R | 4 | 2 | 2 | 2 | 1 | 1 | |
| 6L* | 6 | 3 | 3 | 3 | | | |
| 6R* | 6 | 3 | 3 | 3 | | | |
| 2L4R* | 6 | 3 | 3 | 3 | | | |
| 4L2R* | 6 | 3 | 3 | 3 | | | |
| 5L1R | 6 | 3 | 3 | 3 | 1 | | 1 |
| 1L5R | 6 | 3 | 3 | 3 | 1 | | 1 |
| 3L3R | 6 | 3 | 3 | 3 | 1 | | 1 |
| 7L | 6 | 3 | 3 | 3 | 1 | 1 | |
| 3L4R | 6 | 3 | 3 | 3 | 1 | | 1 |
| 7R | 6 | 3 | 3 | 3 | 1 | 1 | |
| 4L3R | 6 | 3 | 3 | 3 | 1 | | 1 |
| 5L2R | 6 | 3 | 3 | 3 | 1 | | 1 |
| 2L5R | 6 | 3 | 3 | 3 | 1 | | 1 |
| 6L1R | 6 | 3 | 3 | 3 | 1 | | 1 |
| 1L6R | 6 | 3 | 3 | 3 | 1 | | 1 |
| 5L3R | 8 | 4 | 4 | 4 | 1 | | 1 |
| 3L5R | 8 | 4 | 4 | 4 | 1 | | 1 |
| 6L2R* | 8 | 4 | 4 | 4 | 1 | | 1 |
| 2L6R* | 8 | 4 | 4 | 4 | 1 | | 1 |
| 7L1R | 8 | 4 | 4 | 4 | 1 | | 1 |
| 1L7R | 8 | 4 | 4 | 4 | 1 | | 1 |
| 8R* | 8 | 4 | 4 | 4 | | | |
| 8L* | 8 | 4 | 4 | 4 | | | |
| 4L4R* | 8 | 4 | 4 | 4 | | | |

* Not accessible from the exterior.

NOTE: Default upper drop bolt length 8" (203) for heights up to CN7/0, 16" (406) for heights over CN 7/0.



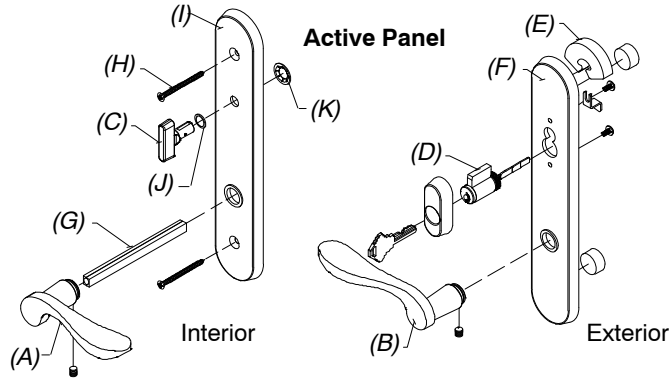

When ordering replacement parts specify:

1. type of unit;
2. part number;
3. description.

ILLUSTRATIONS (not to scale)

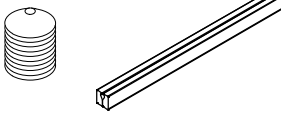

| | | |
|---|---|---|
| <p>Handle Assembly, Active Panel Mortise lock and Multi-point lock systems (Schlage "C" keyway) Includes: 1 - Interior lever (A) with 00142006 spindle, escutcheon plate and hardware 1 - Exterior lever (B) with escutcheon plate and hardware 1 - Thumb turn (C) with hardware 1 - Keyed cylinder (D) with housing and hardware 1 - Exterior escutcheon plate gasket (E) 1 - Exterior escutcheon plate (F) 1 - Two piece spindle (G) 2 - #10-32 x 2 1/8" Phillips ovalhead machine screws (H) 1 - Interior escutcheon plate (I) 1 - Thumb turn washer (J) 1 - Thumb turn push nut (K) 2 - Keys</p> | <p>Satin Taupe Antique Brass White Satin Chrome Oil Rubbed Bronze ORBZ PVD Brass PVD Satin Nickel PVD Dark Bronze Polished Chrome Matte Black</p> | <p>10830304 10830306 10830310 10830302 10148111 10830300 10830324 10830421 10830330 10830308 10830450</p> |
| <p>Thumb Turn (C) NOTE: For each thumb turn, order one thumb turn washer -00143045 (J) and one thumb turn push nut 00143010 (K).</p> | <p>Satin Taupe Antique Brass White Oil Rubbed Bronze ORBZ PVD Brass PVD Satin Nickel PVD Satin Chrome Dark Bronze</p> | <p>00142061 00142055 00142058 00142062 10148428 00142054 00142063 00142064 10148426</p> |

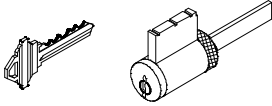
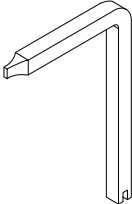
| ILLUSTRATION NOT TO SCALE | DESCRIPTION | OPER./COLOR | PART NO. |
|---|---|--|--|
|  | Lug seals | | 00142046 |
|  | #10-32 x 2 1/8" Phillips ovalhead machine screws | Satin Taupe Antique Brass White Satin Chrome Oil Rubbed Bronze ORBZ PVD Brass PVD Satin Nickel PVD Dark Bronze | 11800616 00143038 00143036 10840031 10840032 11800160 11800615 NA 11800654 |
|  | Spindle Kit (Truth & Ashland) <i>Includes:</i> 1 – 2 piece. spindle, 4 3/8" 2 – Set screws | | 02100942 |
|  | Lever Bushing, Swinging Handle Set – Traditional | Clear Gray Gold Natural Black | 02062201 10148448 10148447 02062202 10148020 |
|  | Key Cylinder, Lock (Schlage "C" keyway) For service replacement only. <i>NOTE: For Keyed Alike orders, use program C87P2.</i> <i>BS, ORBZ PVD, TP, WH, AB=Brass Face</i> <i>All other Marvin finishes=Chrome Face</i> | Brass Face Chrome Face | 10830211 10830208 |
|  | Construction Handle | | 10830451 |

NOTE: Dark Bronze screws are used with Antique Brass and Oil Rubbed Bronze PVD

When ordering replacement parts specify:





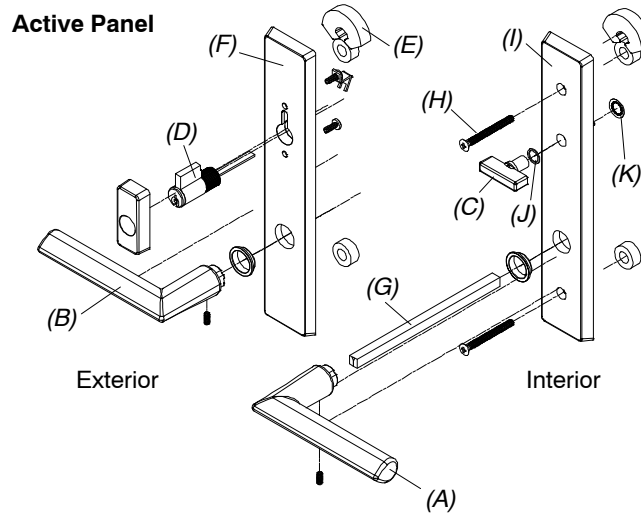

1. type of unit;
2. part number;
3. description.

ILLUSTRATIONS (not to scale)

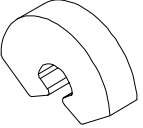

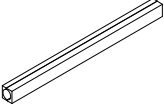
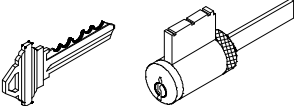
| | | |
|---|--|---|
| <p>Handle Assembly, Active Panel Mortise lock and Multi-point lock systems (Schlage "C" keyway) Includes: 1 - Interior lever (A) with 10148414 spindle, escutcheon plate and hardware 1 - Exterior lever (B) with escutcheon plate and hardware 1 - Thumb turn (C) with hardware 1 - Keyed cylinder (D) with housing and hardware 1 - Exterior escutcheon plate gasket (E) 1 - Exterior escutcheon plate (F) 1 - Two piece spindle (G) 2 - M5 x 55mm Phillips ovalhead machine screws (H) 1 - Interior escutcheon plate (I) 1 - Thumb turn washer (J) 1 - Thumb turn push nut (K) 2 - Keys</p> | <p>TP ORBZ PVD SN PVD DK BZ</p> | <p>11102150 11102151 11102152 11102156</p> |
| <p>Thumb Turn (C) NOTE: For each thumb turn, order one thumb turn washer -10148423 (J) and one thumb turn push nut 10148424(K).</p> | <p>TP ORBZ PVD SN PVD DK BZ</p> | <p>10148425 10148428 10148427 10148426</p> |

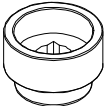
PARTS – CONTEMPORARY HANDLE

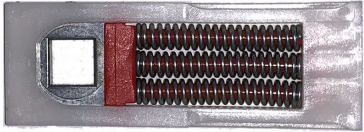
| ILLUSTRATION NOT TO SCALE | DESCRIPTION | OPER./COLOR | PART NO. |
|---|---|---|--|
|  | Gasket Post | | 10148404 |
|  | Gasket – Top Backplate | | 10148405 |
|  | M5 x 55mm Phillips ovalhead machine screw | Satin Taupe Dark Bronze ORB PVD Satin Nickel PVD | 10148400 10148401 10148402 10148403 |
|  | Spindle Kit (HOPPE) <i>Includes:</i> 1 – 2 piece. spindle, 4 3/8" 2 – Set screws | | 10148414 |
|  | Key Cylinder, Lock (Schlage “C” keyway) For service replacement only. <i>NOTE: For Keyed Alike orders, use program C87P2.</i> <i>BS, ORBZ PVD, TP, WH, AB=Brass Face</i> <i>All other Marvin finishes=Chrome Face</i> | Brass Face Chrome Face | 10830211 10830208 |
|  | Set Screw for Handle Assembly See Spindle kit | | NA |
|  | Lever Bushing, Swinging Handle Set – Contemporary | Gray Natural Black | 10148448 02062202 10148020 |
|  | 3/4" Handle Extension Requires 3/4" Spindle Extension | Satin Taupe Dark Bronze | 10148419 10148420 |
|  | 3/4" Spindle Extension (HOPPE) | | 10148415 |
|  | Spring Cartridge, Swinging Handle Set – Contemporary | | 10830452 |

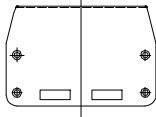
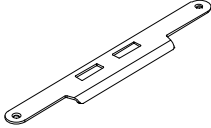
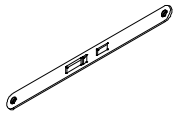
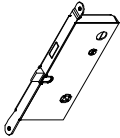
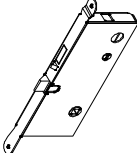
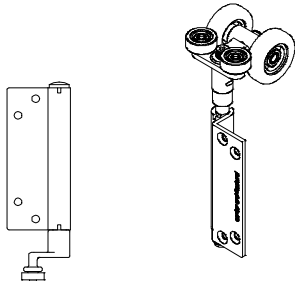
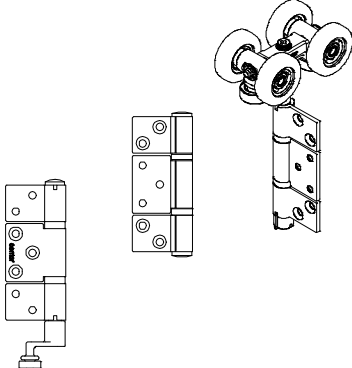
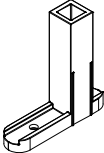
| ILLUSTRATION NOT TO SCALE | DESCRIPTION | OPER./COLOR | PART NO. |
|---|---|---|--|
|  | <p>Strike Plate, Jamb Includes: 1 - Jamb strike plate 4 - #8x1" Phillips flathead screws</p> | <p>Satin Chrome ORBZ PVD Brass PVD</p> | <p>10148302 10148300 10148301</p> |
|  | <p>Strike Plate, Panel - Includes: 1 - Panel strike plate 2 - #8x1" Phillips flathead screws (match finish of strike plate)</p> | <p>Stainless Steel Antique Brass ORBZ PVD Brass PVD</p> | <p>05700049 05700044 05700117 10148176</p> |
|  | <p>Cover Plate, Active Panel - Mortise Lock or Multi-Point Lock* 1/17/00 - Present (Amerock) Includes: 1 - Cover plate 2 - #8x1" Phillips flathead wood screws</p> | <p>Stainless Steel Antique Brass ORBZ PVD Brass PVD</p> | <p>05700306 05700307 05700308 10148179</p> |
|  | <p>Mortise Lock, Active Single-Point Lock (latch, dead bolt only) 1/17/00 - Present (Amerock) Includes: 2 - #8x3/4" Phillips flathead screws</p> | | <p>05700129</p> |
|  | <p>Mortise Lock, Active Multi-Point Lock (latch, dead bolt and head/foot shoot bolts) 1/17/00 - Present (Amerock) Includes: 2 - #8x3/4" Phillips flathead screws</p> | | <p>05700130</p> |
|  | <p>Carrier Set Includes: 1 - Top carrier 1 - Bottom guide 8 - #8x1 1/2" Phillips flathead screws</p> | <p>Stainless Steel Bronze PVD Brass PVD</p> | <p>Left 11102414 11102413 10148309 Right 11102418 11102417 10148308</p> |
|  | <p>Concealed Intermediate Carrier Set Includes: 1 - Top carrier 1 - Center hinge 1 - Bottom guide 21 - #8x1 1/2" Phillips flathead screws</p> | <p>Stainless Steel Bronze PVD Brass PVD</p> | <p>11102412 11102411 10148307</p> |
|  | <p>Shoot Bolt Guide Active Panels - w/Multi-Point (2 Shoot Bolt Guides are required) 1 - Shoot bolt guide (10815186) 1 - #8x1 1/2" Phillips panhead wood screw (11800766)</p> | | <p>10815199</p> |

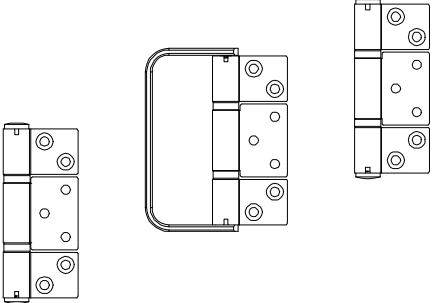
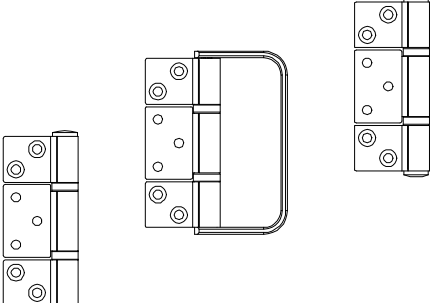
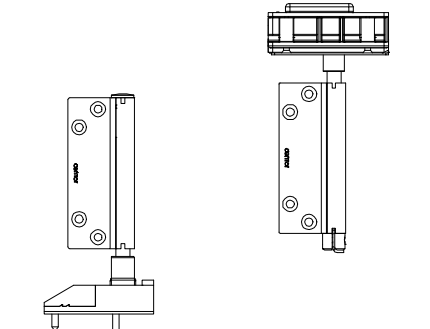
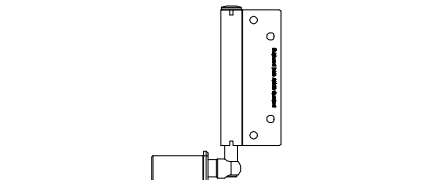
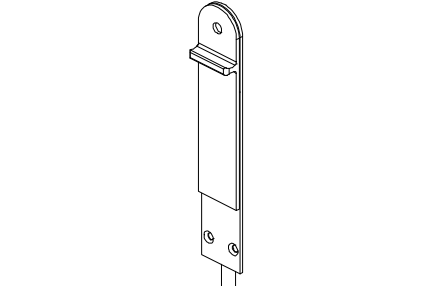
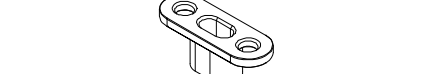
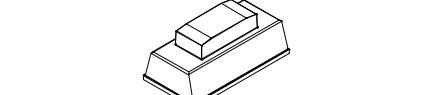

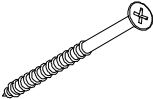
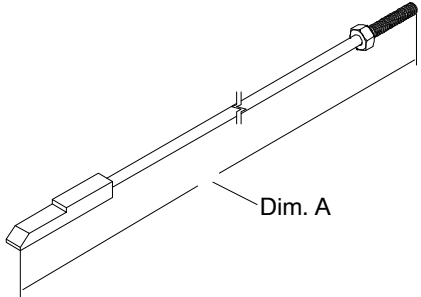
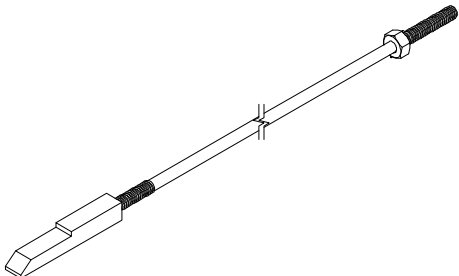
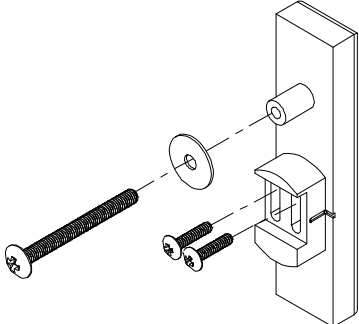



| ILLUSTRATION NOT TO SCALE | DESCRIPTION | OPER./COLOR | PART NO. |
|---|---|---|---|
|  | <p>Hinge Set Includes: 1 - Top hinge 1 - Center hinge with handle 1 - Bottom hinge 21 - #8x1 1/2" Phillips flathead screws</p> | <p>Stainless Steel Bronze PVD Brass PVD</p> | <p>11102422 11102421 10148306</p> |
|  | <p>Half Offset Hinge Set Includes: 1 - Top hinge 1 - Center hinge with handle 1 - Bottom hinge 21 - #8x1 1/2" Phillips flathead screws</p> | <p>Stainless Steel Bronze PVD Brass PVD</p> | <p>11102420 11102419 10148305</p> |
|  | <p>Concealed Pivot Hinge Set Includes: 1 - Top pivot 1 - Bottom pivot 8 - #8x1 1/2" Phillips flathead screws 1 - #2 Square drive 1 - Bottom Pivot Block w/#7x1" Pan head screw 1 - Hinge cap w/#7x1" Phillips flathead screws and #7x1" Pan head screw</p> | <p>Stainless Steel Bronze PVD Brass PVD</p> | <p>11102416 11102415 10148303</p> |
|  | <p>Wall Pivot Hinge Includes: 1 - Jamb cup 1 - Pivot rod 1 - Hinge 1 - #2 Square drive and strike bolt 6 - #8x1 1/2" Phillips flathead screws</p> | <p>Stainless Steel Bronze PVD Brass PVD</p> | <p>11102424 11102423 10148304</p> |
|  | <p>8" Drop Bolt Includes: 3 - #7x1 1/4" Phillips flathead screws</p> | <p>Brushed Metallic ORBZ Brass PVD</p> | <p>11102407 11102406 11102120</p> |
| | <p>16" Drop Bolt Includes: 3 - #7x1 1/4" Phillips flathead screws</p> | <p>Brushed Metallic ORBZ Brass PVD</p> | <p>11102410 11102409 11102121</p> |
| | <p>24" Drop Bolt Includes: 3 - #7x1 1/4" Phillips flathead screws</p> | <p>Brushed Metallic ORBZ Brass PVD</p> | <p>11102453 11102452 11102454</p> |
|  | <p>Drop Bolt Cup</p> | <p>Satin Bronze</p> | <p>11102403 11102402</p> |
|  | <p>Magnetic Door Catch Includes: 2 - Magnetic Door Catches</p> | <p>Black</p> | <p>11102443</p> |

| ILLUSTRATION NOT TO SCALE | DESCRIPTION | OPER./COLOR | PART NO. | | | | | | | | | | | | |
|---|---|--|---|-------------|----------|-----------|-----------|-----------|-----------|-----------|----------|------------------------|-----------------|------------------------|---|
|  | <p>Installation Screw Package; Strike Plate(s) at head jamb, or locking jamb</p> <p>#8 x 2 1/2" Flathead wood screw</p> <p>Package of 4 Package of 4 Package of 4</p> | <p>Stainless Steel Brass PVD Antique Brass</p> | <p>11882349 11882343 11882347</p> | | | | | | | | | | | | |
|  | <p>Locking Rod Assembly, Top – Multi-Point Lock</p> <p>Solid stainless steel rod with 1/4" – 20 threads</p> <p>NOTE: For special heights give dimension A.</p> <table border="1" data-bbox="667 751 992 961"> <thead> <tr> <th>Height</th> <th>Top Locking Rod Length</th> </tr> </thead> <tbody> <tr> <td>6/6 CN</td> <td>35 7/16"</td> </tr> <tr> <td>6/8 CN</td> <td>37 15/16"</td> </tr> <tr> <td>7/0 CN</td> <td>41 15/16"</td> </tr> <tr> <td>8/0 CN</td> <td>51 7/16"</td> </tr> <tr> <td>Lineal</td> <td>75 7/16"</td> </tr> </tbody> </table> | Height | Top Locking Rod Length | 6/6 CN | 35 7/16" | 6/8 CN | 37 15/16" | 7/0 CN | 41 15/16" | 8/0 CN | 51 7/16" | Lineal | 75 7/16" | <p>Stainless Steel</p> | <p>10815143 10815139 10815140 10815141 10815142</p> |
| Height | Top Locking Rod Length | | | | | | | | | | | | | | |
| 6/6 CN | 35 7/16" | | | | | | | | | | | | | | |
| 6/8 CN | 37 15/16" | | | | | | | | | | | | | | |
| 7/0 CN | 41 15/16" | | | | | | | | | | | | | | |
| 8/0 CN | 51 7/16" | | | | | | | | | | | | | | |
| Lineal | 75 7/16" | | | | | | | | | | | | | | |
|  | <p>Locking Rod Assembly, Bottom for Multi-Point Lock</p> <p>Solid stainless steel rod with 1/4" – 20 threads</p> <table border="1" data-bbox="667 1129 992 1304"> <thead> <tr> <th>Height</th> <th>Bottom Locking Rod Length</th> </tr> </thead> <tbody> <tr> <td>CN 6-6R ht*</td> <td>34 9/32"</td> </tr> <tr> <td>CN 6-8 ht</td> <td>34 9/32"</td> </tr> <tr> <td>CN 7-0 ht</td> <td>34 9/32"</td> </tr> <tr> <td>CN 8-0 ht</td> <td>34 9/32"</td> </tr> </tbody> </table> | Height | Bottom Locking Rod Length | CN 6-6R ht* | 34 9/32" | CN 6-8 ht | 34 9/32" | CN 7-0 ht | 34 9/32" | CN 8-0 ht | 34 9/32" | <p>Stainless Steel</p> | <p>10815138</p> | | |
| Height | Bottom Locking Rod Length | | | | | | | | | | | | | | |
| CN 6-6R ht* | 34 9/32" | | | | | | | | | | | | | | |
| CN 6-8 ht | 34 9/32" | | | | | | | | | | | | | | |
| CN 7-0 ht | 34 9/32" | | | | | | | | | | | | | | |
| CN 8-0 ht | 34 9/32" | | | | | | | | | | | | | | |
|  | <p>Construction Lock Assembly</p> <p>For Marvin residential swinging and sliding doors with standard locks.</p> <p><i>Includes:</i></p> <ul style="list-style-type: none"> 1 – Construction Lock Cover 1 – Construction Lock Hole Cover 1 – Washer 2 – #6-32 X 5/8" Phillips TH screws 1 – #10-32 X 2" Phillips TH screw | <p>Each 25/Box</p> | <p>18450200 18450198</p> | | | | | | | | | | | | |

WEATHER STRIP AND VINYL

When ordering replacement weather strip or vinyl parts, specify:

1. quantity;
2. length;
3. part number;
4. description.

| ILLUSTRATION <i>NOT TO SCALE</i> | DESCRIPTION | LENGTH | COLOR | PART NUMBER |
|---|---|--|------------------|--|
|  | Weather Strip, Panel Cover V018 | 150" 150" | BG BK | 11197799 11197798 |
|  | Weather Strip, Frame V1910 | 99" 144" 192" 99" 144" 192" | BG BZ | 11195304 11195305 11195306 11195300 11195302 11195301 |
|  | Weather Strip, Pile V1911 | Lineal | GY | 11195400 |
|  | Weather Strip, Astragal V1138 | Lineal | BG BK | 15910499 15910799 |
|  | Weather Strip, Panel V1897 | Lineal | BG BZ | 11195201 11195200 |
|  | Dust Block, Panel V1962 | Lineal | GY | 11195303 |
|  | Sill Gasket | | BK | 11102404 |

REPLACEMENT WOOD PARTS

OUTSWING BI-FOLD DOOR

| | Wood | Clad |
|-------------------|--------|--------|
| Jamb Stop | W10142 | W10142 |
| Mull Casing Base | W1455 | W1455 |
| Mull Casing Cover | W7554 | W7554 |

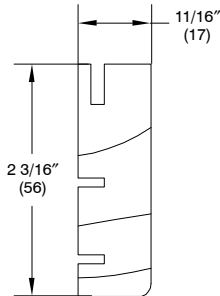

W10142 – Jamb Stop

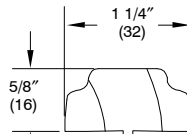

W7554 – Mull Casing Cover

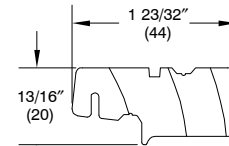

W1455 – Mulling Casing Base

TO ORDER REPLACEMENT WOOD PARTS

When ordering replacement wood parts specify:



1. profile number;
2. rough opening;
3. handing;
4. length;
5. finish.

REPLACEMENT PARTS

ORDERING REPLACEMENT VINYL, ALUMINUM OR FIBERGLASS PARTS FOR THE OUTSWING BI-FOLD DOOR TO ORDER REPLACEMENT PARTS

When ordering replacement parts specify:

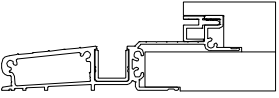
1. profile number;
2. rough opening;
3. length;
4. handing;
5. finish (where applicable).

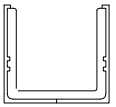
| ILLUSTRATION <i>NOT TO SCALE</i> | DESCRIPTION | LENGTH | OPER./COLOR | PART NUMBER |
|---|--|------------------------------|----------------|--|
|  | Bi-Fold Sill - 6 9/16" Extruded Aluminum, Douglas Fir Cap | 111" 147" 222" | BZ Anodized | 11195500 11195501 11195503 |
| | | 147" 222" | Clear Anodized | 11195502 11195504 |
|  | 6 9/16" Thermally Broken ADA Sill | 147" 183" 222" 294" | BZ | 11102444 11102447 11102446 11102445 |
| | | 147" 183" 222" 294" | Clear | 11195523 11195524 11195525 11195526 |
|  | Floor Channel <i>Includes: Bronze Anodized Channel PVC insert, black</i> | 222" | | 11195509 |

ORDERING REPLACEMENT PANELS FOR THE WOOD AND CLAD OUTSWING BI-FOLD DOOR

To order replacement panels specify:

1. OM of panel;
NOTE: OM of panel does not include astragal, or sweep.
2. active, or folding;
 - a. active – multi-point lock
 - b. panel style
3. handing per bi-fold configuration (from left exterior);
4. glazing;
5. finish;
6. glazing bead profile (should include all standard options).
 - a. ovolo
 - b. ogee
 - c. square

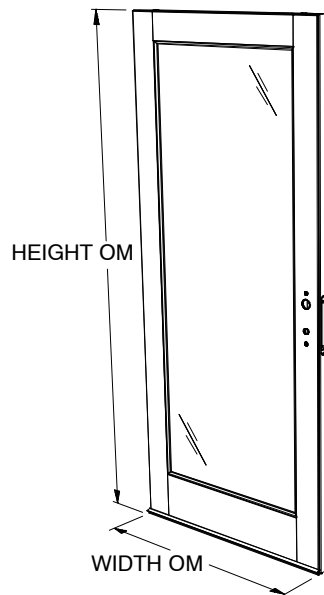

**Wood Active Panel
Exterior View**



**Clad Active Panel
Exterior View**

NOTE: Weather Strip is included with all panels (beige & bronze) and pile weather strip.

Active panels include multi-point lock system.

Folding panels include panel cover (beige, bronze) and dust block.

ORDERING ENERGY PANELS FOR SINGLE GLAZED WOOD OUTSWING BI-FOLD DOOR

If you are replacing an existing energy panel, determine the outside measurement of the existing energy panel. Find the sizes that correspond to the width and height indicated on the following chart. Energy panels are available for the single glazed Wood Outswing Bi-Fold Doors. Aluminum surrounds are available in bronze, or stone white.

When ordering energy panels specify:

1. size; If there is no existing EP from which to obtain the OM of the panel, determine the size of the EP by using the conversion chart below. The daylight opening is the measurement of the visible glass.
2. color of surround;
3. glass type.

| Single Glazed | | | | |
|--|-----------|-----------|--------|-----------|
| Wood Outswing Bi-Fold Doors manufactured 2006 – Present | | | | |
| Daylight Opening to OM of EP | | | | |
| Daylight Width + 1 3/8" = OM Width of EP | | | | |
| Daylight Height + 1 3/8" = OM Height of EP | | | | |
| WIDTH | | | HEIGHT | |
| SIZE | (65 ht.) | OM-WIDTH | SIZE | OM-HEIGHT |
| CN 26 | (65 ht.) | 19 15/32" | | |
| CN 30 | (65 ht.) | 25 15/32" | | |
| CN 16 | (66R ht.) | 12 7/8" | CN 66R | 65" |
| CN 26R | | 20 5/32" | | |
| CN 30R | | 26 5/32" | | |
| CN 20 | | 14 31/32" | CN 68 | 67 1/2" |
| CN 26 | | 20 31/32" | CN 70 | 71 1/2" |
| CN 28 | | 22 31/32" | CN 80 | 81" |
| CN 30 | | 26 31/32" | | |

ENERGY PANEL PARTS

Energy panels are attached with turn buttons. Turn button styles may vary depending on current stock. You will receive the most current style in the color of your choice. (Discontinued black turn buttons will be replaced by brown.)

When ordering energy panel parts specify:

1. quantity;
2. description;
3. color;
4. part number.

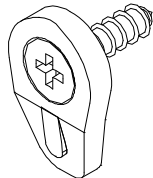
| ILLUSTRATION <i>NOT TO SCALE</i> | DESCRIPTION | COLOR | PART NUMBER | |
|---|---|-------|-------------|------------------|
|  | Turn Button All turn buttons include a #8x3/4" SS full thread screw | | <u>Each</u> | <u>Pkg of 50</u> |
| | | SW | 11869294 | 11869314 |
| | | CL | 11869309 | 11869315 |
| | | PB | 11869292 | 11869312 |
| | | BZ | 11869291 | 11869311 |
| | | BN | 11869293 | 11869313 |