

# Clad Ultimate Outswing Bi-Fold Door

Unit Features.....	1
Standard Divided Lite Option .....	5
Optional Interior Square Simulated Divided Lite .....	6
Minimum and Maximum Guidelines (Standard and Storm Plus IZ3) .....	9
Certified Sizes and Ratings.....	11
Standard Size Chart - Certified Units (Widths).....	12
Standard Size Chart - Non-Certified Units (Widths).....	13
Standard Size Chart (Heights) .....	14
Access Panel - Net Clear Opening.....	15
Sill Detail: Standard Sill .....	19
Sill Detail: Standard Sill - Storm Plus IZ3.....	20
Sill Detail: Low Profile Sill.....	21
Sill Detail: Floor Channel Sill.....	22
Section Details: Raised and Flat Panel Placement.....	23
Section Details: Horizontal .....	24
Section Details: Horizontal - Storm Plus IZ3 .....	25
\\Section Details: Horizontal with Screen .....	26
Section Details: Horizontal with Screen - Storm Plus IZ3 .....	27



# Clad Ultimate Outswing Bi-fold Door

## Unit Features

### Bi-fold Door:

CMOBFD - Clad Ultimate Outswing Bi-fold Door and Storm Plus IZ3

- Choose from 1 to 16 panels, 91 configurations. Configurations include left, right, or center operation. Some configurations include an access panel that opens like a traditional swinging door for easy access. Other configurations have folding panels that allow for an uninhibited opening.

### Frame:

- Frame components are 1 1/16" (27) thick with a jamb depth of 5 9/16" (142)
- Frame consists of jamb(s), head jamb, and sill
- Constructed of finger-jointed, edge-glued core with clear pine to the interior and extruded aluminum to the exterior. Finger-joint material may be used on header lengths over 12' (3658).
- Alternative wood species include Mahogany, Mixed Grain Douglas Fir, Cherry or White Oak
- Standard frame head and jambs are pine core with alternate species veneer

### Sill:

- Performance sill is designed to be installed into any floor foundation and is made as a sealed draining system with enhanced thermal properties
  - Material: Glass-filled polyurethane, beige or bronze
  - Extruded aluminum sill insert, beige or bronze
  - Frame weather strip, beige or black
  - Extruded aluminum sill liner, beige or bronze default (optional wood-wrapped oak, cherry, mahogany)
  - 6 21/32" (169) wide x 2 5/32" (55) tall
- Low Profile Sill
  - Material: Aluminum exterior and interior separated by a thermal break, clear or dark bronze anodized
  - 6 21/32" (169) wide x 1 7/64" (28) high
  - No performance warranty for air/water infiltration
- Floor Channel
  - Material: Extruded aluminum, beige or bronze
  - 1 49/64" (24) wide x 1 7/64" (28) high
  - No performance warranty for air/water infiltration

### Panel:

- Constructed of finger-jointed, edge-glued core with clear pine to the interior and extruded aluminum to the exterior.
- Panel thickness: 2 1/4" (57)
  - Top and bottom rail heights, and stile widths: 4 3/4" (121)
  - Top and bottom rail material
    - Finger-joint core is used for Pine, Vertical Grain Douglas Fir, Mahogany and Cherry
    - LVL is used for White Oak
- Stile material
  - LVL is used for all species.
- Astragal:
  - Astragals applied to one panel in configurations that are bi-parting.
  - Astragal profile: Ogee profile defaults to ogee sticking, square profile defaults to square sticking.
- Raised/Flat panel option: (not available with CE mark)
  - Available with traditional (8 1/8") bottom rail.
  - Standard stamped raised panel uses .080" (2) aluminum to the exterior with foam backing
  - Flat panel uses .125" (3) aluminum to the exterior
  - Core is medium density fiberboard (MDF) with non finger-jointed wood laminated to the interior

# Clad Ultimate Outswing Bi-fold Door

## Unit Features

### Hardware:

#### • Hinges

- Includes pivot, hinge, offset hinge, end carrier and intermediate sets
- Material: Aluminum hinge leaves with stainless steel carriers
- Available Colors: Painted: White, Satin Nickel, Bronze, or Anodized: Matte Black
- Optional mixed finishes available

#### • Multi-point lock:

- Applied to active panel
- 2 3/8" backset with latch engagement and three locking points: deadbolt, sill bolt, and head bolt
- All active panels have multi-point locks

#### • Contemporary handle set finish options (Default)

- Painted: Matte Black, Dark Bronze,
- Plated: Oil Rubbed Bronze PVD, Satin Nickel PVD
- Gallery Collection Hardware available in all finishes except Brass

#### • Traditional handle set finish options (Option)

- Painted: White, Dark Bronze, Matte Black
- Plated: Oil Rubbed Bronze, Oil Rubbed Bronze PVD, Satin Nickel PVD
- Gallery Collection Hardware available in all finishes except Brass

#### • Folding Panel Handle

- Material: Zinc
- Available Colors: Painted: White, Dark Bronze, Matte Black, or Plated: Satin Nickel

#### • Inactive Panel Lock

- Manual flush bolts are default. Optional inactive trim set with use of multi-point or dummy trim set with use of manual flush bolt

#### • Magnetic door catch assembly

- Color: housing matches cladding color, with a black magnet

### Lock Status Sensor (Optional):

- Refer to **Lock Status Sensor Installation Instructions** for requirements.
- To achieve a closed and locked status, the Lock Status Sensor requires that the door must be closed to depress the anti-slam mechanism so that the door can be manually locked. It allows easy integration with home automation systems using a wireless connection.
  - Requires purchase of secondary transmitter for operation. Marvin will prep for this option. Wired connection not available.
  - Wireless Lock Status Sensor is located within the operating panel.
- Sensor Location will always be integrated into the locking hardware system.

## Clad Ultimate Outswing Bi-fold Door

### Unit Features Continued

#### Glass and Glazing:

- Glazing method: Insulating - Dual Pane or Tri Pane
- Glazing seal: Silicone glazed
- Standard glass: Insulating Dual Pane Low E2 with Argon or Air
- Optional dual-pane glass make-ups:
  - Low E1 Argon or Air,
  - Low E3 Argon or Air,
  - Low E2/ERS Argon or air,
  - Low E3/ERS Argon or air, clear, tints, tempered, obscure, and decorative glass options
- Optional Tri Pane glass make-ups:
  - Low E2/E1 Argon, Krypton-Argon, or Air
  - Low E3/E1 Argon, Krypton-Argon, or Air
  - Low E1 Argon, Krypton-Argon, or Air
- Available glass types:
  - Laminated
  - Tempered
  - Obscure
- Tints:
  - Bronze
  - Gray
  - Green
  - Reflective Bronze
- Decorative glass options:
  - Frost
  - Reed
  - Narrow Reed
  - Rain
  - Sandblasted
  - Glue Chip
- All glass is of select quality complying with ASTM C 1036. Tempered or Laminated safety glazing per CPSC 16 CFR 1201. Insulating glass is manufactured and tested to pass level ASTM 2190 and is IGCC certified.
- StormPlus IZ3 has tempered exterior pane.
- For additional specialty glazing options, please contact your Marvin representative.

# Clad Ultimate Outswing Bi-fold Door

## Unit Features

### Weather Strip:

- All units are constructed with vinyl weather strip at all panel perimeter joints. Weather strip exposed to the exterior will be a UV (ultraviolet) resistant material.
- Sill weather strip
  - Foam-filled leaf
  - Colors: Beige for beige sill, Black for bronze sill
- Jamb and Head Jamb weather strip
  - Foam-filled leaf
  - Colors: Beige or Black
- Panel weather strip
  - Bottom rail cap weather strip
    - Foam filled leaf
    - Colors: Beige (for beige performance sills), Beige (for clear anodized low profile sill), Black (for bronze sills)
  - Top rail cap weather strip
    - Bulb
    - Colors: Beige or Black
  - Stile weather strip
    - Bulb (bi-parting swinging panel) - Beige or Black
    - Foam-filled bulb (exterior) - Beige or Black
    - Foam-filled leaf (exterior) - Beige or Black
    - Foam-filled leaf (interior) - Beige or Black
    - Rigid vinyl (bi-parting inactive panel) - Beige or Black
  - Astragal weather strip
    - Bulb
    - Colors: Beige or Black

### Interior Screen:

- Scenic Door Ultimate Sliding Screen
  - Screen Frame color:
    - Standard: White, Bronze, Black, and Clear Anodized.
    - Options: Screen sill will default to the screen color, but screen sills can be any of the three colors.
  - Handle Pull colors: Black and White
- Screen mesh: Vinyl-coated polyester
  - Color: Charcoal
- Uni-Directional Screen:
  - Open from left to right or right to left
  - Maximum Screen Frame OM Width is 152 17/64" (3868)
  - Not available on bi-parting door
- Bi-Parting Screen:
  - Two screens open from each side and meet together
  - Maximum Screen Frame OM Width is 296 17/64" (7525)
- Maximum Screen OM Height for all configurations is 125 5/32" (3179)

### Packaging:

- Knocked-Down (KD) only
  - Panels are packaged in cardboard and stretch wrapped up to CN3690 panel sizes. Panels over CN3690 are packaged and shipped on returnable racks where an 8,000 pound capable fork lift is required. Frames are packaged in skeleton wood crates.

# Clad Ultimate Outswing Bi-fold Door

## Standard Divided Lite Option



Insulating Glass

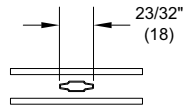

Aluminum 23/32"  
Contour GBG

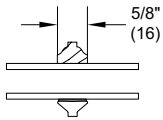

5/8" SDL

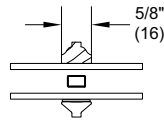

5/8" SDL  
W/Spacer

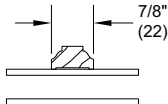

7/8" SDL

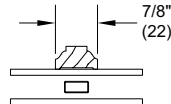

7/8" SDL  
W/Spacer Bar

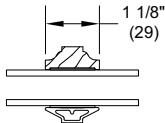

1 1/8" SDL

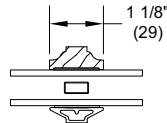

1 1/8" SDL  
W/Spacer Bar

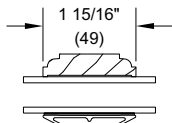

1 15/16" SDL

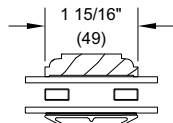

1 15/16" SDL  
W/Two Spacer Bars

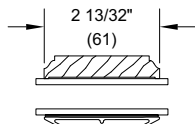

2 13/32" SDL

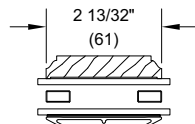

2 13/32" SDL  
W/Two Spacer Bars

# Clad Ultimate Outswing Bi-fold Door

## Optional Interior Square Simulated Divided Lite

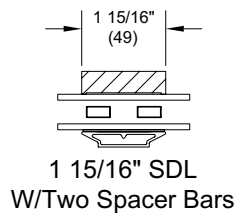
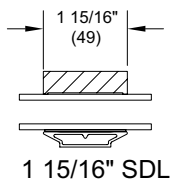
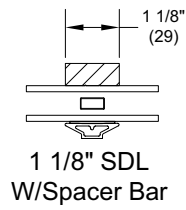
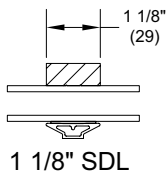
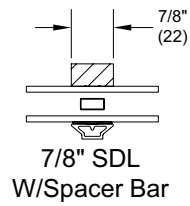
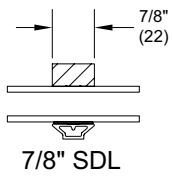
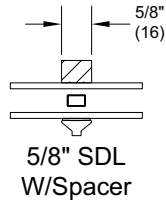
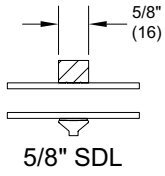



**Configurations**

**Bi-Parting (Unequal) Units**

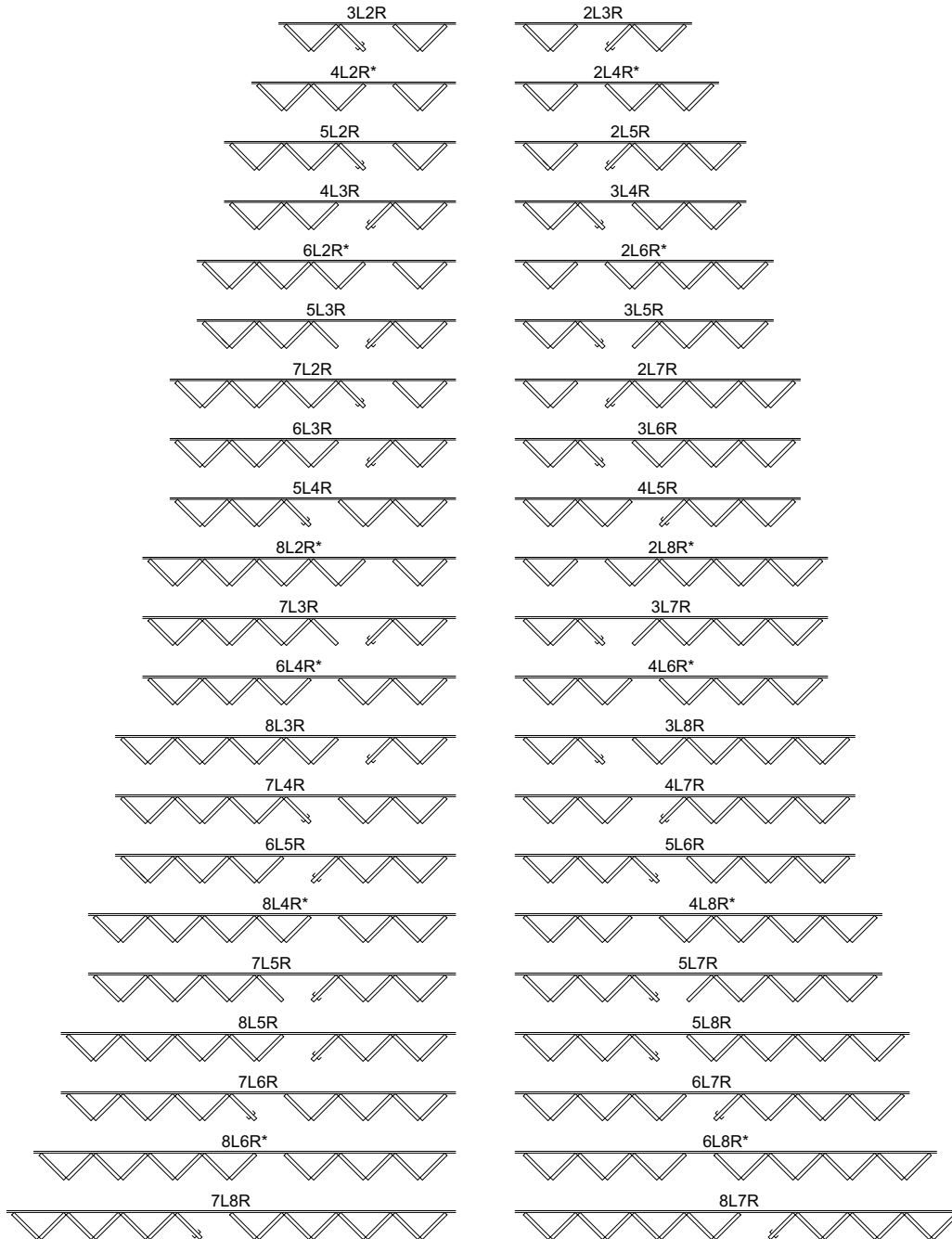

\* Not accessible from the exterior.

**Configurations**

Stationary Unit



Uni-directional Left  
or Right Units

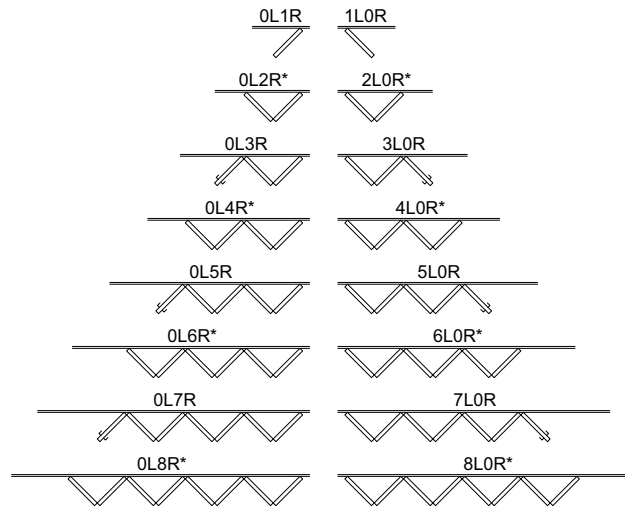

Uni-directional Left  
or Right Units with  
Operating Panel/s

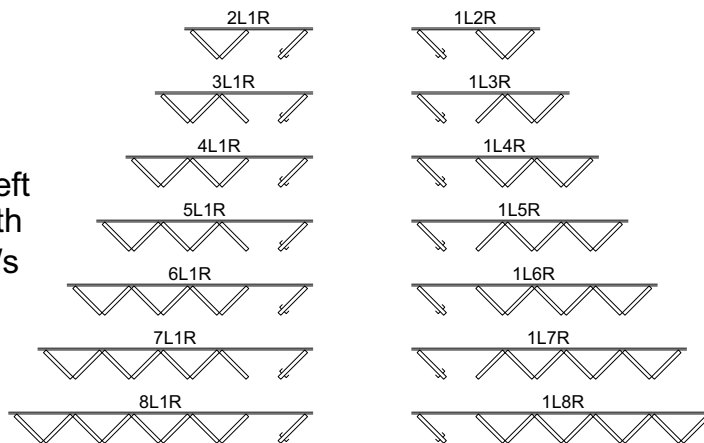

Bi-parting (equal)  
Units

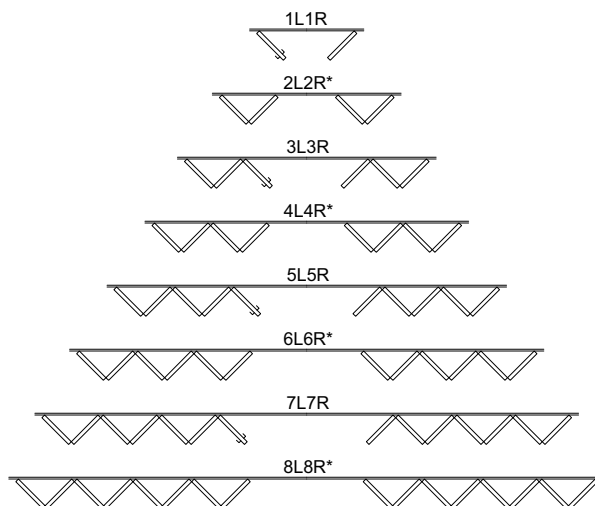

\* Not accessible from the exterior.

# Clad Ultimate Outswing Bi-fold Door

## Minimum and Maximum Guidelines (Standard and Storm Plus IZ3)

Minimum and Maximum Panel Size														
Panel Size	Min Panel Size								Max Panel Size					
	Min Width		Min Folding Panel Height		Min Active Swing Panel Height		Min Inactive Swing Panel w/flush bolts Height		Height		Width		Height	
	in	mm	in	mm	in	mm	in	mm	in	mm	in	mm	in	mm
Operator	29 1/16	(738)	51 17/32	(1309)	52 1/8	(1324)	59 15/32	(1511)	NA		41 1/16	(1043)	114 5/16	(2904)
Stationary	14 5/32	(360)	NA		NA		NA		22 1/8	(562)	150 5/32	(3814)	114 5/16	(2904)

NOTE: Minimum Width based on Manufacturer's minimum glass size limits of 6" x 16"  
 Minimum Stationary panel width of 20 5/32" if glass height is between 12" and 15.999"

Frame Size** Operator Units	Min Frame Size							
	Min Width		Min Frame w/folding panel Height		Min Frame w/active swing panel Height		Min Frame Height w/inactive swing panel w/flush bolts	
	in	mm	in	mm	in	mm	in	mm
Performance Sill	32 29/32	(836)	56 23/32	(1441)	57 5/16	(1456)	64 21/32	(1642)
Low Profile Sill	32 29/32	(836)	56 1/2	(1435)	57 3/32	(1450)	64 7/16	(1637)
Floor Channel***	32 29/32	(836)	55 25/64	(1407)	55 63/64	(1422)	63 21/64	(1609)

Frame Size** Operator Units	Max Frame Size									
	Uni-directional Width (8L or 8R)		Uni-directional w/1 swing panel Width (8L1R or 1L8R)		Bi-Parting w/unequal panels per side Width (8L7R or 7L8R)		Bi-Parting w/equal panels per side Width (8L8R)		Height	
	in	mm	in	mm	in	mm	in	mm	in	mm
Performance Sill	333 15/16	(8482)	375 1/8	(9528)	622 13/16	(15819)	664 13/64	(16871)	119 1/2	(3035)
Low Profile Sill	333 15/16	(8482)	375 1/8	(9528)	622 13/16	(15819)	664 13/64	(16871)	119 9/32	(3030)
Floor Channel***	333 15/16	(8482)	375 1/8	(9528)	622 13/16	(15819)	664 13/64	(16871)	118 11/64	(3002)

NOTE: Storm Plus IZ3 available with performance sill only.

\*\* Frame size widths in operator configurations are not available within these ranges:

*Unidirectional Configurations: > 44.902 (largest one panel) to < 62.239 (smallest two panel)*

*Unidirectional Configurations: > 86.239 (largest two panel) to < 91.467 (smallest three panel)*

*Biparting Configurations: > 86.144 (largest two panel) to < 91.422 (smallest three panel)*

\*\*\* Frame height measured to top of floor channel

## Clad Ultimate Outswing Bi-fold Door

### Minimum / Maximum Guidelines (Standard and Storm Plus IZ3)

Frame Size** Stationary Unit	Min Frame Size				Max Frame Size			
	Min Width		Min Frame Height		Max Width		Height	
	in	mm	in	mm	in	mm	in	mm
Performance Sill	18	(457)	27 5/16	(694)	154	(3912)	119 1/2	(3035)
Low Profile Sill	18	(457)	27 3/32	(688)	154	(3912)	119 9/32	(3030)
Floor Channel***	18	(457)	25 63/64	(660)	154	(3912)	118 11/64	(3002)

NOTE: Minimum Width based on Manufacturer's minimum glass size limits of 6" x 16"

Minimum Stationary panel width of 23.995" if glass height is between 12" and 15.999"

Minimum and Maximum Inputs for units with Screens							
Style	Sill Type	Minimum Frame Size			Maximum Frame Size		
		Width		Height	Width		Height
		in	mm		in	mm	
Uni-Directional	Performance Sill	32 29/32	(836)	Equals Min Frame Height	148 55/64	(3781)	Equals Max Frame Height
	Low Profile Sill	32 29/32	(836)	Equals Min Frame Height	148 55/64	(3781)	Equals Max Frame Height
	Floor Channel	32 29/32	(836)	Equals Min Frame Height	148 55/64	(3781)	Equals Max Frame Height
Bi-Parting	Performance Sill	62 9/64	(1578)	Equals Min Frame Height	292 55/64	(7439)	Equals Max Frame Height
	Low Profile Sill	62 9/64	(1578)	Equals Min Frame Height	292 55/64	(7439)	Equals Max Frame Height
	Floor Channel	62 9/64	(1578)	Equals Min Frame Height	292 55/64	(7439)	Equals Max Frame Height

NOTE: Storm Plus IZ3 available with performance sill only.

\*\* Frame size widths in operator configurations are not available within these ranges:

*Unidirectional Configurations: > 44.902 (largest one panel) to < 62.239 (smallest two panel)*

*Unidirectional Configurations: > 86.239 (largest two panel) to < 91.467 (smallest three panel)*

*Biparting Configurations: > 86.144 (largest two panel) to < 91.422 (smallest three panel)*

\*\*\* Frame height measured to top of floor channel

## Certified Sizes and Ratings

Certified Sizes and Ratings Tables (Performance Sill)										
Product	Air Tested to psf	Water Tested to psf	Structural Overload Tested to psf	Certification Rating	Design Pressure (DP)	Max Width mm		Max Height In		# of Panels
						in	mm	in	mm	
Clad Ultimate Outswing Bifold Door (21080)	1.57	7.5	75	SP-PG50	50	251 9/32	(6383)	95 1/2	(2426)	6
Clad Ultimate Outswing Bifold Door (210100)	1.57	7.5	60	SP-PG40	40	251 9/32	(6383)	119 1/2	(3035)	6
Clad Ultimate Outswing Bifold Door Stationary (36100)	1.57	8.25	+82.5/-97.5	SP-PG55	55	44 29/32	(1141)	119 1/2	(3035)	1

StormPlus IZ3 Certified Sizes and Ratings Tables (Performance Sill)										
Product	Air Tested to psf	Water Tested to psf	Structural Tested to psf	Certification Rating	Design Pressure (DP)	Max Width		Max Height		# of Panels
						in	mm	in	mm	
Clad Ultimate Outswing Bi-Fold Door	1.57	7.5	+/-75	SP-PG50	50	251 9/32	(6383)	95 1/2	(2426)	6
Clad Ultimate Outswing Bi-Fold Door	1.57	7.5	+/-75	SP-PG50	50	215 9/32	(5468)	119 1/2	(3035)	6
Clad Ultimate Outswing Bi-Fold Door - Stationary Unit	1.57	7.5	+/-75	SP-PG50	50	44 29/32	(1141)	119 1/2	(3035)	1

# Clad Ultimate Outswing Bi-fold Door

## Standard Size Chart - Certified Units (Widths)

Ultimate Outswing Bifold Door											
Width											
Unit Type	CN	Masonry Opening		Rough Opening		Frame Size		Panel OM		Daylight Opening	
		in	mm	in	mm	in	mm	in	mm	in	mm
O (Stationary)	2-6	33 13/32	(848)	33 29/32	(861)	32 29/32	(836)	29 1/16	(738)	19 19/32	(498)
	3-0	39 13/32	(1001)	39 29/32	(1014)	38 29/32	(988)	35 1/16	(891)	25 19/32	(650)
	3-6	45 13/32	(1153)	45 29/32	(1166)	44 29/32	(1141)	41 1/16	(1043)	31 19/32	(803)
1L or 1R	2-6	33 13/32	(848)	33 29/32	(861)	32 29/32	(836)	29 1/16	(738)	19 19/32	(498)
	3-0	39 13/32	(1001)	39 29/32	(1014)	38 29/32	(988)	35 1/16	(891)	25 19/32	(650)
	3-6	45 13/32	(1153)	45 29/32	(1166)	44 29/32	(1141)	41 1/16	(1043)	31 19/32	(803)
1L1R LH or 1L1R RH	5-0	62 41/64	(1591)	63 9/64	(1604)	62 9/64	(1578)	29 1/16	(738)	19 19/32	(498)
	6-0	74 41/64	(1896)	75 9/64	(1909)	74 9/64	(1883)	35 1/16	(891)	25 19/32	(650)
	7-0	86 41/64	(2201)	87 9/64	(2213)	86 9/64	(2188)	41 1/16	(1043)	31 19/32	(803)
2L or 2R	5-0	62 47/64	(1594)	63 15/64	(1606)	62 15/64	(1581)	29 1/16	(738)	19 19/32	(498)
	6-0	74 47/64	(1898)	75 15/64	(1911)	74 15/64	(1886)	35 1/16	(891)	25 19/32	(650)
	7-0	86 47/64	(2203)	87 15/64	(2216)	86 15/64	(2190)	41 1/16	(1043)	31 19/32	(803)
2L1R or 1L2R	7-6	91 59/64	(2335)	92 27/64	(2348)	91 27/64	(2322)	29 1/16	(738)	19 19/32	(498)
	9-0	109 59/64	(2792)	110 27/64	(2805)	109 27/64	(2779)	35 1/16	(891)	25 19/32	(650)
	10-6	127 59/64	(3249)	128 27/64	(3262)	127 27/64	(3237)	41 1/16	(1043)	31 19/32	(803)
3L or 3R	7-6	91 31/32	(2336)	92 15/32	(2349)	91 15/32	(2323)	29 1/16	(738)	19 19/32	(498)
	9-0	109 31/32	(2793)	110 15/32	(2806)	109 15/32	(2780)	35 1/16	(891)	25 19/32	(650)
	10-6	127 31/32	(3250)	128 15/32	(3263)	127 15/32	(3238)	41 1/16	(1043)	31 19/32	(803)
3L1R or 1L3R	10-0	121 13/64	(3079)	121 45/64	(3091)	120 45/64	(3066)	29 1/16	(738)	19 19/32	(498)
	12-0	145 13/64	(3688)	145 45/64	(3701)	144 45/64	(3676)	35 1/16	(891)	25 19/32	(650)
	14-0	169 13/64	(4298)	169 45/64	(4311)	168 45/64	(4285)	41 1/16	(1043)	31 19/32	(803)
4L or 4R	10-0	121 19/64	(3081)	121 51/64	(3094)	120 51/64	(3068)	29 1/16	(738)	19 19/32	(498)
	12-0	145 19/64	(3691)	145 51/64	(3703)	144 51/64	(3678)	35 1/16	(891)	25 19/32	(650)
	14-0	169 19/64	(4300)	169 51/64	(4313)	168 51/64	(4288)	41 1/16	(1043)	31 19/32	(803)
2L2R	10-0	121 5/16	(3082)	121 13/16	(3094)	120 13/16	(3069)	29 1/16	(738)	19 19/32	(498)
	12-0	145 5/16	(3691)	145 13/16	(3704)	144 13/16	(3678)	35 1/16	(891)	25 19/32	(650)
	14-0	169 5/16	(4301)	169 13/16	(4313)	168 13/16	(4288)	41 1/16	(1043)	31 19/32	(803)
4L1R or 1L4R	12-6	150 31/64	(3822)	150 63/64	(3835)	149 63/64	(3810)	29 1/16	(738)	19 19/32	(498)
	15-0	180 31/64	(4584)	180 63/64	(4597)	179 63/64	(4572)	35 1/16	(891)	25 19/32	(650)
	17-6	210 31/64	(5346)	210 63/64	(5359)	209 63/64	(5334)	41 1/16	(1043)	31 19/32	(803)
5L or 5R	12-6	150 17/32	(3824)	151 1/32	(3836)	150 1/32	(3811)	29 1/16	(738)	19 19/32	(498)
	15-0	180 17/32	(4586)	181 1/32	(4598)	180 1/32	(4573)	35 1/16	(891)	25 19/32	(650)
	17-6	210 17/32	(5348)	211 1/32	(5360)	210 1/32	(5335)	41 1/16	(1043)	31 19/32	(803)
5L1R or 1L5R	15-0	179 25/32	(4566)	180 9/32	(4579)	179 9/32	(4554)	29 1/16	(738)	19 19/32	(498)
	18-0	215 25/32	(5481)	216 9/32	(5493)	215 9/32	(5468)	35 1/16	(891)	25 19/32	(650)
	21-0	251 25/32	(6395)	252 9/32	(6408)	251 9/32	(6382)	41 1/16	(1043)	31 19/32	(803)
6L or 6R	15-0	179 7/8	(4569)	180 3/8	(4581)	179 3/8	(4556)	29 1/16	(738)	19 19/32	(498)
	18-0	215 7/8	(5483)	216 3/8	(5496)	215 3/8	(5470)	35 1/16	(891)	25 19/32	(650)
	21-0	251 7/8	(6397)	252 3/8	(6410)	251 3/8	(6385)	41 1/16	(1043)	31 19/32	(803)
4L2R or 2L4R	15-0	179 57/64	(4569)	180 25/64	(4582)	179 25/64	(4556)	29 1/16	(738)	19 19/32	(498)
	18-0	215 57/64	(5483)	216 25/64	(5496)	215 25/64	(5471)	35 1/16	(891)	25 19/32	(650)
	21-0	251 57/64	(6398)	252 25/64	(6411)	251 25/64	(6385)	41 1/16	(1043)	31 19/32	(803)

# Clad Ultimate Outswing Bi-fold Door

## Standard Size Chart - Non-Certified Units (Widths)

Unit Type	CN	Masonry Opening		Rough Opening		Frame Size		Panel OM		Daylight Opening	
		in	mm	in	mm	in	mm	in	mm	in	mm
6L1R or 1L6R	17-6	209 1/16	(5310)	209 9/16	(5323)	208 9/16	(5297)	29 1/16	(738)	19 19/32	(498)
	21-0	251 1/16	(6377)	251 9/16	(6390)	250 9/16	(6364)	35 1/16	(891)	25 19/32	(650)
	24-6	293 1/16	(7444)	293 9/16	(7456)	292 9/16	(7431)	41 1/16	(1043)	31 19/32	(803)
7L or 7R	17-6	209 3/32	(5311)	209 19/32	(5324)	208 19/32	(5298)	29 1/16	(738)	19 19/32	(498)
	21-0	251 3/32	(6378)	251 19/32	(6391)	250 19/32	(6365)	35 1/16	(891)	25 19/32	(650)
	24-6	293 3/32	(7445)	293 19/32	(7457)	292 19/32	(7432)	41 1/16	(1043)	31 19/32	(803)
7L1R or 1L7R	20-0	238 11/32	(6054)	238 27/32	(6067)	237 27/32	(6041)	29 1/16	(738)	19 19/32	(498)
	24-0	286 11/32	(7273)	286 27/32	(7286)	285 27/32	(7260)	35 1/16	(891)	25 19/32	(650)
	28-0	334 11/32	(8492)	334 27/32	(8505)	333 27/32	(8480)	41 1/16	(1043)	31 19/32	(803)
8L or 8R	20-0	238 7/16	(6056)	238 15/16	(6069)	237 15/16	(6044)	29 1/16	(738)	19 19/32	(498)
	24-0	286 7/16	(7275)	286 15/16	(7288)	285 15/16	(7263)	35 1/16	(891)	25 19/32	(650)
	28-0	334 7/16	(8495)	334 15/16	(8507)	333 15/16	(8482)	41 1/16	(1043)	31 19/32	(803)
6L2R or 2L6R 4L4R	20-0	238 29/64	(6057)	238 61/64	(6069)	237 61/64	(6044)	29 1/16	(738)	19 19/32	(498)
	24-0	286 29/64	(7276)	286 61/64	(7289)	285 61/64	(7263)	35 1/16	(891)	25 19/32	(650)
	28-0	334 29/64	(8495)	334 61/64	(8508)	333 61/64	(8482)	41 1/16	(1043)	31 19/32	(803)
8L1R or 1L8R	22-6	267 5/8	(6798)	268 1/8	(6810)	267 1/8	(6785)	29 1/16	(738)	19 19/32	(498)
	27-0	321 5/8	(8169)	322 1/8	(8182)	321 1/8	(8156)	35 1/16	(891)	25 19/32	(650)
	31-6	375 5/8	(9541)	376 1/8	(9553)	375 1/8	(9528)	41 1/16	(1043)	31 19/32	(803)
7L3R LH or 7L3R RH 3L7R LH or 3L7R RH 5L5R LH or	25-0	296 29/32	(7541)	297 13/32	(7554)	296 13/32	(7529)	29 1/16	(738)	19 19/32	(498)
	30-0	356 29/32	(9065)	357 13/32	(9078)	356 13/32	(9053)	35 1/16	(891)	25 19/32	(650)
	35-0	416 29/32	(10589)	417 13/32	(10602)	416 13/32	(10577)	41 1/16	(1043)	31 19/32	(803)
8L2R or 2L8R 6L4R or 4L6R	25-0	297 1/64	(7544)	297 33/64	(7557)	296 33/64	(7531)	29 1/16	(738)	19 19/32	(498)
	30-0	357 1/64	(9068)	357 33/64	(9081)	356 33/64	(9055)	35 1/16	(891)	25 19/32	(650)
	35-0	417 1/64	(10592)	417 33/64	(10605)	416 33/64	(10579)	41 1/16	(1043)	31 19/32	(803)
8L3R or 3L8R 7L4R or 4L7R 6L5R or 5L6R	27-6	326 3/16	(8285)	326 11/16	(8298)	325 11/16	(8272)	29 1/16	(738)	19 19/32	(498)
	33-0	392 3/16	(9962)	392 11/16	(9974)	391 11/16	(9949)	35 1/16	(891)	25 19/32	(650)
	38-6	458 3/16	(11638)	458 11/16	(11651)	457 11/16	(11625)	41 1/16	(1043)	31 19/32	(803)
7L5R LH or 7L5R RH 5L7R LH or 5L7R RH	30-0	355 15/32	(9029)	355 31/32	(9042)	354 31/32	(9016)	29 1/16	(738)	19 19/32	(498)
	36-0	427 15/32	(10858)	427 31/32	(10870)	426 31/32	(10845)	35 1/16	(891)	25 19/32	(650)
	42-0	499 15/32	(12687)	499 31/32	(12699)	498 31/32	(12674)	41 1/16	(1043)	31 19/32	(803)
8L4R or 4L8R 6L6R	30-0	355 37/64	(9032)	356 5/64	(9044)	355 5/64	(9019)	29 1/16	(738)	19 19/32	(498)
	36-0	427 37/64	(10861)	428 5/64	(10873)	427 5/64	(10848)	35 1/16	(891)	25 19/32	(650)
	42-0	499 37/64	(12689)	500 5/64	(12702)	499 5/64	(12677)	41 1/16	(1043)	31 19/32	(803)
8L5R or 5L8R 7L6R or 6L7R	32-6	384 3/4	(9773)	385 1/4	(9785)	384 1/4	(9760)	29 1/16	(738)	19 19/32	(498)
	39-0	462 3/4	(11754)	463 1/4	(11767)	462 1/4	(11741)	35 1/16	(891)	25 19/32	(650)
	45-6	540 3/4	(13735)	541 1/4	(13748)	540 1/4	(13722)	41 1/16	(1043)	31 19/32	(803)
7L7R LH or 7L7R RH	35-0	414 1/32	(10516)	414 17/32	(10529)	413 17/32	(10504)	29 1/16	(738)	19 19/32	(498)
	42-0	498 1/32	(12650)	498 17/32	(12663)	497 17/32	(12637)	35 1/16	(891)	25 19/32	(650)
	49-0	582 1/32	(14784)	582 17/32	(14796)	581 17/32	(14771)	41 1/16	(1043)	31 19/32	(803)
8L6R or 6L8R	35-0	414 9/64	(10519)	414 41/64	(10532)	413 41/64	(10507)	29 1/16	(738)	19 19/32	(498)
	42-0	498 9/64	(12653)	498 41/64	(12666)	497 41/64	(12640)	35 1/16	(891)	25 19/32	(650)
	49-0	582 9/64	(14786)	582 41/64	(14799)	581 41/64	(14774)	41 1/16	(1043)	31 19/32	(803)
8L7R or 7L8R	37-6	443 5/16	(11260)	443 13/16	(11273)	442 13/16	(11248)	29 1/16	(738)	19 19/32	(498)
	45-0	533 5/16	(13546)	533 13/16	(13559)	532 13/16	(13534)	35 1/16	(891)	25 19/32	(650)
	52-6	623 5/16	(15832)	623 13/16	(15845)	622 13/16	(15820)	41 1/16	(1043)	31 19/32	(803)
8L8R	40-0	472 45/64	(12007)	473 13/64	(12020)	472 13/64	(11994)	29 1/16	(738)	19 19/32	(498)
	48-0	568 45/64	(14445)	569 13/64	(14458)	568 13/64	(14433)	35 1/16	(891)	25 19/32	(650)
	56-0	664 45/64	(16884)	665 13/64	(16896)	664 13/64	(16871)	41 1/16	(1043)	31 19/32	(803)

## Standard Size Chart (Heights)

Ultimate Outswing Bi-Fold Door - Unit Measurements															
Performance Sill (Height)															
Unit Type	CN	Masonry Opening		Rough Opening		Frame Size		Panel OM		Daylight Opening		Glass Size		Screen OM	
		in	mm	in	mm	in	mm	in	mm	in	mm	in	mm		
All Configurations	6-8	82 1/4	(2089)	82 1/2	(2096)	82	(2083)	76 13/16	(1951)	67 5/16	(1710)	68 5/8	(1743)	81 5/32	(2061)
	7-0	86 1/4	(2191)	86 1/2	(2197)	86	(2184)	80 13/16	(2053)	71 5/16	(1811)	72 5/8	(1845)	85 5/32	(2163)
	8-0	95 3/4	(2432)	96	(2438)	95 1/2	(2426)	90 5/16	(2294)	80 13/16	(2053)	82 1/8	(2086)	94 21/32	(2404)
	9-0	107 3/4	(2737)	108	(2743)	107 1/2	(2731)	102 5/16	(2599)	92 13/16	(2357)	94 1/8	(2391)	106 21/32	(2709)
	10-0	119 3/4	(3042)	120	(3048)	119 1/2	(3035)	114 5/16	(2904)	104 13/16	(2662)	106 1/8	(2696)	118 21/32	(3014)

Low Profile Sill (Height)															
Unit Type	CN	Masonry Opening		Rough Opening		Frame Size		Panel OM		Daylight Opening		Glass Size		Screen OM	
		in	mm	in	mm	in	mm	in	mm	in	mm	in	mm		
All Configurations	6-8	82 1/32	(2084)	82 9/32	(2090)	81 25/32	(2077)	76 13/16	(1951)	67 5/16	(1710)	68 5/8	(1743)	81 31/32	(2082)
	7-0	86 1/32	(2185)	86 9/32	(2192)	85 25/32	(2179)	80 13/16	(2053)	71 5/16	(1811)	72 5/8	(1845)	85 31/32	(2184)
	8-0	95 17/32	(2427)	95 25/32	(2433)	95 9/32	(2420)	90 5/16	(2294)	80 13/16	(2053)	82 1/8	(2086)	95 15/32	(2425)
	9-0	107 17/32	(2731)	107 25/32	(2738)	107 9/32	(2725)	102 5/16	(2599)	92 13/16	(2357)	94 1/8	(2391)	107 15/32	(2730)
	10-0	119 17/32	(3036)	119 25/32	(3043)	119 9/32	(3030)	114 5/16	(2904)	104 13/16	(2662)	106 1/8	(2696)	119 15/32	(3035)

Floor Channel (Height)															
Unit Type	CN	Masonry Opening		Rough Opening		Frame Size		Panel OM		Daylight Opening		Glass Size		Screen OM	
		in	mm	in	mm	in	mm	in	mm	in	mm	in	mm		
All Configurations	6-8	82 1/4	(2089)	81 11/64	(2062)	80 43/64	(2049)	76 13/16	(1951)	67 5/16	(1710)	68 5/8	(1743)	81 31/32	(2082)
	7-0	86 1/4	(2191)	85 11/64	(2163)	84 43/64	(2151)	80 13/16	(2053)	71 5/16	(1811)	72 5/8	(1845)	85 31/32	(2184)
	8-0	95 3/4	(2432)	94 43/64	(2405)	94 11/64	(2392)	90 5/16	(2294)	80 13/16	(2053)	82 1/8	(2086)	95 15/32	(2425)
	9-0	107 3/4	(2737)	106 43/64	(2710)	106 11/64	(2697)	102 5/16	(2599)	92 13/16	(2357)	94 1/8	(2391)	107 15/32	(2730)
	10-0	119 3/4	(3042)	118 43/64	(3014)	118 11/64	(3002)	114 5/16	(2904)	104 13/16	(2662)	106 1/8	(2696)	119 15/32	(3035)

NOTE: Storm Plus IZ3 available with performance sill only.



# Clad Ultimate Outswing Bi-fold Door

## Access Panel - Net Clear Opening

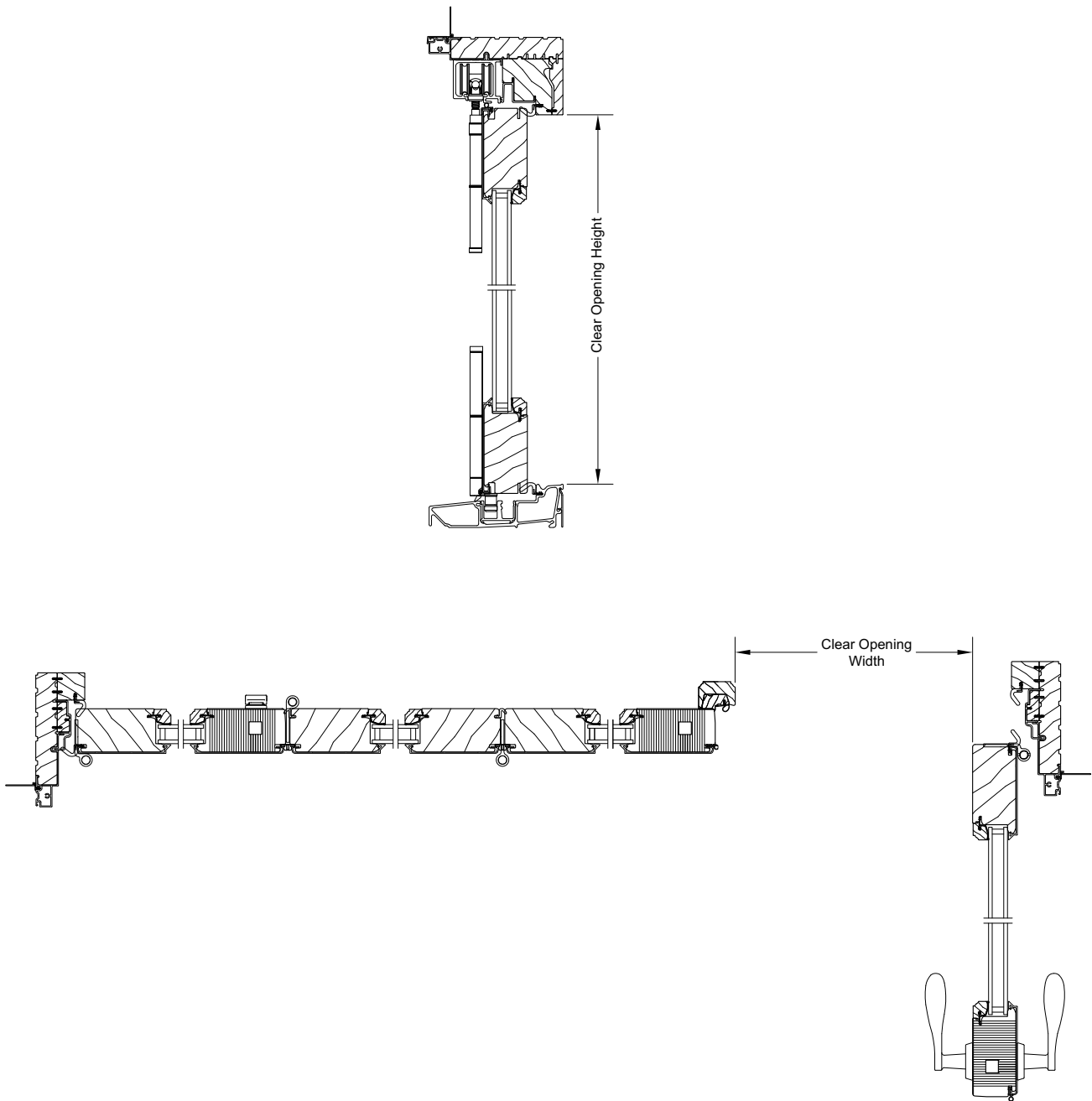

Access Panel - Net Clear Opening

Net Clear Opening Width							
Unit Configuration	Call Number	Net Clear Openings		Net Clear Opening Unidirectional Screen		Net Clear Opening Biparting Screen	
		ft-in	mm	ft-in	mm	ft-in	mm
O (Stationary)	2-6	NA	NA	NA	NA	NA	NA
	3-0	NA	NA	NA	NA	NA	NA
	3-6	NA	NA	NA	NA	NA	NA
1L or 1R	2-6	2-1 31/64	(647)	2-1 1/2	(647)	NA	NA
	3-0	2-7 31/64	(800)	2-7 1/2	(800)	NA	NA
	3-6	3-1 31/64	(952)	3-1 1/2	(952)	NA	NA
1L1R LH or 1L1R RH	5-0	2-1 3/16	(640)	2-1 3/16	(640)	2-1 3/16	(640)
	6-0	2-7 3/16	(792)	2-7 3/16	(792)	2-7 3/16	(792)
	7-0	3-1 3/16	(944)	3-1 3/16	(944)	3-1 3/16	(944)
2L or 2R	5-0	NA	NA	NA	NA	NA	NA
	6-0	NA	NA	NA	NA	NA	NA
	7-0	NA	NA	NA	NA	NA	NA
2L1R or 1L2R	7-6	2-1 3/16	(640)	2-1 3/16	(640)	2-1 3/16	(640)
	9-0	2-7 3/16	(792)	2-7 3/16	(792)	2-7 3/16	(792)
	10-6	3-1 3/16	(944)	3-1 3/16	(944)	3-1 3/16	(944)
3L or 3R	7-6	2-2 7/64	(663)	2-2 1/8	(663)	2-2 1/8	(663)
	9-0	2-8 7/64	(816)	2-8 1/8	(816)	2-8 1/8	(816)
	10-6	3-2 7/64	(968)	3-2 1/8	(968)	3-2 1/8	(968)
3L1R or 1L3R	10-0	2-1 3/16	(640)	2-1 3/16	(640)	2-1 3/16	(640)
	12-0	2-7 3/16	(792)	2-7 3/16	(792)	2-7 3/16	(792)
	14-0	3-1 3/16	(944)	3-1 3/16	(944)	3-1 3/16	(944)
4L or 4R	10-0	NA	NA	NA	NA	NA	NA
	12-0	NA	NA	NA	NA	NA	NA
	14-0	NA	NA	NA	NA	NA	NA
2L2R	10-0	NA	NA	NA	NA	NA	NA
	12-0	NA	NA	NA	NA	NA	NA
	14-0	NA	NA	NA	NA	NA	NA
4L1R or 1L4R 3L2R or 2L3R	12-6	2-1 3/16	(640)	2-1 3/16	(640)	2-1 3/16	(640)
	15-0	2-7 3/16	(792)	2-7 3/16	(792)	2-7 3/16	(792)
	17-6	3-1 3/16	(944)	3-1 3/16	(944)	3-1 3/16	(944)
5L or 5R	12-6	2-2 7/64	(663)	2-2 1/8	(663)	2-2 1/8	(663)
	15-0	2-8 7/64	(816)	2-8 1/8	(816)	2-8 1/8	(816)
	21-0	3-2 7/64	(968)	3-2 1/8	(968)	3-2 1/8	(968)

# Clad Ultimate Outswing Bi-fold Door

## Access Panel - Net Clear Opening

Net Clear Opening Width							
Unit Configuration	Call Number	Net Clear Openings		Net Clear Opening Unidirectional Screen		Net Clear Opening Biparting Screen	
		ft-in	mm	ft-in	mm	ft-in	mm
5L1R or 1L5R 3L3R LH or 3L3R RH	15-0	2-1 3/16	(640)	2-1 3/16	(640)	2-1 3/16	(640)
	18-0	2-7 3/16	(792)	2-7 3/16	(792)	2-7 3/16	(792)
	21-0	3-1 3/16	(944)	3-1 3/16	(944)	3-1 3/16	(944)
6L or 6R	15-0	NA	NA	NA	NA	NA	NA
	18-0	NA	NA	NA	NA	NA	NA
	21-0	NA	NA	NA	NA	NA	NA
4L2R or 2L4R	15-0	NA	NA	NA	NA	NA	NA
	18-0	NA	NA	NA	NA	NA	NA
	21-0	NA	NA	NA	NA	NA	NA
6L1R or 1L6R 5L2R or 2L5R 4L3R or 3L4R	17-6	2-1 3/16	(640)	NA	NA	2-1 3/16	(640)
	21-0	2-7 3/16	(792)	NA	NA	2-7 3/16	(792)
	24-6	3-1 3/16	(944)	NA	NA	3-1 3/16	(944)
7L or 7R	17-6	2-2 7/64	(663)	NA	NA	NA	NA
	21-0	2-8 7/64	(816)	NA	NA	NA	NA
	24-6	3-2 7/64	(968)	NA	NA	NA	NA
7L1R or 1L7R 5L3R LH or 5L3R RH 3L5R LH or 3L5R RH	20-0	2-1 3/16	(640)	NA	NA	2-1 3/16	(640)
	24-0	2-7 3/16	(792)	NA	NA	2-7 3/16	(792)
	28-0	3-1 3/16	(944)	NA	NA	3-1 3/16	(944)
8L or 8R	20-0	NA	NA	NA	NA	NA	NA
	24-0	NA	NA	NA	NA	NA	NA
	28-0	NA	NA	NA	NA	NA	NA
6L2R or 2L6R 4L4R	20-0	NA	NA	NA	NA	NA	NA
	24-0	NA	NA	NA	NA	NA	NA
	28-0	NA	NA	NA	NA	NA	NA
8L1R or 1L8R 7L2R or 2L7R 6L3R or 3L6R	22-6	2-1 3/16	(640)	NA	NA	NA	NA
	27-0	2-7 3/16	(792)	NA	NA	NA	NA
	31-6	3-1 3/16	(944)	NA	NA	NA	NA
7L3R LH or 7L3R RH 3L7R LH or 3L7R RH 5L5R LH or 5L5R RH	25-0	2-1 3/16	(640)	NA	NA	NA	NA
	30-0	2-7 3/16	(792)	NA	NA	NA	NA
	35-0	3-1 3/16	(944)	NA	NA	NA	NA
8L2R or 2L8R 6L4R or 4L6R	25-0	NA	NA	NA	NA	NA	NA
	30-0	NA	NA	NA	NA	NA	NA
	35-0	NA	NA	NA	NA	NA	NA
8L3R or 3L8R 7L4R or 4L7R 6L5R or 5L6R	27-6	2-1 3/16	(640)	NA	NA	NA	NA
	33-0	2-7 3/16	(792)	NA	NA	NA	NA
	38-6	3-1 3/16	(944)	NA	NA	NA	NA
7L5R LH or 7L5R RH 5L7R LH or 5L7R RH	30-0	2-1 3/16	(640)	NA	NA	NA	NA
	36-0	2-7 3/16	(792)	NA	NA	NA	NA
	42-0	3-1 3/16	(944)	NA	NA	NA	NA
8L4R or 4L8R 6L6R	30-0	NA	NA	NA	NA	NA	NA
	36-0	NA	NA	NA	NA	NA	NA
	42-0	NA	NA	NA	NA	NA	NA
8L5R or 5L8R 7L6R or 6L7R	32-6	2-1 3/16	(640)	NA	NA	NA	NA
	39-0	2-7 3/16	(792)	NA	NA	NA	NA
	45.6	3-1 3/16	(944)	NA	NA	NA	NA
7L7R LH or 7L7R RH	35-0	2-1 3/16	(640)	NA	NA	NA	NA
	42-0	2-7 3/16	(792)	NA	NA	NA	NA
	49-0	3-1 3/16	(944)	NA	NA	NA	NA
8L6R or 6L8R	35-0	NA	NA	NA	NA	NA	NA
	42-0	NA	NA	NA	NA	NA	NA
	49-0	NA	NA	NA	NA	NA	NA
8L7R or 7L8R	37-6	2-1 3/16	(640)	NA	NA	NA	NA
	45-0	2-7 3/16	(792)	NA	NA	NA	NA
	52-6	3-1 3/16	(944)	NA	NA	NA	NA
8L8R	40-0	NA	NA	NA	NA	NA	NA
	48-0	NA	NA	NA	NA	NA	NA
	56-0	NA	NA	NA	NA	NA	NA

NOTE: Dimension given as net clear opening for pull bar side

**Access Panel - Net Clear Opening**

Net Clear Opening Height					
All Configuration	Call Number	Performance Sill		Low Profile Sill and Floor Channel	
		ft - in	mm	ft - in	mm
	6-8	6-4	(1930)	6-4 53/64	(1951)
7-0	6-8	(2032)	6-8 53/64	(2053)	
8-0	7-6	(2286)	7-6 21/64	(2294)	
9-0	8-5 1/2	(2578)	8-6 21/64	(2599)	
10-0	9-5 1/2	(2883)	9-6 21/64	(2904)	

NOTE: Storm Plus IZ3 available with performance sill only.

# Clad Ultimate Outswing Bi-fold Door

## Sill Detail: Standard Sill

Scale: Not to Scale

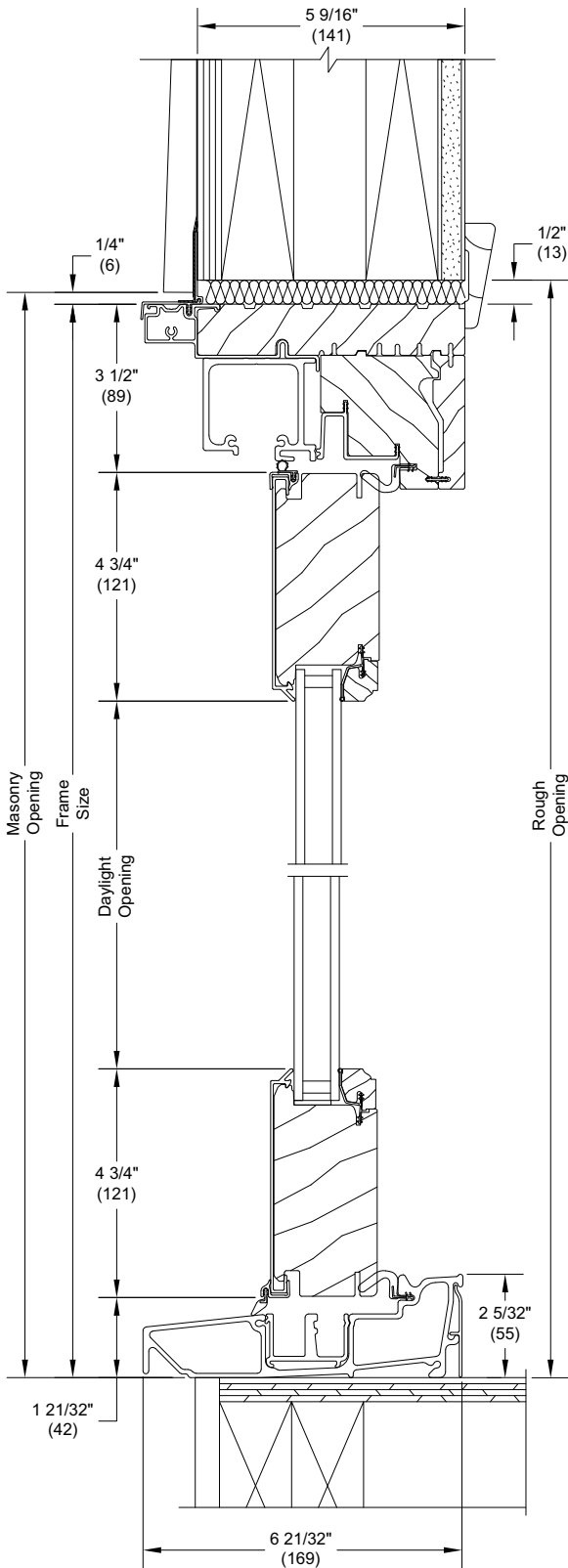

Head Jamb and Sill

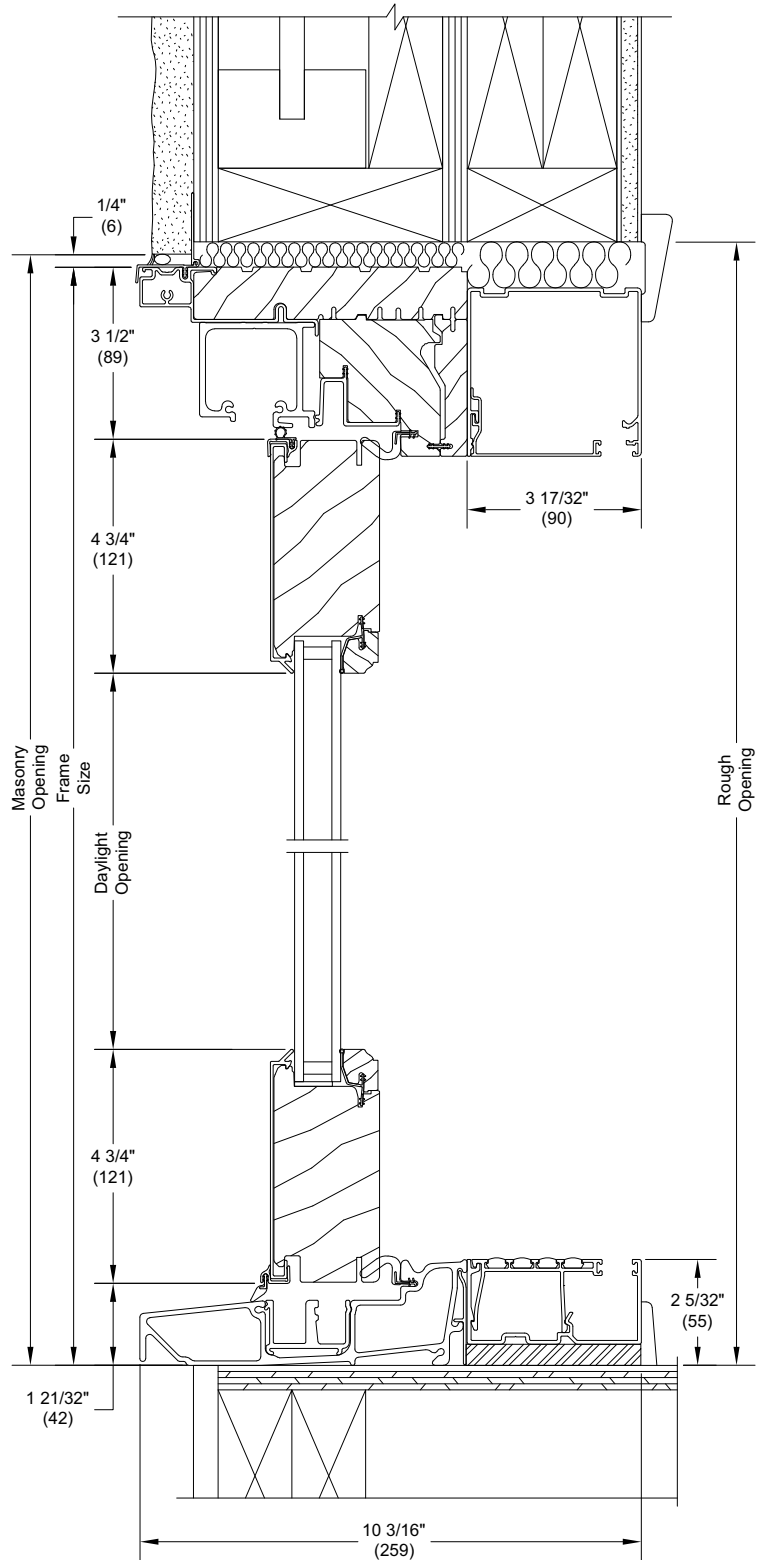

Head Jamb and Sill  
With Screen

# Clad Ultimate Outswing Bi-fold Door

## Sill Detail: Standard Sill - Storm Plus IZ3

Scale: Not to Scale

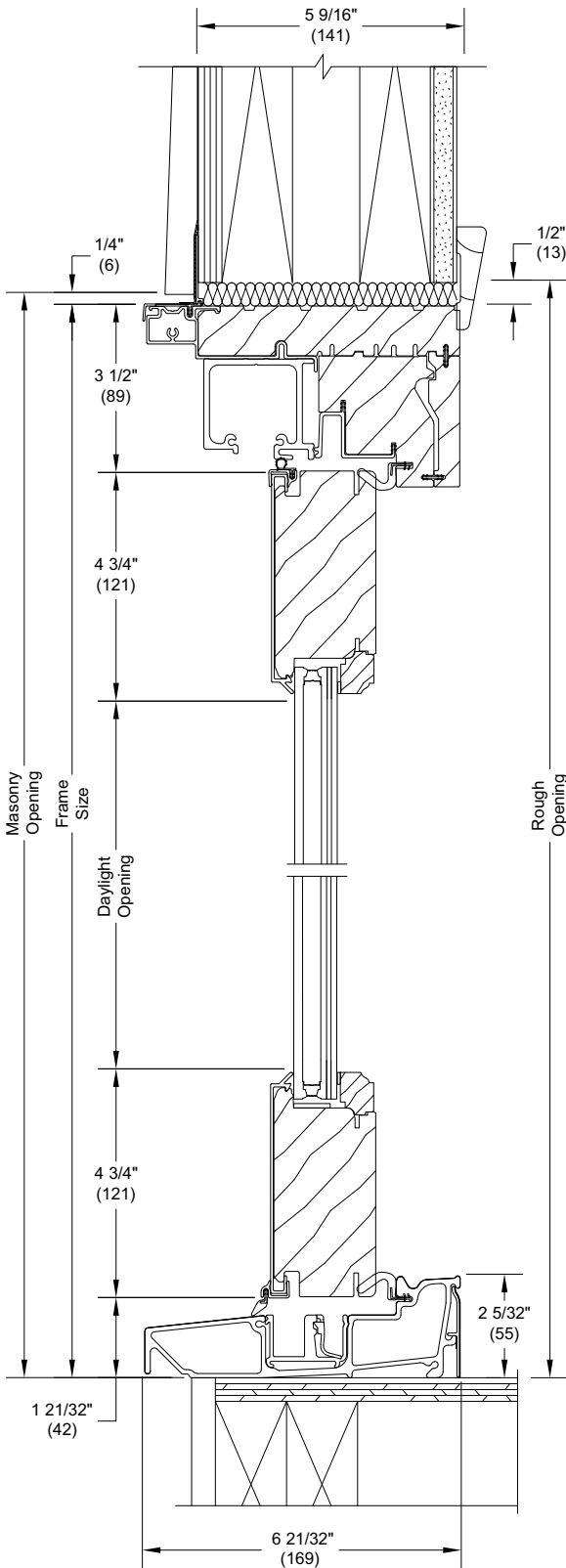

Head Jamb and Sill

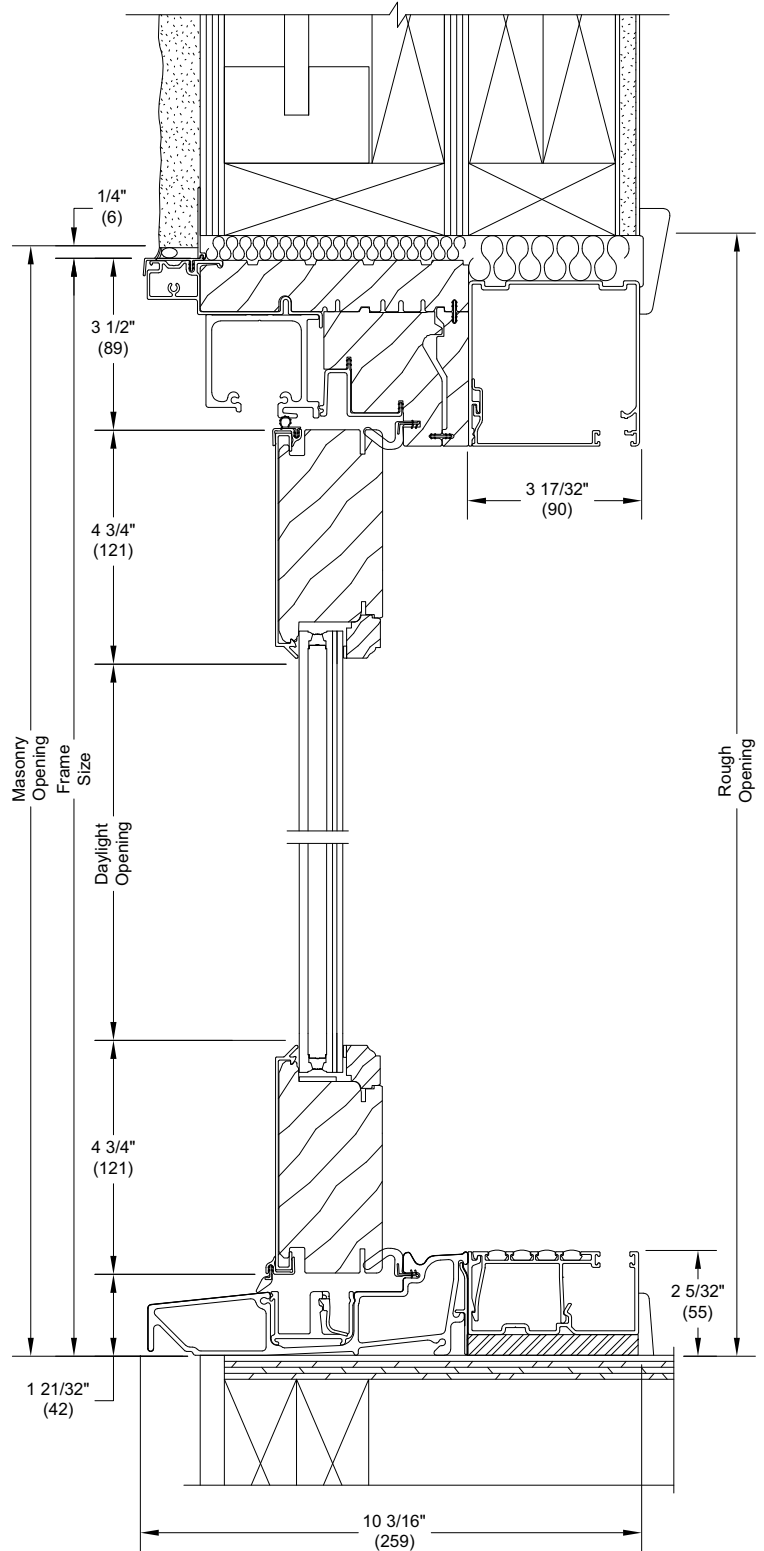

Head Jamb and Sill  
With Screen

# Clad Ultimate Outswing Bi-fold Door

## Sill Detail: Low Profile Sill

Scale: Not to Scale

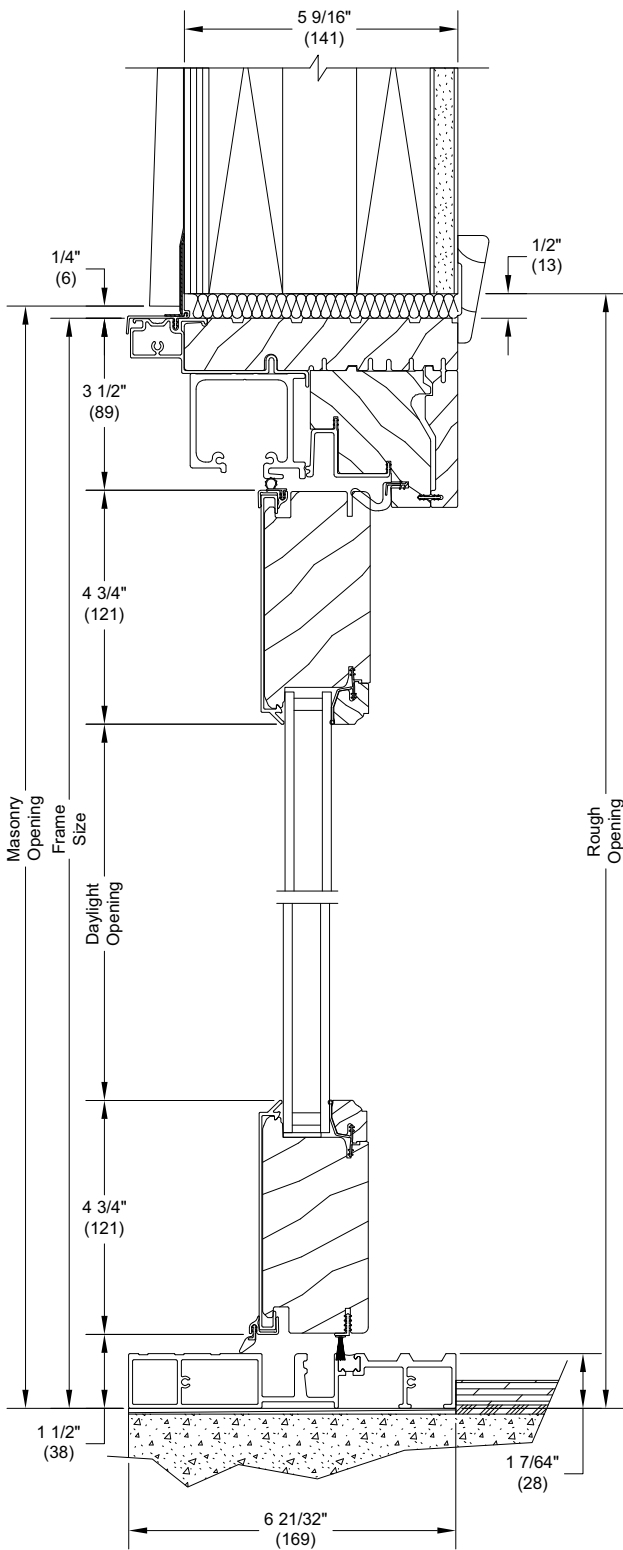

Head Jamb and Sill

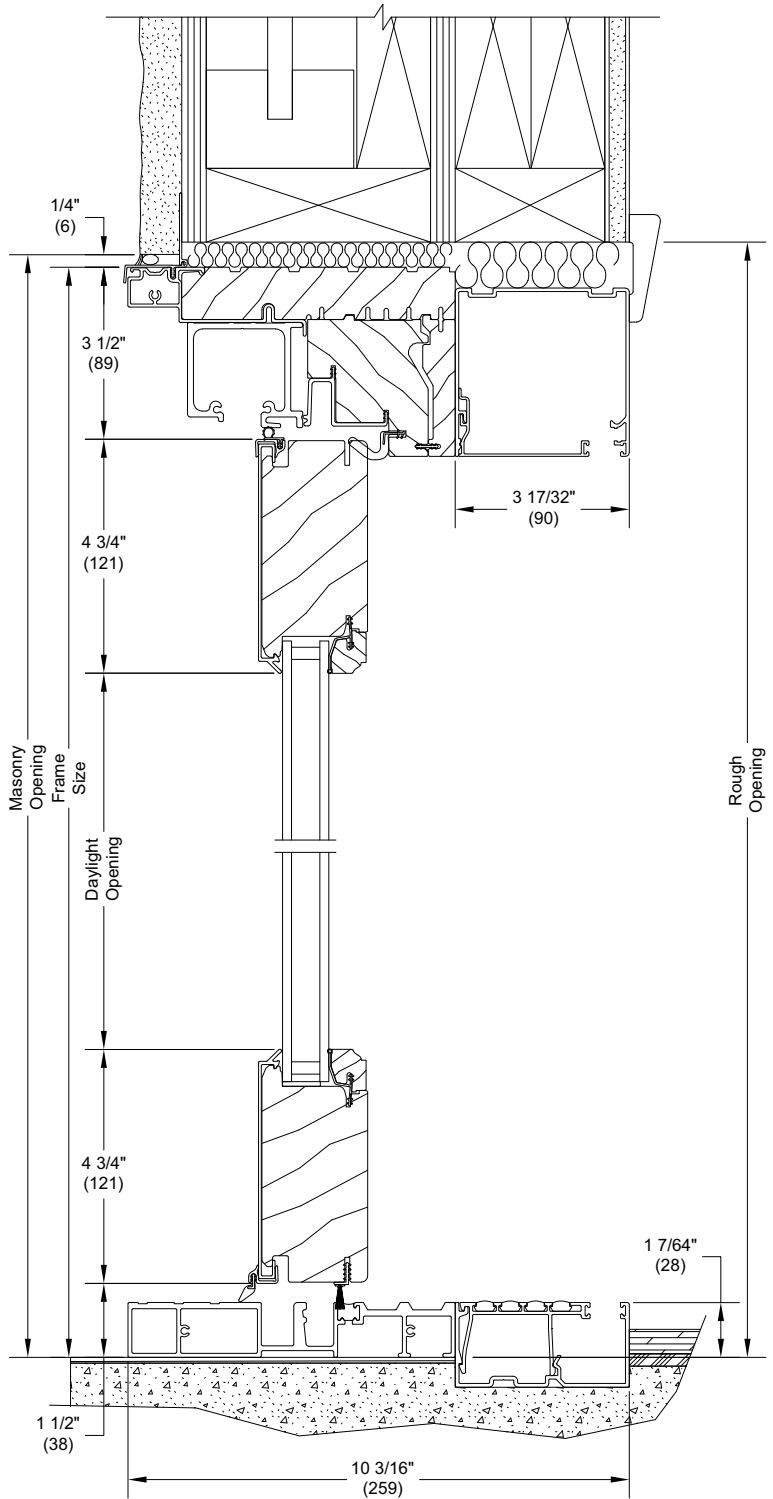

Head Jamb and Sill  
With Screen

*NOTE: Low profile sill is not available in Storm Plus IZ3.*

# Clad Ultimate Outswing Bi-fold Door

## Sill Detail: Floor Channel Sill

Scale: Not to Scale

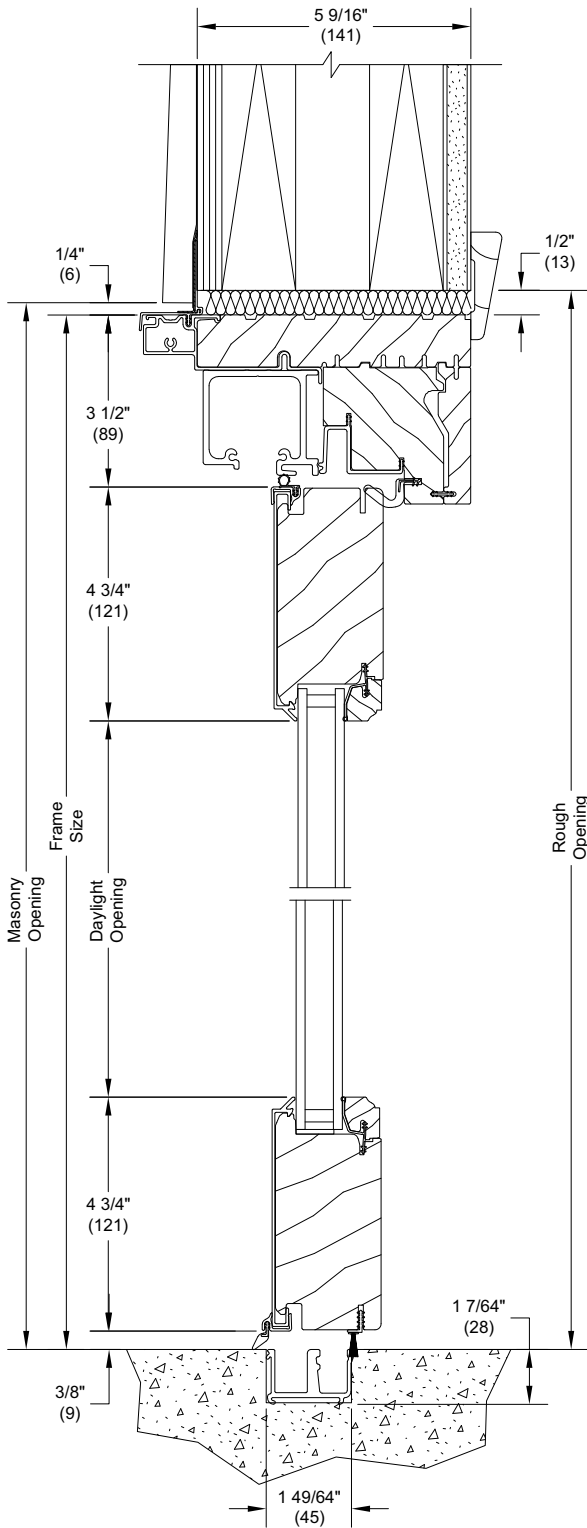

Head Jamb and Sill

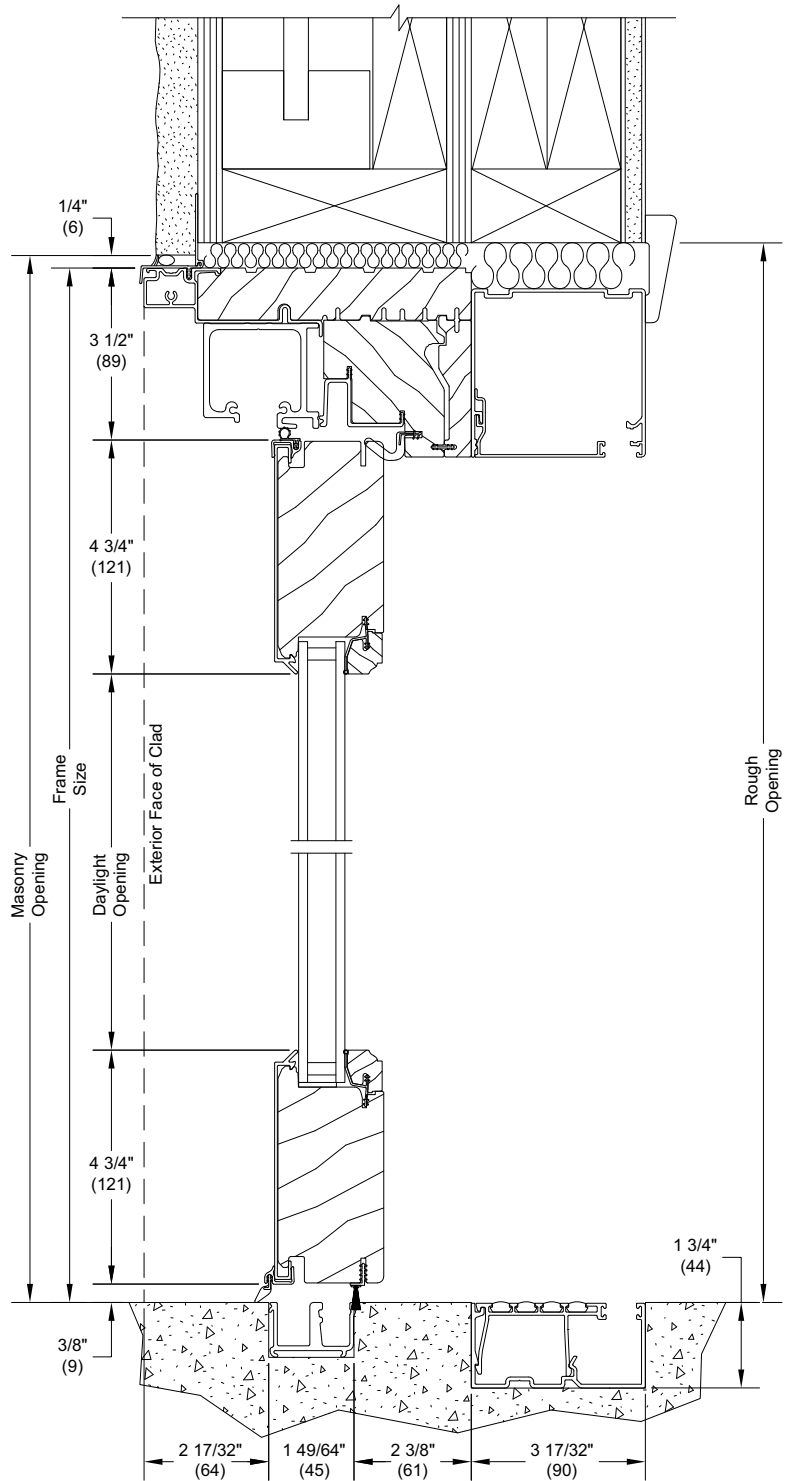

Head Jamb and Sill  
With Screen

*NOTE: Floor channel sill is not available in Storm Plus IZ3.*



# Clad Ultimate Outswing Bi-fold Door

## Section Details: Raised and Flat Panel Placement

Scale: Not to Scale

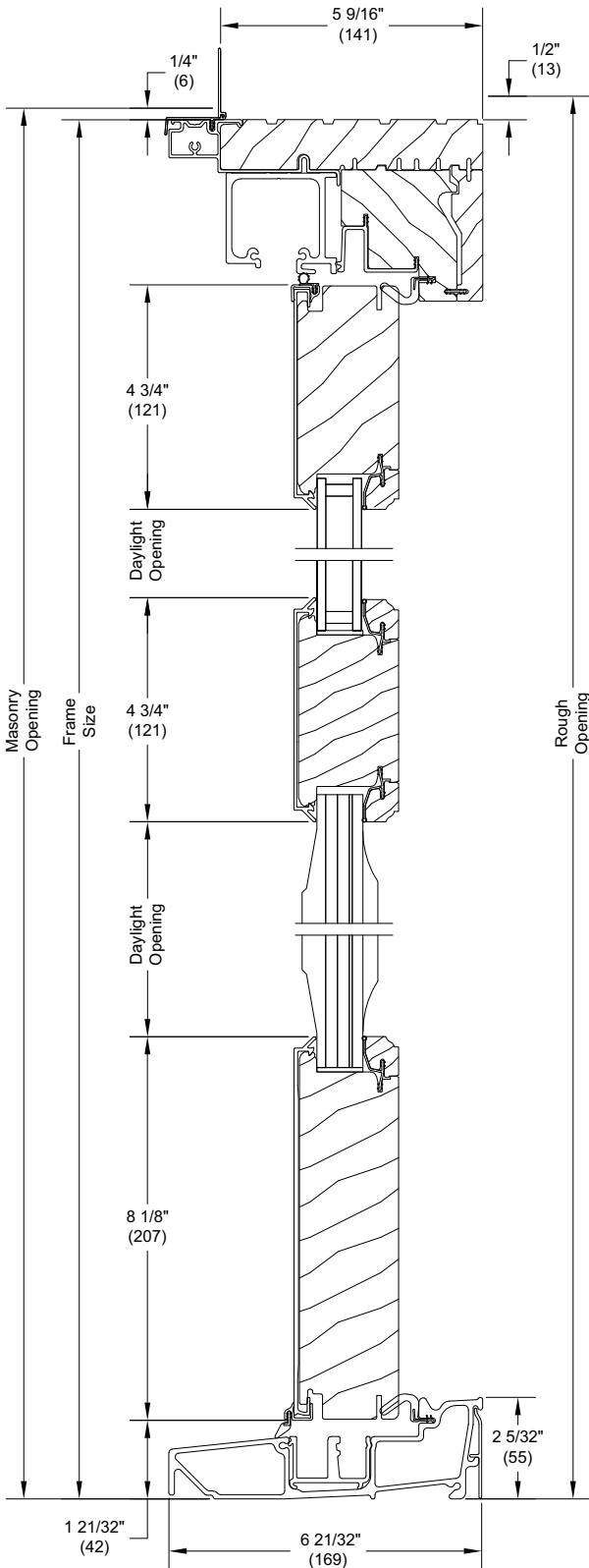

Head Jamb and Sill  
With Raised Panel

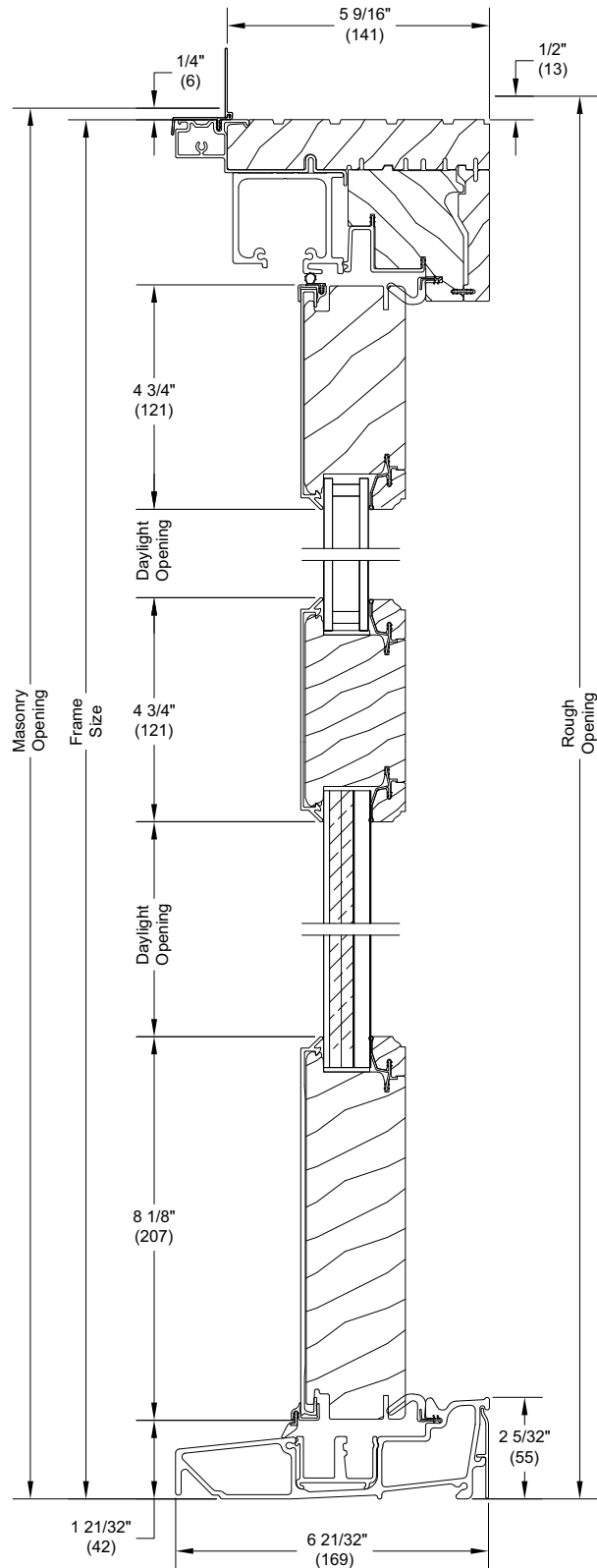

Head Jamb and Sill  
With Flat Panel

# Clad Ultimate Outswing Bi-fold Door

## Section Details: Horizontal

Scale: Note to Scale

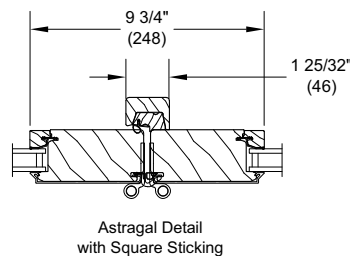
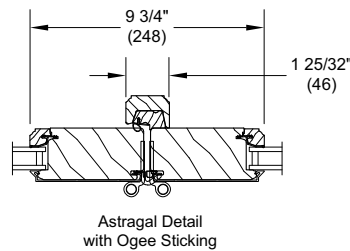
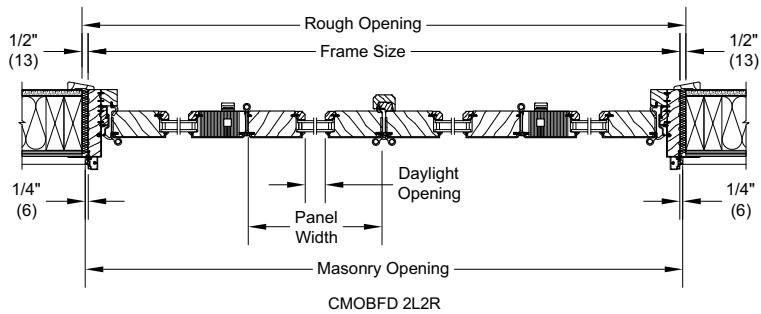
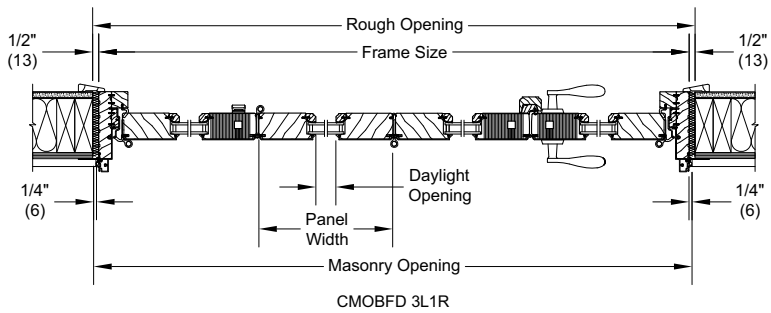
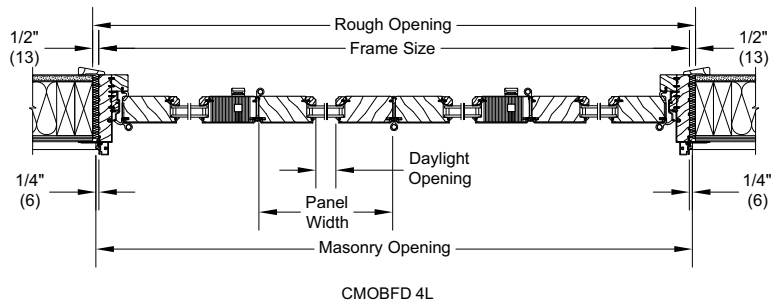

# Clad Ultimate Outswing Bi-fold Door

## Section Details: Horizontal - Storm Plus IZ3

Scale: Note to Scale

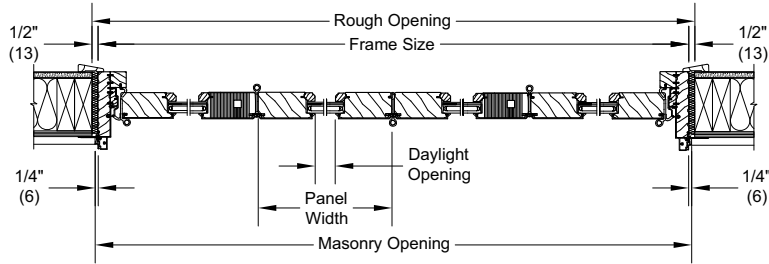

CMOBFD 4L

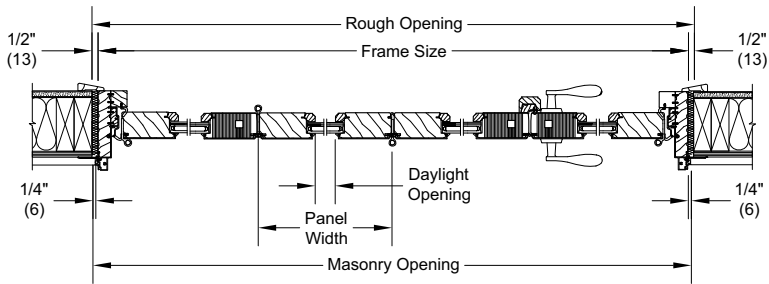

CMOBFD 3L1R

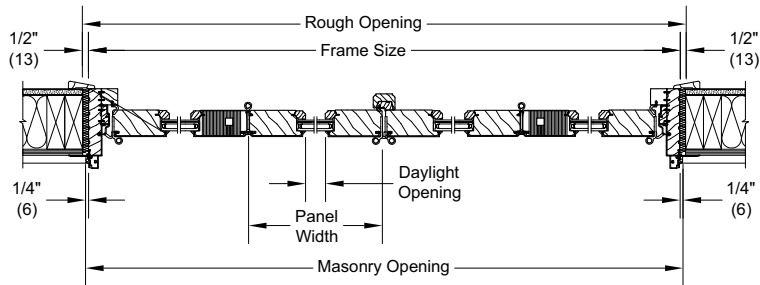

CMOBFD 2L2R

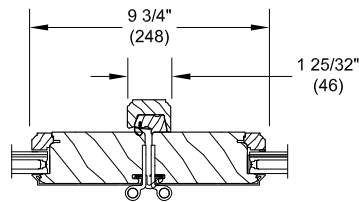

Astragal Detail  
with Ogee Sticking

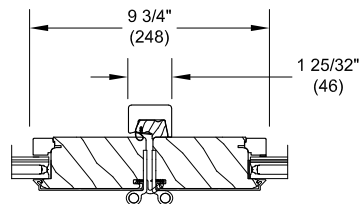

Astragal Detail  
with Square Sticking

# Clad Ultimate Outswing Bi-fold Door

## Section Details: Horizontal with Screen

Scale: Note to Scale

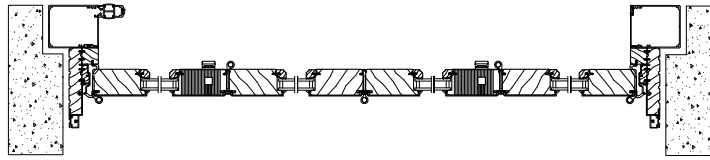

CMOBFD 4L

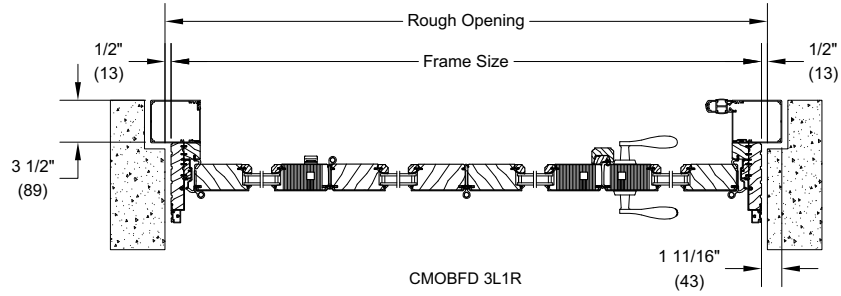

CMOBFD 3L1R

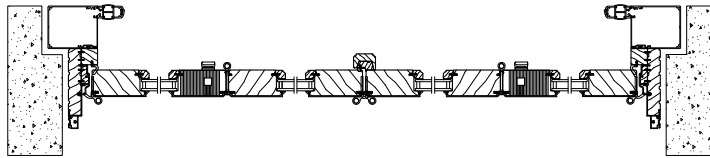

CMOBFD 2L2R

**Section Details: Horizontal with Screen - Storm Plus IZ3**

Scale: Note to Scale

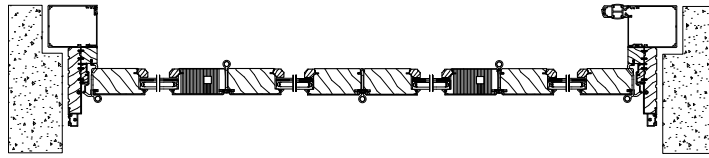

CMOBFD 4L

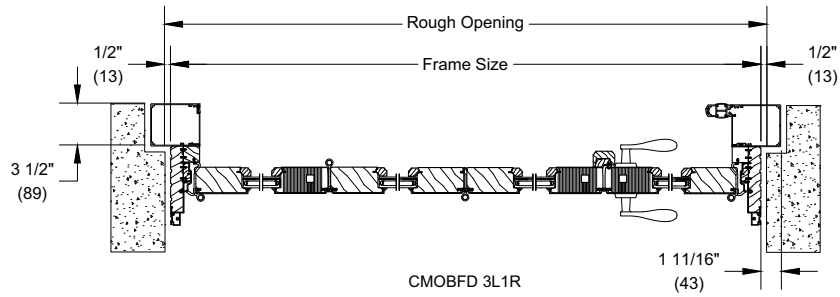

CMOBFD 3L1R

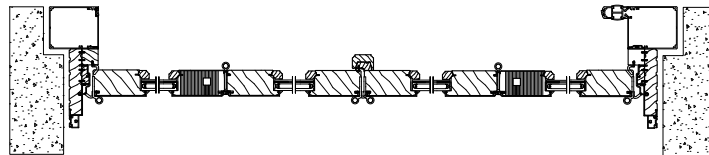

CMOBFD 2L2R