

# ESSENTIAL SLIDING PATIO DOOR

## Table of Contents

	<b>PAGE</b>
History .....	2
Part Identification – Two Panel Operator .....	4
Part Identification – Three Panel Operator .....	5
<b>Parts</b>	
Hardware .....	6
Aluminum .....	12
Miscellaneous .....	13
Weather Strip and Vinyl .....	15
Installation Kits .....	18
Wood Parts .....	19
Panel, Frame and DLO Charts .....	20
Panel, Screen and Grille Replacement .....	21
Screen Parts .....	22
Discontinued Hardware – Limited Availability (LA) .....	24
Discontinued Screen Parts – Limited Availability (LA) .....	25
Discontinued Screen Parts – No Availability (NA) .....	27

### **ATTENTION:**

- Specification and technical data are subject to change without notice.
- Numbers listed in parentheses ( ) are metric equivalents in millimeters rounded to the nearest whole number.

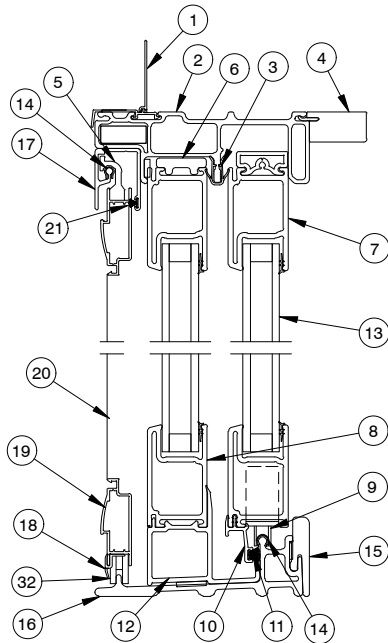
PRODUCED	UNIT TYPE	FEATURES OR CHANGES	DISCONTINUED
March 2008	Sliding Patio Door	Unit features 3/4" insulating Low E II tempered glass with Argon, single point mortise style locking system, stainless steel ball bearing twin roller operating system, 3 3/8" jamb with 4 9/16" or 6 9/16" extensions available, optional factory applied sheet rock return and field applied j-channel, and exterior non-keyed handle.  Pultruded fiberglass interior and exterior. White interior only with white hardware. Stone White, Pebble Gray, Bronze, Evergreen or Cashmere exteriors with hardware finish to match finish option selection. GBGs are white to the interior, exterior GBGs match exterior finish option selection.  PVC sill liner and color matched top hung screen.  Available in 2-panel (5068, 50610, 5080, 6068, 60610, 6080) and 3-panel (90610, 9080) configuration	Present
March 2009	Sliding Patio Door	Ebony exteriors introduced.	Present
May 2009	Sliding Patio Door	LoE <sup>3</sup> 366™ glass option introduced.	Present
February 2010	Sliding Patio Door	Introduced new handle design for the PVD Brass, Satin Nickel and Oil Rubbed bronze finish.	Present
2011	Sliding Patio Door	February 28, 2011 Introduced keyed option for complete handle sets. April 25, 2011 Introduced LoE-180™ glass option.	Present
January 2012	Sliding Patio Door	January 30, 2012 Introduced the 5' 10" CN.	Present
April 2012	Sliding Patio Door	April 30, 2012 Added the 32" NCO Handle Option.	Present
July 2012	Sliding Patio Door	Improved 9080 structural stability with product enhancements at the Leveling Block End Cap and top of Operator Panel.	Present
April 2013	Sliding Patio Door	Introduced special sizes 2-panel in 1/64" increments from the smallest size to the largest size within the current matrix.	Present
April 2014	Sliding Patio Door	April 28, 2014: Interior and Exterior Split Finish option became available so customers could choose different colors between exterior and interior handles. All current handle styles were given the name Cambridge. Handles are no longer available in sets.	Present
October 2014	Sliding Patio Door	October 24, 2014: Added Northfield hardware handle sets.	Present
February 2015	Sliding Patio Door	February 23, 2015 Introduced new nailing fin with drip.	Present
December 2016	Sliding Patio Door	December 19, 2016 Introduced new Jamb block	Present
December 2017	Sliding Patio Door	December 18, 2017 Added availability of customer specified lite cut configurations for GBG and to allow any color GBG on the exterior for standard or special sized units.	Present
February 2018	Sliding Patio Door	February 26, 2018: Standardized Ebony exterior from Essential Ebony to Marvin Ebony. Reduction of 2 jamb blocks per installation kit. Jamb bumper added, stationary interlock part numbers changed.	Present
June 2018	Sliding Patio Door	June 25, 2018: Introduced Matte Black Hardware and Black perimeter spacer color option.	Present
September 2018	Sliding Patio Door	September 24, 2018: Introduced Bronze and Ebony interior option. Stone White Jamb extension, Sheetrock return and Receiver are selectable for dark interior options.	Present

---

---

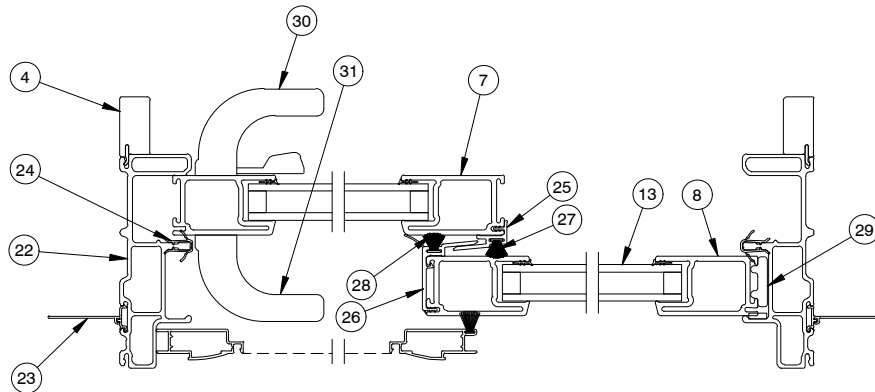
PRODUCED	UNIT TYPE	FEATURES OR CHANGES	DISCONTINUED
October 2018	Sliding Patio Door	October 29, 2018: Low E3 ERS glass type was added.	Present
December 2018	Sliding Patio Door	December 17, 2018: Introduced textured glass types: Obscure, Reed, Narrow Reed, Rain, Glue Chip and Frost and also colored glass types: Clear, Bronze, Gray and Green.	Present
January 2019	Sliding Patio Door	January 28, 2019: New screen design was implemented.	Present

**2 PANEL OPERATOR**



1. Head Jamb Nailing Fin
2. Head Jamb
3. Head Jamb Weather Strip, V1636/V2912
4. Jamb Extension
5. Screen Hanger, Guide
6. Stat. Panel Head Jamb Spacer
7. Operator Panel
8. Stationary Panel
9. Adjustable Roller
10. Operator Panel Drip Seal, V1637/V2903
11. Panel Seal Weather Strip
12. Stationary Panel Leveling Block, V1639/V2904
13. Insulating Glass
14. Stainless Steel Cap
15. Sill Liner, V1634
16. Sill
17. Head Jamb Screen Track, A3456
18. Screen Panel, Bottom Rail Expander, V3023
19. Screen Frame
20. Screen Mesh
21. Screen Frame Weather Strip
22. Jamb
23. Jamb Nailing Fin
24. Jamb Weather Strip, V1636/V2912
25. Operator Panel Interlock, V1646/V2908
26. Stationary Panel Interlock, V2827
27. Operator Interlock Pile Weather Strip
28. Stationary Interlock Pile Weather Strip
29. Panel Spacer
30. Interior Handle
31. Exterior Handle
32. Screen Guide

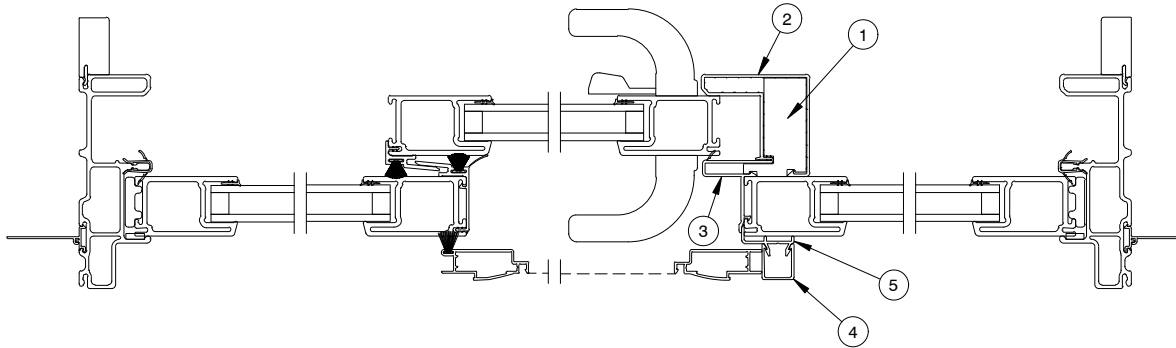
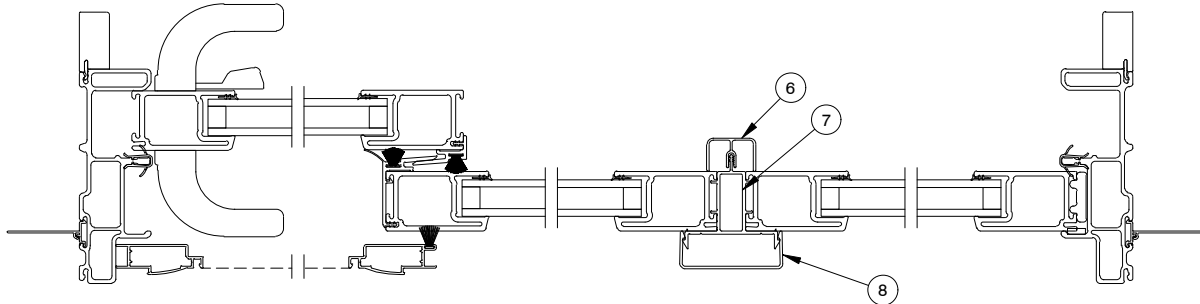
**HEAD JAMB AND SILL DETAIL OPERATOR**



**JAMB DETAIL**

**NOTE: XO CONFIGURATION SHOWN**

NOTE: Not to scale; specifications subject to change without notice.

**3 PANEL OPERATORS – JAMB DETAIL****3 PANEL JAMB DETAIL – OXO****3 PANEL JAMB DETAIL – XOO**

NOTE: Not to scale; specifications subject to change without notice.

- |   |                                       |
|---|---------------------------------------|
| 1. Astragal Core OXO, W9782               | 5. Screen Stop Astragal Base, A362    |
| 2. Astragal Cap Interior OXO, V1667/V2910 | 6. Mull Trim, Interior OOX/XOO, V1633 |
| 3. Astragal Cap Exterior OXO, V1663/V2909 | 7. Stationary Panel Spline, V1649     |
| 4. Screen Stop Astragal Cap, A361         | 8. Spline Cap Exterior, A1508         |

When ordering replacement Sliding Patio Door parts specify, part number, description, color (if applicable), and handing (if applicable).

*NOTE: All handles for post February 22, 2010 are interchangeable regardless of style or finish.*

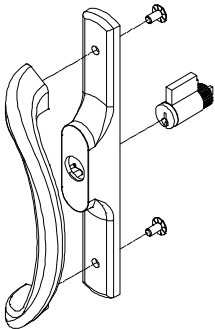
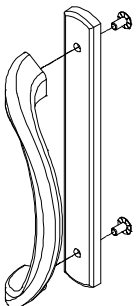
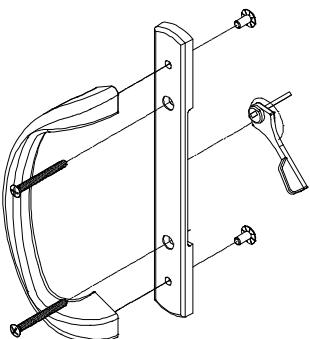
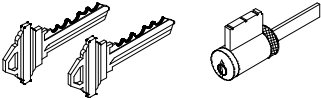
ILLUSTRATION <i>NOT TO SCALE</i>	DESCRIPTION	COLOR	PART NO.
	<p><b>Cambridge Handle Set, Exterior Keyed</b></p> <p><i>Includes:</i></p> <ul style="list-style-type: none"> <li>1 - Exterior Handle</li> <li>1 - Keyed Cylinder</li> <li>2 - Handle Screws</li> <li>1 - Exterior Escutcheon</li> </ul>	<ul style="list-style-type: none"> <li>Almond Frost</li> <li>White</li> <li>Brass PVD</li> <li>Satin Nickel PVD</li> <li>Oil Rubbed Bronze PVD</li> <li>Matte Black</li> </ul>	<ul style="list-style-type: none"> <li>10147195</li> <li>10147196</li> <li>10147197</li> <li>10147198</li> <li>10147199</li> <li>10147200</li> </ul>
	<p><b>Cambridge Handle Set, Exterior Non-Keyed</b></p> <p><i>Includes:</i></p> <ul style="list-style-type: none"> <li>1 - Exterior Handle</li> <li>2 - Handle Screws</li> <li>1 - Exterior Escutcheon - Non-keyed</li> </ul>	<ul style="list-style-type: none"> <li>Almond Frost</li> <li>White</li> <li>Brass PVD</li> <li>Satin Nickel PVD</li> <li>Oil Rubbed Bronze PVD</li> <li>Matte Black</li> </ul>	<ul style="list-style-type: none"> <li>11869072</li> <li>11869071</li> <li>11869073</li> <li>11869074</li> <li>11869075</li> <li>11869076</li> </ul>
	<p><b>Cambridge Handle Set, Interior</b></p> <p><i>Includes:</i></p> <ul style="list-style-type: none"> <li>1 - Interior Handle</li> <li>1 - Interior Escutcheon</li> <li>1 - Thumb Turn</li> <li>2 - #8 x 1 1/2" Machine screws</li> <li>2 - Handle Screws</li> <li>1 - Instruction</li> </ul>	<ul style="list-style-type: none"> <li>Almond Frost</li> <li>White</li> <li>Brass PVD</li> <li>Satin Nickel PVD</li> <li>Oil Rubbed Bronze PVD</li> <li>Matte Black</li> </ul>	<ul style="list-style-type: none"> <li>10147190</li> <li>10147191</li> <li>10147192</li> <li>10147193</li> <li>10147194</li> <li>10149195</li> </ul>
	<p><b>Cambridge Keyed Cylinder</b></p> <p><i>Includes:</i></p> <ul style="list-style-type: none"> <li>1 - Lock cylinder</li> <li>2 - Keys</li> </ul> <p><i>NOTE: For keyed alike cylinders, please contact your Marvin representative. Please supply the original order number, if available..</i></p>		<p>11860976</p>

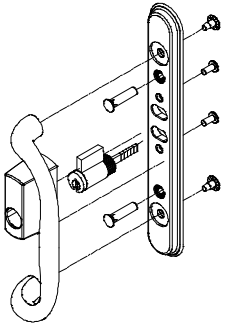
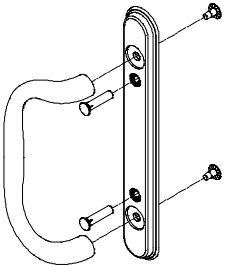
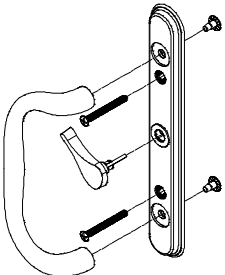
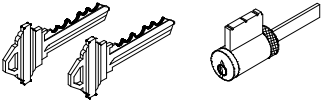
ILLUSTRATION NOT TO SCALE	DESCRIPTION	COLOR	PART NO.
	<p><b>Northfield Handle Set, Exterior Keyed</b></p> <p><i>Includes:</i></p> <ul style="list-style-type: none"> <li>1 - Exterior Handle</li> <li>1 - Keyed Cylinder</li> <li>2 - Handle Screws</li> <li>2 - Post Nuts</li> <li>1 - Exterior Escutcheon</li> </ul>	<ul style="list-style-type: none"> <li>Almond Frost</li> <li>White</li> <li>Brass PVD</li> <li>Satin Nickel PVD</li> <li>Oil Rubbed Bronze PVD</li> <li>Matte Black</li> </ul>	<ul style="list-style-type: none"> <li>10147156</li> <li>10147157</li> <li>10147158</li> <li>10147159</li> <li>10147160</li> <li>10147161</li> </ul>
	<p><b>Northfield Handle Set, Exterior Non-Keyed</b></p> <p><i>Includes:</i></p> <ul style="list-style-type: none"> <li>1 - Exterior Handle</li> <li>2 - Handle Screws</li> <li>2 - Post Nuts</li> <li>1 - Exterior Escutcheon - Non-keyed</li> </ul>	<ul style="list-style-type: none"> <li>Almond Frost</li> <li>White</li> <li>Brass PVD</li> <li>Satin Nickel PVD</li> <li>Oil Rubbed Bronze PVD</li> <li>Matte Black</li> </ul>	<ul style="list-style-type: none"> <li>11869096</li> <li>11869095</li> <li>11869097</li> <li>11869098</li> <li>11869099</li> <li>11869100</li> </ul>
	<p><b>Northfield Handle Set, Interior</b></p> <p><i>Includes:</i></p> <ul style="list-style-type: none"> <li>1 - Interior Handle</li> <li>1 - Interior Escutcheon</li> <li>1 - Thumb Turn</li> <li>2 - #8-32 2" Machine screws</li> <li>2 - Handle Screws</li> <li>1 - Instruction</li> </ul>	<ul style="list-style-type: none"> <li>Almond Frost</li> <li>White</li> <li>Brass PVD</li> <li>Satin Nickel PVD</li> <li>Oil Rubbed Bronze PVD</li> <li>Matte Black</li> </ul>	<ul style="list-style-type: none"> <li>10147151</li> <li>10147152</li> <li>10147153</li> <li>10147154</li> <li>10147155</li> <li>10147256</li> </ul>
	<p><b>Northfield Keyed Cylinder</b></p> <p><i>Includes:</i></p> <ul style="list-style-type: none"> <li>1 - Lock cylinder</li> <li>2 - Keys</li> </ul> <p><i>NOTE: For keyed alike cylinders, please contact your Marvin representative. Please supply the original order number if available.</i></p>		<p>11860977</p>

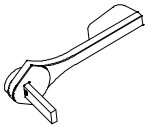
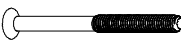


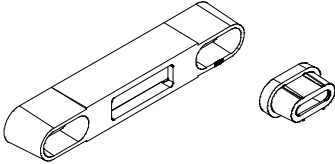
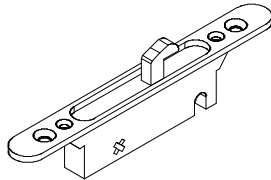
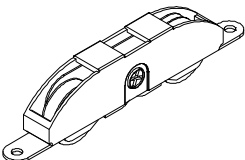
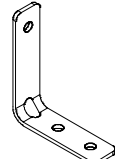
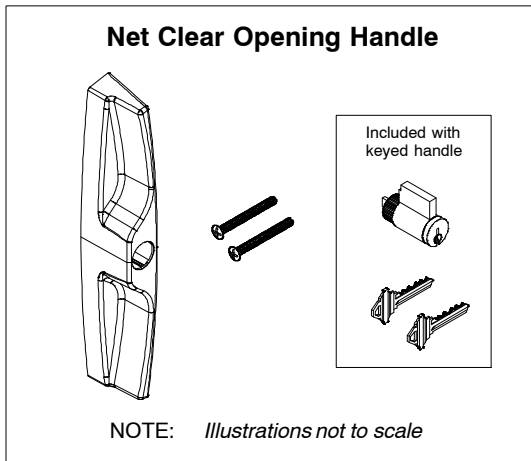
ILLUSTRATION <i>NOT TO SCALE</i>	DESCRIPTION	COLOR	PART NO.
	<b>Cambridge Lock Lever</b>	Almond Frost Stone White Brass PVD Satin Nickel PVD Oil Rubbed Bronze PVD Matte Black	10897077 10897076 10897078 10897079 10897080 10897083
	<b>Cambridge Machine Screw, #8 x 1.5"</b>	Almond Frost Stone White Brass PVD Satin Nickel PVD Oil Rubbed Bronze PVD Matte Black	11801026 11801025 11801027 11801028 11801029 11801032
	<b>Northfield Machine Screw, #10 x 1.5"</b>	Almond Frost Stone White Brass PVD Satin Nickel PVD Oil Rubbed Bronze PVD Matte Black	11883031 11883030 11883033 11883032 11886034 11886035
	<b>Cambridge Handle Screw, #10-24 x 3/8" Machine Screw</b>		11895050
	<b>Northfield Handle Screw, #10-24 x 3/8" Machine Screw</b>		11895051
	<b>Northfield Escutcheon Post Nut</b>	Almond Frost Stone White Brass Satin Nickel Oil Rubbed Bronze Matte Black	11884041 11884040 11884042 11884043 11884044 11884045
	<b>Grommet Kit, Handle</b> <i>Includes:</i> 2 – grommets  <i>NOTE: Use as adapter from #10 screws to #8 screws</i>	Black	10897082
			



ILLUSTRATION NOT TO SCALE	DESCRIPTION	COLOR	PART NO.
	<p><b>Keeper, OX/XO, OOX/XOO Kit</b> Includes: 1 - Keeper - 11100441 2 - Operator lock stops 2 - #8 x 3 " Phillips pan head screws Pearl White (11800829), Matte Black (11810830)</p>	<p>Beige Black</p>	<p>11800041 11800046</p>
	<p><b>Keeper, OXO Kit</b> Includes: 1 - Keeper - 11100441 2 - Operator lock stops 2 - #8 x 1 1/4 " Phillips panhead screws (11800122)</p>	<p>Beige Black</p>	<p>11800142 11800048</p>
	<p><b>Mortise Lock</b> includes fasteners: 2 - #8 x 1 " Phillips flathead screws (11800810)</p>		<p>11800022</p>
	<p><b>Adjustable Panel Roller</b> includes fasteners: 2 - #8 x 1 " Phillips flathead screws (11800810)</p>		<p>10820000</p>
	<p><b>Stationary Panel Bracket Kit</b> includes fasteners: 1 - #8 x 1 " Phillips panhead screws - White (11800820), Black (11800953) 1 - #8 x 3 " Phillips pan head screws Pearl White (11800829), Matte Black (11810830) 1 - #8 x 3/4 " Phillips truss head screws Pearl White (11800898), Matte Black (11800997)</p>	<p>Beige Black</p>	<p>11800010 11800012</p>

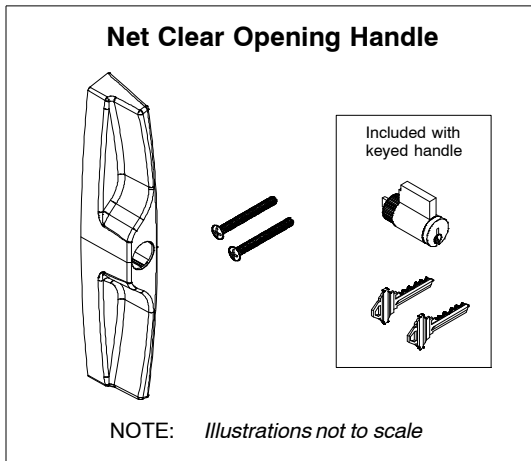


NOTE: Each kit contains one exterior handle, two fasteners, installation instructions and one label.

Cambridge	Fastener Colors				
Non Keyed Handle Kit Colors	White	Almond Frost	Black	Silver	Brass Plated
White	11810001	11810004	11810007	11810010	11810017
Almond Frost	11810002	11810005	11810008	11810011	11810018
Bronze	11810003	11810006	11810009	11810016	11810019
Matte Black	11810035	11810036	11810037	11810038	11810039

Cambridge	Fastener Colors				
Keyed Handle Kit Colors	White	Almond Frost	Black	Silver	Brass Plated
White	11820020	11820023	11820026	11820029	11820032
Almond Frost	11820021	11820024	11820027	11820030	11820033
Bronze	11820022	11820025	11820028	11820031	11820034
Matte Black	11810040	11810041	11810042	11810043	11810044

Cambridge 1 5/8" Oval Screws	White
Stone White	11801155
Almond Frost	11801156
Black	11801157
Silver	11801158
Brass Plated	11801159



NOTE: Each kit contains one exterior handle, two fasteners, installation instructions and one label.

Northfield	Fastener Colors				
Non Keyed Handle Kit Colors	White	Almond Frost	Black	Silver	Brass Plated
White	12810001	12810004	12810007	12810010	12810017
Almond Frost	12810002	12810005	12810008	12810011	12810018
Bronze	12810003	12810006	12810009	12810016	12810019
Matte Black	12810035	12810036	12810037	12810038	12810039

Northfield	Fastener Colors				
Keyed Handle Kit Colors	White	Almond Frost	Black	Silver	Brass Plated
White	12820020	12820023	12820026	12820029	12820032
Almond Frost	12820021	12820024	12820027	12820030	12820033
Bronze	12820022	12820025	12820028	12820031	12820034
Matte Black	12810040	12810041	12810042	12810043	12810044

Northfield 2" Oval Screws	White
Stone White	11897061
Almond Frost	11897062
Black	11897063
Silver	11897064
Brass Plated	11897065

When ordering replacement Sliding Patio Door parts specify:

1. Part number;
2. Description;
3. Standard or special size measurements;
4. Length of part (if applicable);
5. Color (if applicable);
6. Handing (if applicable).


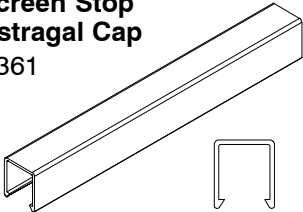
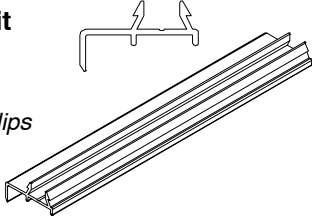
ILLUSTRATION AND DESCRIPTION							
ILLUSTRATIONS NOT TO SCALE							
<b>Spline Cap, Exterior</b> A1508 		<b>Screen Stop Astragal Cap</b> A361 		<b>Screen Stop Astragal Base Kit</b> A362 Includes: 8-10 - #8 x 2" Phillips panhead screws 			
Call Number	Length	Description / Color / Part No.					
Spline Cap (A1508)							
		Stone White	Pebble	Bronze	Evergreen	Cashmere	Ebony
68	77 1/2" (1969)	11008510	12008510	13008510	14008510	15008510	18009510
610	79 1/2" (2019)	11008610	12008610	13008610	14008610	15008610	18009610
80	93 1/2" (2375)	11000880	12000880	13000880	14000880	15000880	18000980
Lineal Only	174" (4420)	11008499	11008599	11008699	11008799	11008899	18008999
Screen Stop Astragal Cap (A361)							
		Stone White	Pebble	Bronze	Evergreen	Cashmere	Ebony
68	76 23/32" (1948)	18505101	18505102	18505103	18505104	18505105	18505107
610	79 1/2" (2019)	18506102	18506101	18506103	18506104	18506105	18506107
80	93 1/2" (2375)	18500802	18500801	18500803	18500804	18500805	18500807
Lineal Only	96" (2438)	18547696	18547596	18547796	18547869	18547969	18547496
Screen Stop Astragal Base Kit (A362)							
		Stone White	Pebble	Bronze	Evergreen	Cashmere	Ebony
68	77 17/32" (1969)	11800268	11800368	11800468	11800568	11800768	11800968
610	79 1/2" (2019)	11800461	11800561	11800961	11801061	11801161	11801261
80	93 1/2" (2375)	11801280	11801380	11801480	11801580	11801680	11801780
Lineal Only	96" (2438)	18547896	18547797	18547997	18547998	18547999	18548002

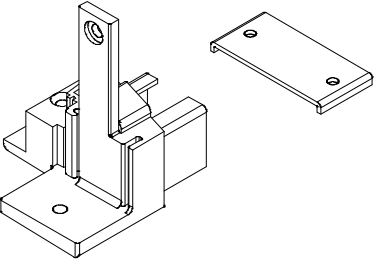
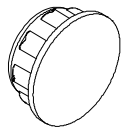
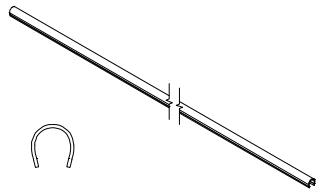
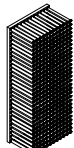
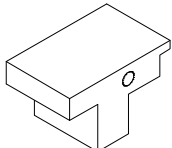
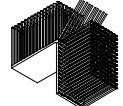
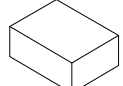
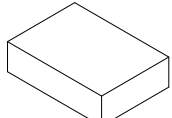
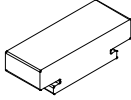
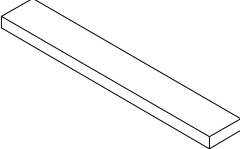
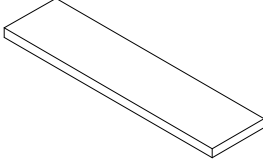
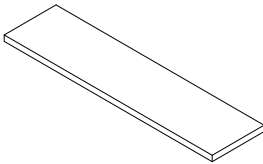
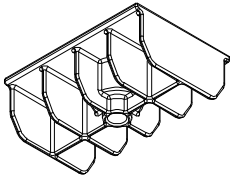
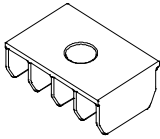
ILLUSTRATION NOT TO SCALE	DESCRIPTION	OPER./COLOR	PART NO.
	<p><b>Leveling Block End Cap</b> Includes: 1 – End cap 2 – #8 x 1" Phillips pan head screws White (11800820), Black (11800953) 1 – #8 x 1 1/2" Phillips pan head screws Beige (11800852), Black (11800962) 1 – #8 x 1" Phillips flat head screws (11800810) 1 – Stationary panel dust block 2 – Leveling block end cap dust block 1 – Leveling block end cap retainer (11850110)</p>	<p>Beige OX/OOX/OXO XO/XOO/OXO</p> <p>Black OX/OOX/OXO XO/XOO/OXO</p>	<p>11800999 11800099</p> <p>11802888 11801888</p>
	<p><b>Roller Adjustment Hole Cap</b></p>	<p>Stone White Bronze Ebony</p>	<p>156015 156020 156023</p>
	<p><b>Stainless Steel Cap, Sill</b></p>	<p>CN 50 width 56 17/32" (1436) CN 510 width 67 1/32" (1703) CN 60/ 90 OXO width 68 17/32" (1741) CN 90 OOX, XO width 104 17/32" (2655)</p>	<p>10600650 10600510 10600660 10600690</p>
	<p><b>Dust Block, Leveling Block End Cap</b></p>	<p>Beige Gray</p>	<p>10600250 10600249</p>
	<p><b>Astragal Foam Plug</b></p>	<p>White Black</p>	<p>10500880 10500889</p>
	<p><b>Stationary Panel Dust Block</b></p>	<p>Beige Gray</p>	<p>15600011 15600010</p>
	<p><b>Panel Drip Plug</b></p>		<p>10500137</p>
	<p><b>Jamb/Sill Foam Block</b></p>	<p>Beige Gray</p>	<p>10500136 10510139</p>

ILLUSTRATION NOT TO SCALE	DESCRIPTION	OPER./COLOR	PART NO.
	<b>Stationary Panel to Head Jamb Foam Block</b> <i>Usage: September 24, 2018 – present</i>	Gray	10501935
	<b>Stationary Panel to Head Jamb Foam Block</b> <i>Usage: Prior to September 24, 2018</i> <i>Available for Field Service</i>	Beige	10600500
	<b>Frame Sealant, Foam, Sill Liner</b> 1/16" x 3/8" Adhesive backed <i>Part is sold by LF – please specify length*</i>	Gray	10500142*
	<b>Leveling Block Foam Frame Sealant</b> 3/32" x 5/8"		11406212
	<b>Foam Frame Sealant</b> <i>NOTE: Adhesive one side – 100'</i> 1/8" x 3/8"	Black	10500050
	<b>Jamb Block</b> <i>For OX/XO and OOX/XOO</i>	Stone White Black	11865049 11865059
	<b>Jamb Block</b> <i>For OXO astragal only</i>	Stone White Black	11865050 11865060

When ordering replacement weatherstrip specify:

1. Quantity;
2. Profile number;
3. Part number;
4. Standard or special size measurements;
5. Length of part;
6. Description.


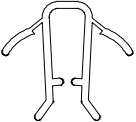
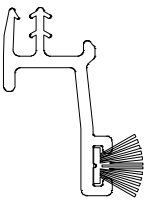
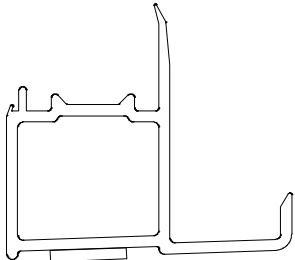
ILLUSTRATION <i>NOT TO SCALE</i>	DESCRIPTION	LENGTH	PART NO/COLOR	
			Beige	Black
	<b>Sill Liner</b> V1634 CN 50 width – XO/OX 56 17/32" (1436) CN 510 width – XO/OX 67 1/32" (1703) CN 60 width – XO/OX 68 17/32" (1741) CN 90 width – XOO/OOX/OXO 104 17/32" (2655)		11100050	11101950
	<b>Sill Liner Fasteners</b> <i>(suggested quantity 3EA for OX/XO or 4 EA for OOX, XOO and OXO configurations)</i> #8–18 x 5/8" Phillips flat head screw		Pearl White 11807175	Dark Brown 11805156
	<b>Head Jamb Weather Strip</b> V1636 (Beige) V2912 (Black) CN 50 width 56 17/32" (1436) CN 510 width 67 31/32" (1726) CN 60 width 68 17/32" (1741) CN 90 width 104 17/32" (2655)		18210050	18510050
	<b>Jamb Weather Strip</b> V1636 (Beige) V2912 (Black) CN 68 height 78 3/32" (1984) CN 610 height 80 3/32" (2034) CN 80 height 94 3/32" (2390)		18210068	18410068
	<b>Panel Seal</b> V1637 (Beige) V2903 (Black) <i>Includes: Pile weather strip</i> CN 50 width 29 13/32" (747) CN 510 width 34 21/32" (880) CN 60/90 width 35 13/32" (899)		18310050	18410050
	<b>Leveling Block Kit</b> V1639 (Beige) V2904 (Black) <i>Includes: Adhesive foam tape</i> CN 50 width 28 15/16" (735) CN 510 width 34 3/16" (868) CN 60/90 width 34 15/16" (887) CN 90 width 70 15/16" (1802)		11800050	11800350
			11801510	11803510
			11800060	11800360
			11800090	11800390

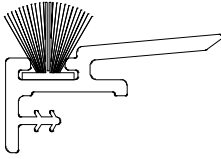
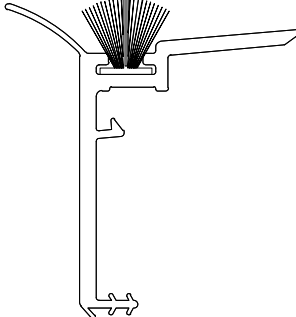
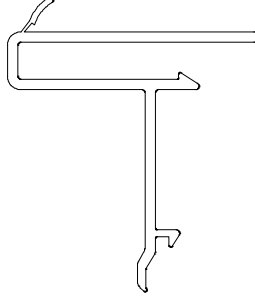
ILLUSTRATION NOT TO SCALE	DESCRIPTION	LENGTH	PART NO.	
			Beige	Black
	<b>Interlock, Operator Kit</b> V1646 (Beige) V2908 (Black) <i>Includes:</i> <i>Pile Weather Strip (11107546)</i>			
	CN 610	78 3/16" (1986)	11806610	11807710
	CN 68	76 3/16" (1935)	11800668	11807778
	CN 80	92 3/16" (2342)	11800280	11807280
	<b>Interlock, Stationary Kit</b> V2827 <i>Includes:</i> <i>Pile Weather Strip (11107546)</i>			
	CN 68 – XO	77 17/32" (1969)	11800068	11807768
	CN 68 – OX	77 17/32" (1969)	11800168	11807168
	CN 610 – XO	79 17/32" (2020)	11800061	11807761
	CN 610 – OX	79 17/32" (2020)	11810161	11817161
	CN 80 – XO	93 17/32" (2376)	11800080	11807780
CN 80 – OX	93 17/32" (2376)	11810180	11817180	
	<b>Astragal Cap, Exterior</b> V1663 (Beige) V2909 (Black)			
	CN 68 RH – OXO	77 17/32" (1969)	15000511	16000511
	CN 68 LH – OXO	77 17/32" (1969)	15000510	16000510
	CN 610 RH – OXO	79 17/32" (2020)	15000611	16000611
	CN 610 LH – OXO	79 17/32" (2020)	15000610	16000610
	CN 80 RH – OXO	93 17/32" (2375)	15000081	16000081
CN 80 LH – OXO	93 17/32" (2375)	15000080	16000080	



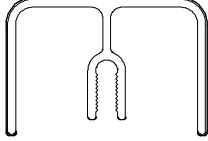
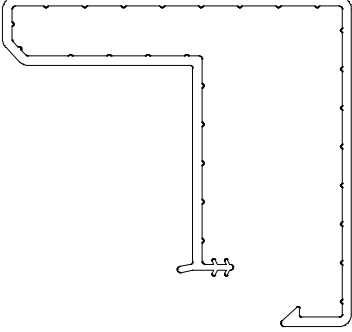
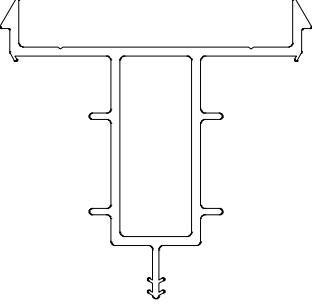
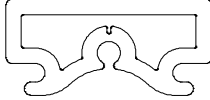
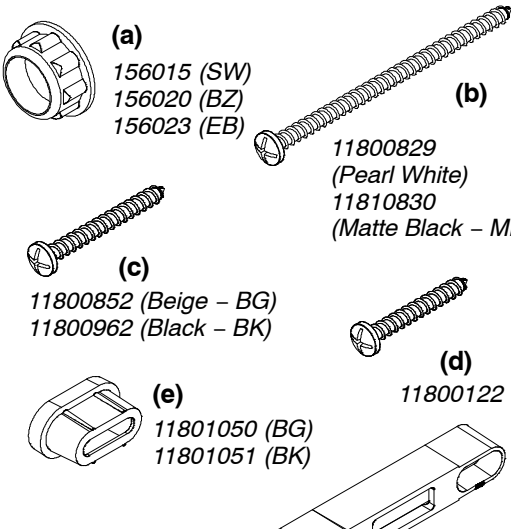
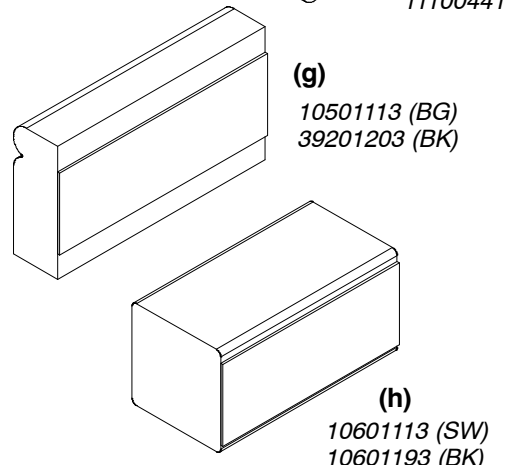
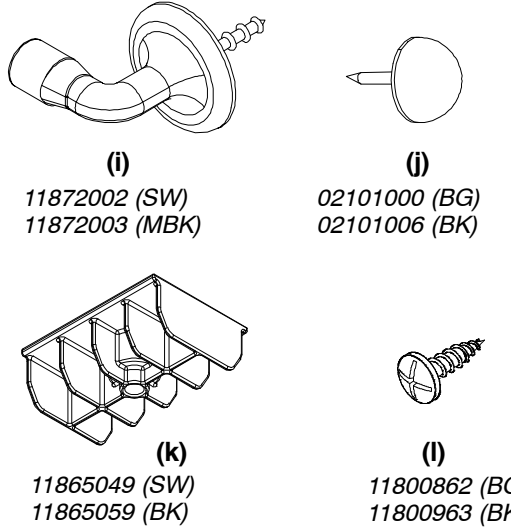
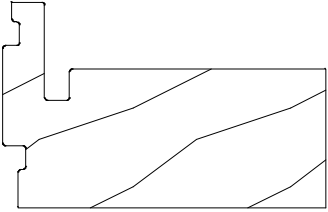
ILLUSTRATION NOT TO SCALE	DESCRIPTION	LENGTH	PART N/ COLOR		
	<p><b>Spline Cap, Interior</b> V1633</p> <p>CN 68 XOO/OOX CN 610 XOO/OOX CN 80 XOO/OOX</p>	<p>77 3/4" (1975) 79 3/4" (2026) 93 3/4" (2381)</p>	<p><b>Stone White</b> 16901510 16901610 16900180</p>	<p><b>Bronze</b> 16903510 16903610 16900380</p>	<p><b>Ebony</b> 16904510 16904610 16900480</p>
	<p><b>Astragal Cap, Interior</b> V1667 (SW) V2910 (BZ, EB)</p> <p>CN 68, OXO-RH CN 68, OXO-LH</p> <p>CN 610, OXO-RH CN 610, OXO-LH</p> <p>CN 80, OXO-RH CN 80, OXO-LH</p>	<p>77 7/8" (1979) 77 7/8" (1979)</p> <p>79 7/8" (2020) 79 7/8" (2020)</p> <p>93 7/8" (2384) 93 7/8" (2384)</p>	<p><b>Stone White</b> 15002510 15001510</p> <p>15002610 15001610</p> <p>15000280 15000180</p>	<p><b>Bronze</b> 15006510 15005510</p> <p>15006610 15005610</p> <p>15000680 15000580</p>	<p><b>Ebony</b> 15004510 15003510</p> <p>15004610 15003610</p> <p>15000480 15000380</p>
	<p><b>Stationary Panel Spline Kit</b> V1649</p> <p><i>Includes:</i> 1 - Stationary Panel Bracket 1 - Backer 16-20 - #8 x 5/8" Phillips pan head screws (11800505)</p> <p>CN 68 - XOO/OOX CN 610 - XOO/OOX CN80 - XOO/OOX</p>	<p>77 7/8" (1978) 79 7/8" (2029) 93 7/8" (2385)</p>	<p><b>Beige</b> 11801068 11800361 11800380</p>		
	<p><b>Panel Extension Block Kit</b> V2228</p> <p><i>Includes:</i> 1 - #8 x 1" Phillips panhead screw - 11800820</p> <p>CN 9080, OXO-RH CN 9080, OXO-LH CN 9080, OOX CN 9080, XOO</p>	<p>28" (711)</p>	<p><b>Natural</b> 02100028</p>		

ILLUSTRATION NOT TO SCALE	DESCRIPTION	PART NO.
 <p>(a) 156015 (SW) 156020 (BZ) 156023 (EB)</p> <p>(b) 11800829 (Pearl White) 11810830 (Matte Black – MBK)</p> <p>(c) 11800852 (Beige – BG) 11800962 (Black – BK)</p> <p>(d) 11800122</p> <p>(e) 11801050 (BG) 11801051 (BK)</p> <p>(f) 11100441</p> <p>(g) 10501113 (BG) 39201203 (BK)</p> <p>(h) 10601113 (SW) 10601193 (BK)</p> <p>(i) 11872002 (SW) 11872003 (MBK)</p> <p>(j) 02101000 (BG) 02101006 (BK)</p> <p>(k) 11865049 (SW) 11865059 (BK)</p> <p>(l) 11800862 (BG) 11800963 (BK)</p>	<p><b>OX/XO Installation Kit</b> Includes: 2 – Hole plug (a) 11 – #8 x 3" pan head screw (b) 1 – #8 x 1 1/2" pan head screw (c) 1 – #8 x 1 1/4" pan head screw (d) 2 – Door stop, keeper (e) 1 – Keeper (f) 1 – Operator stop block, sill (g) 1 – Operator stop block, header (h) 2 – thumb tack bumpers (j) 6 – jamb blocks (k) 4 – #8 x 5/8" truss head screw (l)</p> <p>NOTE: Also included with each package are installation instructions, warranty and general care instructions, installation supplement and nailing fin corner gaskets.</p>	<p><b>Stone White (SW)</b> 11800001</p> <p><b>Bronze (BZ)</b> 11800005</p> <p><b>Ebony (EB)</b> 11800004</p>
 <p>(a) 156015 (SW) 156020 (BZ) 156023 (EB)</p> <p>(b) 11800829 (Pearl White) 11810830 (Matte Black – MBK)</p> <p>(c) 11800852 (Beige – BG) 11800962 (Black – BK)</p> <p>(d) 11800122</p> <p>(e) 11801050 (BG) 11801051 (BK)</p> <p>(f) 11100441</p> <p>(g) 10501113 (BG) 39201203 (BK)</p> <p>(h) 10601113 (SW) 10601193 (BK)</p> <p>(i) 11872002 (SW) 11872003 (MBK)</p> <p>(j) 02101000 (BG) 02101006 (BK)</p> <p>(k) 11865049 (SW) 11865059 (BK)</p> <p>(l) 11800862 (BG) 11800963 (BK)</p>	<p><b>OOX/XOO Installation Kit</b> Includes: 2 – Hole plug (a) 13 – #8 x 3" pan head screw (b) 1 – #8 x 1 1/2" pan head screw (c) 1 – #8 x 1 1/4" pan head screw (d) 2 – Door stop, keeper (e) 1 – Keeper (f) 2 – Operator panel stop/bumper (i) 6 – jamb blocks (k) 4 – #8 x 5/8" truss head screw (l)</p> <p>NOTE: Also included with each package are installation instructions, warranty and general care instruction, installation supplement and nailing fin corner gaskets.</p>	<p><b>Stone White (SW)</b> 11800002</p> <p><b>Bronze (BZ)</b> 11800007</p> <p><b>Ebony (EB)</b> 11800006</p>
 <p>(a) 156015 (SW) 156020 (BZ) 156023 (EB)</p> <p>(b) 11800829 (Pearl White) 11810830 (Matte Black – MBK)</p> <p>(c) 11800852 (Beige – BG) 11800962 (Black – BK)</p> <p>(d) 11800122</p> <p>(e) 11801050 (BG) 11801051 (BK)</p> <p>(f) 11100441</p> <p>(g) 10501113 (BG) 39201203 (BK)</p> <p>(h) 10601113 (SW) 10601193 (BK)</p> <p>(i) 11872002 (SW) 11872003 (MBK)</p> <p>(j) 02101000 (BG) 02101006 (BK)</p> <p>(k) 11865049 (SW) 11865059 (BK)</p> <p>(l) 11800862 (BG) 11800963 (BK)</p>	<p><b>OXO Installation Kit</b> Includes: 2 – Hole plug (a) 9 – #8 x 3" pan head screw (b) 2 – #8 x 1 1/2" pan head screw (c) 3 – #8 x 1 1/4" pan head screw (d) 2 – Door stop, keeper (e) 1 – Keeper (f) 1 – Operator stop block, sill (g) 1 – Operator stop block, header (h) 2 – thumb tack bumpers (j) 4 – jamb blocks (k) 4 – #8 x 5/8" truss head screw (l)</p> <p>NOTE: Also included with each package are installation instructions, warranty and general care instructions, installation supplement and nailing fin corner gaskets.</p>	<p><b>Stone White (SW)</b> 11800003</p> <p><b>Bronze (BZ)</b> 11800019</p> <p><b>Ebony (EB)</b> 11800008</p>

When ordering replacement wood parts specify:

1. Part number;
2. Size;
3. Description.
4. Handing (if applicable)
5. Bare wood or white interior.

<b>ILLUSTRATION</b> <i>NOT TO SCALE</i>	<b>DESCRIPTION</b>	<b>LENGTH</b>	<b>BARE WOOD PART NO.</b>
	<b>Astragal Core</b> W9782		
	CN 68 RH, OXO	77 7/8" (1978)	31505511
	CN 68 LH, OXO	77 7/8" (1978)	31505510
	CN 610 RH, OXO	79 7/8" (2029)	31505611
	CN 610 LH, OXO	79 7/8" (2029)	31505610
	CN 80 RH, OXO	93 7/8" (2384)	31505081
CN 80 LH, OXO	93 7/8" (2384)	31505080	

Use this chart to determine sizes for replacement parts, panels and screen:

- Daylight Opening (DLO) is a measurement of the visible glass.
- Outside measurement = OM
- Sizes for Essential Sliding Patio Doors manufactured 3/17/2008 to present.

WIDTH					
Unit CN	Frame OM	Panel OM	DLO	Screen OM	Standard Lite Cut
50	59 1/2" (1511)	29 13/32" (747)	25" (635)	29 3/16" (741)	3W
510	70" (1778)	34 21/32" (880)	30 1/4" (768)	34 7/16" (875)	3W
60	71 1/2" (1816)	35 13/32" (899)	31" (787)	35 3/16" (894)	3W
90	107 1/2" (2731)	35 13/32" (899)	31" (787)	35 3/16" (894)	3W

HEIGHT (units manufactured 1/28/2019 – present)					
Unit CN	Frame OM	Panel OM	DLO	Screen OM	Standard Lite Cut
68	79 1/2" (2019)	76 29/32" (1953)	72 1/2" (1842)	77 9/32" (1963)	5H
610	81 1/2" (2070)	78 29/32" (2004)	74 1/2" (1892)	79 9/32" (2014)	5H
80	95 1/2" (2426)	92 29/32" (2360)	88 1/2" (2248)	93 9/32" (2369)	6H

HEIGHT (units manufactured until 1/28/2019)					
Unit CN	Frame OM	Panel OM	DLO	Screen OM	Standard Lite Cut
68	79 1/2" (2019)	76 29/32" (1953)	72 1/2" (1842)	77 3/4" (1975)	5H
610	81 1/2" (2070)	78 29/32" (2004)	74 1/2" (1892)	79 3/4" (2026)	5H
80	95 1/2" (2426)	92 29/32" (2360)	88 1/2" (2248)	93 3/4" (2381)	6H

#### Determining Panel Size

##### Daylight Opening to OM of Panel

Daylight Width + 4 7/16" = OM Width of Panel  
 Daylight Height + 4 7/16" = OM Height of Panel

#### Determining Screen Size

##### Daylight Opening to OM of Screen

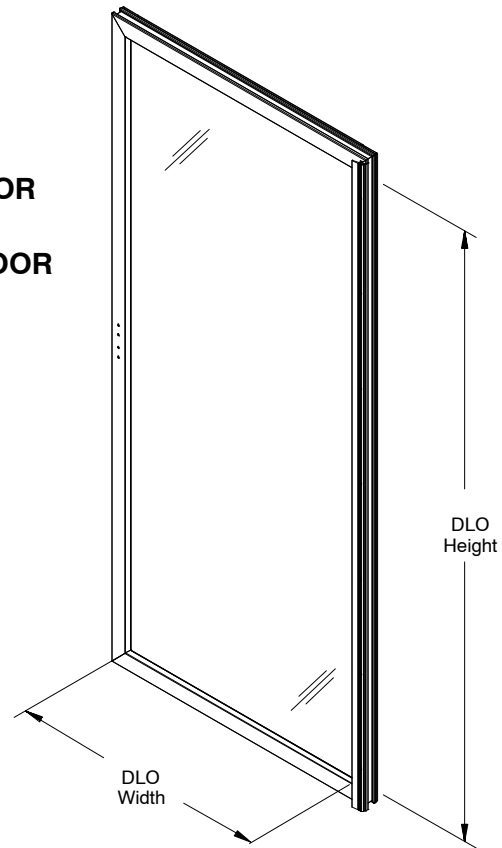
Daylight Width + 4 3/16" = OM Width of Screen  
 Daylight Height + 4 25/32" = OM Height of Screen

**ORDERING REPLACEMENT ESSENTIAL SLIDING PATIO DOOR PANELS**

To order replacement panels specify:

1. Call number or special size;
2. Operator or stationary;
3. Handing;
4. Exterior color;
5. Panel height and width;
6. Lite cut.

**EXTERIOR  
 VIEW  
 PATIO DOOR**



**ORDERING REPLACEMENT ESSENTIAL SLIDING PATIO DOOR SCREENS**

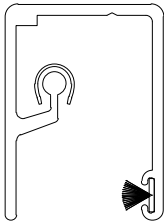
Screens are standard with a color matched aluminum surround and charcoal colored fiberglass 18 x 16 screen mesh. Determine the outside measurement of the existing screen.

To order replacement screens specify:

1. Call number or special size (if available);
2. For screens on product manufactured after 1/28/2019: If there is no existing screen from which to obtain the OM of the screen, determine the size of the screen by using the chart in the previous section or use the calculations provided. The daylight opening is the measurement of the visible glass;
3. For screens on product manufactured prior to 1/28/2019: Determine the size of the screen using the calculations provided in the previous section. The daylight opening is the measurement of the visible glass. *NOTE: When ordering a replacement screen manufactured prior to 1/28/2019, a new screen track is required and will also need to be ordered.*
4. Handing.

When ordering Sliding Patio Door replacement screen parts specify:

1. Description;
2. Part number (for CN);
3. Quantity;
4. Length of part for special size.

	<p><b>Screen Track, Head Jamb</b> A3456 Usage: 01/28/2019 – Present <i>Includes: stainless steel cap and screen track weather strip</i> <i>Recommended screws:</i> <i>#8 x 5/8" Phillips self tapping undercut truss head screws (11800862)</i> <i>CN50, CN510, CN60 uses 6 screws, and CN90 uses 9 screws</i></p>
---	--

Size	CN	Color	Part No.	Size	CN	Color	Part No.
57 57/64" (1471)	CN50	Stone White	10508250	69 57/64" (1775)	CN60	Stone White	10508260
		Pebble	10508350			Pebble	10508360
		Bronze	10508450			Bronze	10508460
		Evergreen	10508550			Evergreen	10508560
		Cashmere	10508650			Cashmere	10508660
		Ebony	10508750			Ebony	10508760
68 25/64" (1737)	CN510	Stone White	10508251	105 57/64" (2690)	CN90	Stone White	10508290
		Pebble	10508351			Pebble	10508390
		Bronze	10508451			Bronze	10508490
		Evergreen	10508551			Evergreen	10508590
		Cashmere	10508651			Cashmere	10508690
		Ebony	10508751			Ebony	10508790

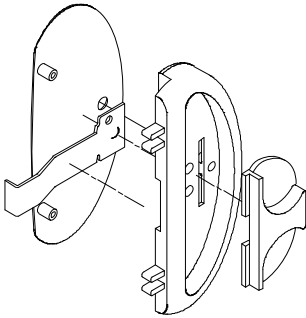
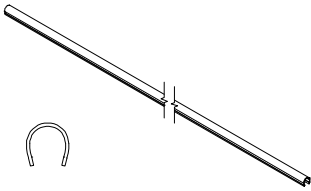
ILLUSTRATION <i>NOT TO SCALE</i>	DESCRIPTION	LENGTH/ COLOR	PART NO.
	<p><b>Screen Handle Assembly</b> Usage: 01/28/2019 – Present</p>	Black	10502586
	<p><b>Stainless Steel Cap, Screen Track</b> Usage: 01/28/2019 – Present</p>		
	<p>CN 50 width</p> <p>CN 510 width</p> <p>CN 60/ 90 OXO width</p> <p>CN 90 OOX, XOO width</p>	<p>57 57/64" (1471)</p> <p>68 25/64" (1737)</p> <p>69 57/64" (1775)</p> <p>105 57/64" (2690)</p>	<p>10600550</p> <p>10600551</p> <p>10600560</p> <p>10600590</p>

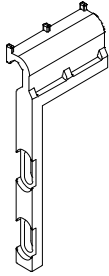
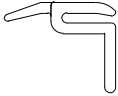

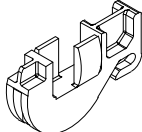
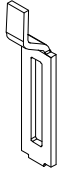
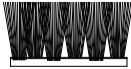
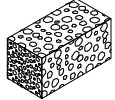
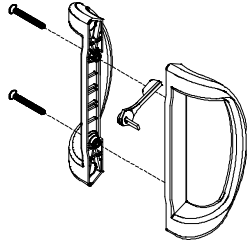
ILLUSTRATION NOT TO SCALE	DESCRIPTION	LENGTH/ COLOR	PART NO.
	<p><b>Screen Hanger, Guide</b> Usage: 01/28/2019 – Present <i>NOTE: Each panel uses 1 LH and 1 RH screen hanger.</i></p> <p><i>Recommended screws :</i> #8-15 x 3/4 Type A/Tek-2, full thread, stainless steel (11800208). 2 needed per screen hanger</p>	<p>Black</p>	<p>RH 10508193</p> <p>LH 10508192</p>
	<p><b>Screen Panel, Bottom Rail Expander, Kit</b> V3023 Usage: 01/28/2019 – Present <i>Includes screws: Qty 5</i></p>	<p>Black</p> <p>CN50 29 3/16" (741) CN510 34 7/16" (875) CN60/90 35 3/16" (894)</p>	<p>15916250 15916251 15916260</p>
	<p><b>Screen Track Weather Strip</b> Usage: 01/28/2019 – Present <i>Attach to the screen track, full length</i></p>	<p>Beige</p> <p>CN50 57 63/64" (1473) CN510 68 25/64" (1737) CN60 69 57/64" (1775) CN90 105 57/64" (2690)</p>	<p>10508150 10508510 10508160 10508190</p>
	<p><b>Screen Guide, Half Moon, Bottom Rail</b> Usage: 01/28/2019 – Present</p>	<p>Black</p>	<p>10508194</p>
	<p><b>Door Strike</b> includes fasteners: 1 – #8 x 5/8" Phillips pan head screw 11800505</p>		<p>02100963</p>
	<p><b>Screen Door Meeting Stile Dust Block</b> 17/32" x 7/8" x 1/2" <i>NOTE: Adhesive backed</i></p>	<p>Gray</p>	<p>10500161</p>
	<p><b>Screen Bumper</b> 3/4" x 3/4" x 1 3/8"</p>	<p>White</p>	<p>02540675</p>

ILLUSTRATION <i>NOT TO SCALE</i>	DESCRIPTION	COLOR	PART NO.
	<p><b>Handle Set, Non-keyed</b>  <i>Usage: Prior to February 22, 2010</i></p> <p><i>Includes:</i>            1 – handle assembly, int and ext            1 – Lock Lever            2 – Machine screws, #10 x 1.5" Phillips head</p>	<p>White            Pebble            Bronze            Evergreen            Cashmere            Ebony</p>	<p>10140050            10140051            10140052            10140053            10140054            10140055</p>



When ordering Sliding Patio Door replacement screen parts specify:

1. Description;
2. Part number (for CN);
3. Quantity;
4. Length of part for special size.

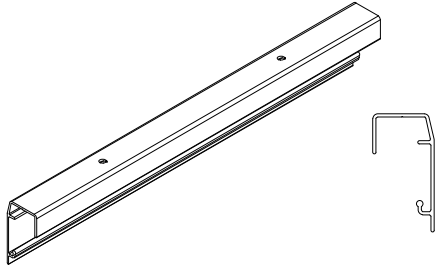
				<p><b>Screen Track</b> A1237 Usage: – 03/2008 – 01/27/2019 <i>Includes:</i> 1 – Head jamb screen track 6 – #8x5/8" Phillips self tapping undercut truss head screws 11800862</p>				
				<b>Size</b>	<b>CN</b>	<b>Color</b>	<b>Part No.</b>	<b>Size</b>
57 29/32" (1471)	CN50	Stone White	15901050		69 29/32" (1775)	CN60	Stone White	15901060
		Pebble	15902050				Pebble	15902060
		Bronze	15903050				Bronze	15903060
		Evergreen	15904050				Evergreen	15904060
		Cashmere	15905050				Cashmere	15905060
		Ebony	15906050				Ebony	15906060
68 13/32" (1737)	CN510	Stone White	15901510		105 29/32" (2690)	CN90	Stone White	15901105
		Pebble	15902510				Pebble	15902105
		Bronze	15903510				Bronze	15903105
		Evergreen	15904510				Evergreen	15904105
		Cashmere	15905510				Cashmere	15905105
		Ebony	15906510				Ebony	15906105

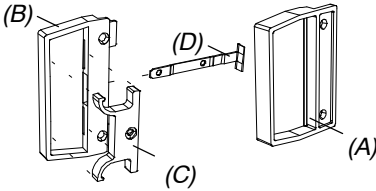
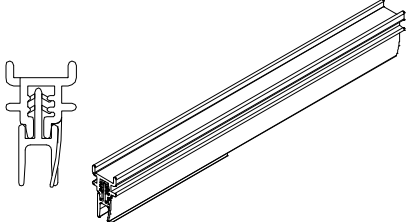
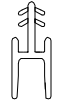
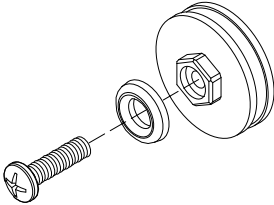

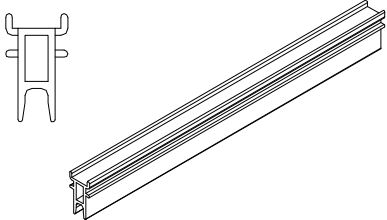
ILLUSTRATION NOT TO SCALE	DESCRIPTION	LENGTH/ COLOR	PART NO.
	<p><b>Screen Handle Assembly</b> Usage: – 03/2008 – 01/27/2019 <i>Includes:</i> 1 – Exterior handle (A) 1 – Interior handle (B) 1 – Slide (C) 1 – Latch (D) 3 – Screws 1 – Rivet</p>	Black	10150028
	<p><b>Screen Roller Guide Assembly</b> Usage: – 7/25/2012 – 01/27/2019</p>	CN 50 CN 54 CN 510 CN 60/90 CN 80	15918050 15918054 15918510 15918060 15918080
	<p><b>Screen Roller Guide</b> V2241 Usage: – 7/25/2012 – 9/17/2018</p>	Beige 2" (51)	15918002

ILLUSTRATION NOT TO SCALE	DESCRIPTION	LENGTH/ COLOR	PART NO.
	<p><b>Screen Roller Assembly</b> Usage: – 03/2008 – 01/27/2019</p> <p><i>Includes:</i> 2 – Rollers 2 – Machine screws 2 – Grommet washers</p>		11869525
	<p><b>Screen Roller Track Dust Block</b> Usage: – 03/2008 – 01/27/2019 7/8" x 7/8" x 3/16"</p> <p><i>NOTE: Adhesive backed, located behind the screen roller bar</i></p>	Gray	10500143

<b>ILLUSTRATION</b> <i>NOT TO SCALE</i>	<b>DESCRIPTION</b>	<b>LENGTH/ COLOR</b>	<b>PART NO.</b>
	<b>Screen Roller Guide</b> V014		Discontinued – Replace with Screen Roller Guide Assembly