

INTEGRITY ALL ULTREX SINGLE HUNG

Table of Contents

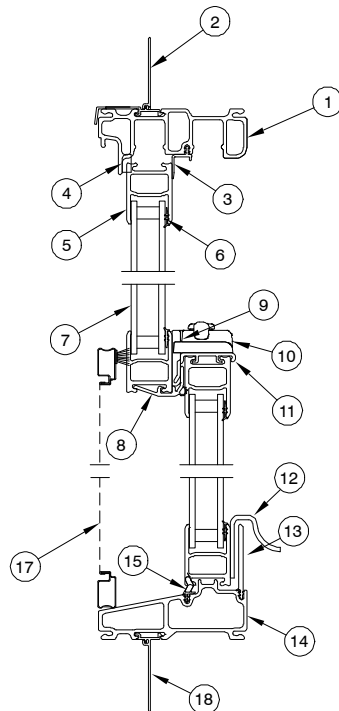
	PAGE
History	2
Part Identification – Operator	3
Part Identification – Stationary/Picture	4
Parts	
Hardware	5
Miscellaneous	7
Weather Strip and Vinyl	8
Sash and Screen Replacement	15
Screen Parts	16
Sash, Frame, Screen and DLO Charts – Equal Sash Units	17
Balance Tubes – Equal Sash	18
Balance Tubes – STC/OITC Upgrade – Equal Sash	19
Sash, Frame, Screen and DLO Charts – Cottage Units	20
Balance Tubes – Cottage Units	21
Balance Tubes – STC/OITC Upgrade – Cottage Units	22
Sash, Frame, Screen and DLO Charts – Reverse Cottage Sash Units	23
Balance Tubes – Reverse Cottage Sash Units	24
Balance Tubes – STC/OITC Upgrade – Reverse Cottage Sash Units	25
Balance Tubes – Special Size Units	26
Obsolete Parts	29
Obsolete Weather Strip and Vinyl	31
Obsolete Screen Parts	35

ATTENTION:

- Specification and technical data are subject to change without notice.
- Numbers listed in parentheses () are metric equivalents in millimeters rounded to the nearest whole number.

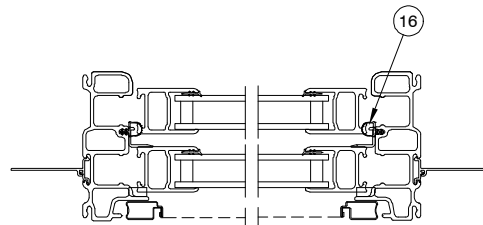
PRODUCED	UNIT TYPE	FEATURES OR CHANGES	DISCONTINUED
April 2006	Single Hung	Unit features 3/4" double strength insulating Low E II w/argon. GBGs are available in White, and Pebble Gray. 2" jambs with a 4 9/16" and 6 9/16" extensions. Available with factory applied sheet rock return and field applied J-channel. White interior only with white hardware. Pebble Gray and Stone White Ultrex exteriors.	Present
September 2006	Single Hung	V1532 sill liner replaced with V1552 and sill liner seals. Sash lift redesigned.	Present
	Single Hung	Prairie GBG Lite cuts made available for the All Ultrex Series products. See Product Bulletin 69 for more details.	Present
March 2007	Single Hung	Bronze exterior introduced. Original sash stop replaced with stop designed for the new Double Hung (effective March 26, 2007).	Present
November 2007	Single Hung	Evergreen exteriors introduced. V1143 and V1152 frame weather strip changed from gray to beige. V1472 leveling block changed to V1562.	Present
March 2008	Single Hung	Cashmere exteriors introduced March 17, 2008.	Present
October 2008	Single Hung	CN28 introduced.	Present
March 2009	Single Hung	Frame change to Double Hung profile. Ebony exteriors introduced.	Present
May 2009	Single Hung	LoE ³ 366™ glass option introduced.	Present
February 2010	Single Hung	Introduced new hardware finishes: Oil Rubbed Bronze (ORBZ), Satin Nickel (SN) PVD; Brass PVD (BS)	Present
June 2011	Single Hung	Increased frame weather strip (.328") and modified the sash hanger with new dust block.	Present
August 2011	Single Hung	Sill weather strip V1992 replaced with V2099	Present
April 2012	Single Hung	4/30/12 IFDH and IFSH are now available with the unequal sash option.	Present
October 2012	Single Hung	October 29, 2012: Introduced All Ultrex Expanded Sizes and Mulls.	Present
August 2013	Single Hung	August 26, 2013: Added new cam lock and keeper and forced entry clip, Additional CN 60 and 66 heights added to the Cottage offerings.	Present
October 2013	Single Hung	October 28, 2013: Discontinued the optional vent stop option for limiting sash travel and venting. Added Window Opening Control Device (WOCD); offers sash limits and venting option. Bottom sash tilt latch was slightly modified and works on all units manufactured from 9–2006 to present.	Present
February 2015	Single Hung	February 23, 2015 Introduced a new drip cap with nailing fin for All Ultrex	Present
February 2017	Single Hung	February 27, 2017 Implemented redesign on All Ultrex Sliding Windows. V1541 weather strip was replaced by V1143.	Present
December 2017	Single Hung	December 18, 2017 Added availability of customer specified lite cut configurations for SDL GBG. To include allowing any color GBG to the exterior only of standard and special sized units.	Present
February 2018	Single Hung	Introduced Bronze and Ebony interior option. Standardized Ebony exterior from Integrity Ebony to Marvin Ebony.	Present
October 2018	Single Hung	October 29, 2018: Low E3 ERS glass type was added.	Present
December 2018	Single Hung	December 17, 2018: Introduced textured glass types: Reed, Narrow Reed, Rain, Glue Chip and Frost and also colored glass types: Clear, Bronze, Gray and Green.	Present
January 2019	Single Hung	January 28, 2019: Screen frame was updated.	Present

SINGLE HUNG OPERATOR



**Head Jamb
and Sill Detail**

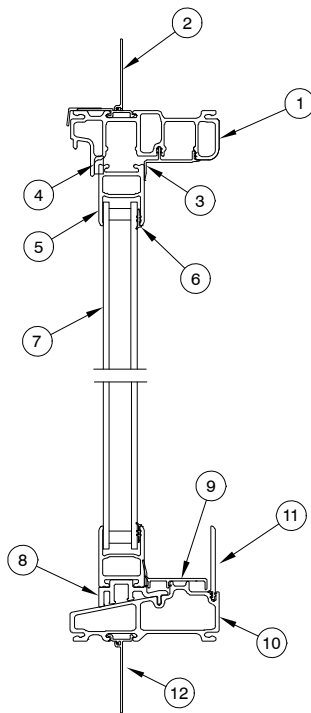
1. Frame
2. Nailing Fin w/Drip Cap
3. Parting Stop
4. Foam Tape
5. Sash
6. Vinyl Glazing Boot
7. Insulating Glass
8. Sash Cover – Top
9. Sash Keeper
10. Sash Lock
11. Sash Cover – Bottom
12. Sash Lift
13. Sill Liner
14. Sill
15. Sill Weather Strip
16. Frame Weather Strip
17. Screen
18. Nailing Fin



Jamb Detail

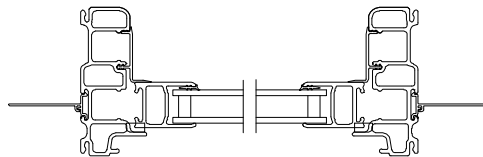
NOTE: Not to scale; specifications subject to change without notice.

**SINGLE HUNG
STATIONARY – PICTURE**



1. Frame
2. Nailing Fin w/Drip Cap
3. Head Jamb/Jamb Stop
4. Foam Tape
5. Sash
6. Vinyl Glazing Boot
7. Insulated Glass
8. Leveling Block
9. Sill Filler
10. Sill
11. Sill Liner
12. Nailing Fin

**Head Jamb
and Sill Detail**



Jamb Detail

NOTE: Not to scale; specifications subject to change without notice.

When ordering replacement Integrity Single Hung hardware specify:

1. Type of unit;
2. Part number;
3. Description.

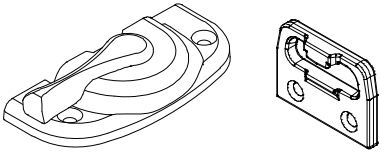

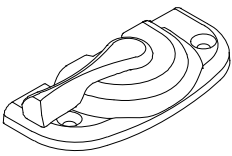
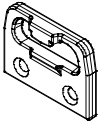
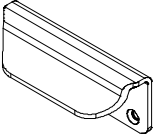
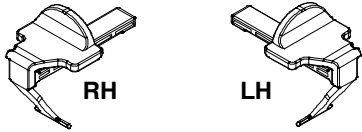
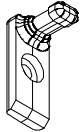
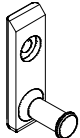
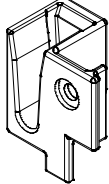

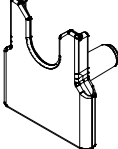
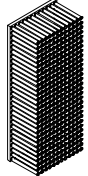
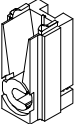
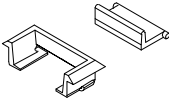
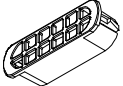
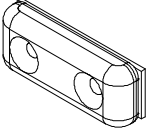
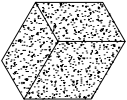
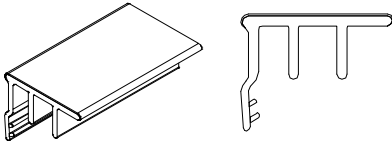
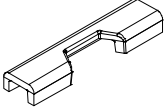
ILLUSTRATION <i>NOT TO SCALE</i>	DESCRIPTION	OPER./COLOR	PART NO.
	<p>Cam Lock and Keeper Usage: 8/26/2013 – present includes: 1 – Lock 1 – Keeper 4 – #6 x 7/8" Phillips flat head screws</p>	<p>LH Stone White (SW) Almond Frost (AF) Brass (BS) Satin Nickel (SN) Oil Rubbed Bronze (ORBZ) Matte Black (MB)</p>	<p>11800922 11800924 11800926 11800928 11800930 11800935</p>
 <p>NOTE: 1 kit per lock</p>	<p>Non-operable Cam Lock Kit includes: 1 – Sash cam lock limiter 1 – #6 x 1 1/4" Torx pan head screws 1 – Warning label 1 – Instruction</p>	<p>Stone White (SW) Almond Frost (AF) Brass (BS) Satin Nickel (SN) Oil Rubbed Bronze (ORBZ) Matte Black (MB)</p>	<p>11880480 11880481 11880482 11880483 11880484 11880485</p>
	<p>Cam Lock Cam Lock Replacement Screws #6 x 1 1/2" Flat head screw Suggested quantity-2 SW (11800158), AF (11800163), BS (11800164), SN (11800165), ORBZ (11800166) NOTE: ORBZ used for ORBZ and MB</p>	<p>LH Stone White (SW) Almond Frost (AF) Brass (BS) Satin Nickel (SN) Oil Rubbed Bronze (ORBZ) Matte Black (MB)</p>	<p>10824022 10824024 10824026 10824028 10824030 10824034</p>
	<p>Keeper Keeper Replacement Screws 2-#6 x 7/8" Phillips flat head screws NOTE: ORBZ used for ORBZ and MB Keeper Suggested quantity-2 SW (11800158), AF (11800163), BS (11800164), SN (11800165), ORBZ (11800166) NOTE: ORBZ used for ORBZ and MB</p>	<p>Stone White (SW) Almond Frost (AF) Brass (BS) Satin Nickel (SN) Oil Rubbed Bronze (ORBZ) Matte Black (MB)</p>	<p>10819040 10819080 10819050 10819060 10819070 10819090</p>
	<p>Sash Lift Sash Lift Replacement Screws #6 x 7/8" Phillips flat head screws Suggested quantity-2 SW (11800158), ORBZ (11800166) NOTE: ORBZ used for ORBZ and MB</p>	<p>Stone White Bronze Ebony</p>	<p>11867807 11867809 11867808</p>

ILLUSTRATION NOT TO SCALE	DESCRIPTION	OPER./COLOR	PART NO.
	<p>Bottom Sash Tilt Latch Usage: 9/2006 – present Includes: 1 – Tilt latch</p>	<p>Bronze LH Bronze RH Stone White LH Stone White RH Ebony LH Ebony RH</p>	<p>11860797 11860796 11860077 11860076 11860799 11860798</p>
	<p>Bottom Sash Tilt Pin includes: 1 – Tilt pin 1 – #8 x 5/8" Phillips pan head screw</p>	<p>Black</p>	<p>11812141</p>
	<p>Top Sash Tilt Pin Usage: 3/2009 – present Top Sash Tilt Pin Screws #8 x 5/8" Phillips pan head screw (11800821)</p>	<p>Black</p>	<p>11500034</p>
	<p>Stationary Sash Hanger includes: 1 – Hanger 1 – Rivets NOTE: If replacing on product manufactured prior to 5/31/11, you must replace both sash hangers, parting stop and jamb weather strip.</p>	<p>Black RH Black LH</p>	<p>11500432 11500433</p>
	<p>Sash Hanger Gasket</p>	<p>Beige</p>	<p>10500663</p>
	<p>Stationary Sash Hanger Usage: 4/2006 – 3/2009 includes: 1 – Hanger 1 – #8 x 1/2" Phillips pan head screw</p>	<p>Black</p>	<p>10500038</p>

When ordering replacement Integrity Single Hung parts specify:

1. Type of unit;
2. Part number;
3. Description.

ILLUSTRATION NOT TO SCALE	DESCRIPTION	OPER./COLOR	PART NO.
	Check Rail Dust Block <i>Usage: 3/2009 – present</i> 1/4" x 1 3/8" adhesive fabric backed	Gray	10500049
	Balance Tube Clutch	Beige Non-handed	105530
	Weep Cover and Flap <i>Usage: 2/27/2017 – present</i> <i>NOTE: These parts come pre-assembled.</i>	Stone White Pebble Bronze Ebony Evergreen Cashmere	10506722 10506723 10506724 10506727 10506725 10506726
	Drain Cover <i>Usage: 02/27/2017 – present</i>	White Black	10506704 10506733
	Sash Limiter Kit <i>includes:</i> 2 – Limiter 4 – #8-18 x 5/8" PH, FH, SS 2 – #6 x 1/2" Torx head screw (11810109) 1 – Warning label 1 – Instruction	White Matte Black	11880080 11880980
	Balance Tube Foam Plug <i>Usage: 8/26/2013 – present</i> 3/4" x 3/4" x 1/2"	White	10500104
	Bottom Sash Stop V2204 <i>Usage: 8/26/2013 – present</i>	2 1/32" (52) Lineal – 144" (3658) 2 1/32" (52) Lineal 144" (3658)	Black Black White White
	Forced Entry Clip <i>Usage: August 26, 2013 – present.</i>		11860289
	Dow Corning™ 1199 Silicone	Clear	11407092

When ordering replacement Integrity Single Hung weather strip and vinyl parts specify:

1. Description;
2. Profile number;
3. Part number;
4. Quantity,
5. Standard or custom size;
6. Equal sash, Cottage, or Reverse Cottage unit;
7. Length of part.

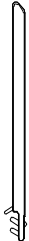
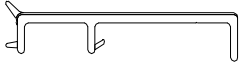
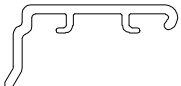
ILLUSTRATION <i>NOT TO SCALE</i>	DESCRIPTION	LENGTH	Stone White PART NO.	Bronze PART NO.	Ebony PART NO.
	Sill Liner V2697 SW V2846 BZ/EB <i>Usage: 1/09/17 – present</i>				
	CN16	16 23/32" (425)	31511316	31511016	31511116
	CN20	22 23/32" (577)	31511320	31511020	31511120
	CN26	28 23/32" (730)	31511326	31511026	31511126
	CN28	30 23/32" (781)	31511328	31511028	31511128
	CN30	34 23/32" (882)	31511330	31511030	31511130
	CN36	40 23/32" (1035)	31511336	31511036	31511136
	CN40	46 23/32" (1187)	31511340	31511040	31511140
	CN50	58 23/32" (1492)	31511350	31511050	31511150
	CN60	70 23/32" (1797)	31511360	31511060	31511160
	Lineal	96" (2438)	31511396	31511096	31511196
	Sill Filler – Picture/Transom V2844 <i>Usage: 2/27/17 – present</i>				
	CN16	15 3/8" (391)	31512416	31512516	31512616
	CN20	21 3/8" (543)	31512420	31512520	31512620
	CN26	27 3/8" (695)	31512426	31512526	31512626
	CN28	29 3/8" (746)	31512428	31512528	31512628
	CN30	33 3/8" (848)	31512430	31512530	31512630
	CN36	39 3/8" (1000)	31512436	31512536	31512636
	CN40	45 3/8" (1153)	31512440	31512540	31512640
	CN50	57 3/8" (1457)	31512450	31512550	31512650
	CN60	69 3/8" (1762)	31512460	31512560	31512660
	Lineal	144" (3658)	31512499	31512599	31512699
	Sash Cover – Bottom Single Lock V1509				
	CN16	15 1/4" (387)	17043718	15919416	15919316
	CN20	21 1/4" (540)	17043724	15919420	15919320
	CN26	27 1/4" (692)	17043730	15919426	15919326
	Sash Cover – Bottom Double Lock V1509				
	CN28	29 1/4" (743)	17043833	15919728	15919228
	CN30	33 1/4" (845)	17043836	15919730	15919230
	CN36	39 1/4" (997)	17043842	15919736	15919236
	CN40	45 1/4" (1149)	17043848	15919740	15919240

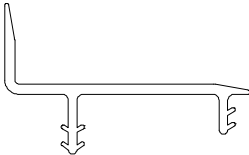
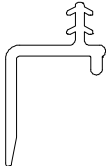
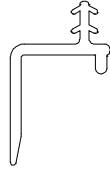
ILLUSTRATION <i>NOT TO SCALE</i>	DESCRIPTION	LENGTH	Stone White PART NO.	Bronze PART NO.	Ebony PART NO.																																																																																									
	Stationary Parting Stop Head Jamb V1405																																																																																													
	<table border="0"> <tr><td>CN16</td><td>15 7/16" (392)</td><td>22000516</td><td>23000716</td><td>23000616</td></tr> <tr><td>CN20</td><td>21 7/16" (545)</td><td>22000520</td><td>23000720</td><td>23000620</td></tr> <tr><td>CN26</td><td>27 7/16" (697)</td><td>22000526</td><td>23000726</td><td>23000626</td></tr> <tr><td>CN28</td><td>29 7/16" (748)</td><td>22000528</td><td>23000728</td><td>23000628</td></tr> <tr><td>CN30</td><td>33 7/16" (773)</td><td>22000530</td><td>23000730</td><td>23000630</td></tr> <tr><td>CN36</td><td>39 7/16" (1001)</td><td>22000536</td><td>23000736</td><td>23000636</td></tr> <tr><td>CN40</td><td>45 7/16" (1154)</td><td>22000540</td><td>23000740</td><td>23000640</td></tr> <tr><td>CN50</td><td>57 7/16" (1459)</td><td>22000550</td><td>23000750</td><td>23000650</td></tr> <tr><td>CN60</td><td>69 7/16" (1764)</td><td>22000560</td><td>23000760</td><td>23000660</td></tr> </table>	CN16	15 7/16" (392)	22000516	23000716	23000616	CN20	21 7/16" (545)	22000520	23000720	23000620	CN26	27 7/16" (697)	22000526	23000726	23000626	CN28	29 7/16" (748)	22000528	23000728	23000628	CN30	33 7/16" (773)	22000530	23000730	23000630	CN36	39 7/16" (1001)	22000536	23000736	23000636	CN40	45 7/16" (1154)	22000540	23000740	23000640	CN50	57 7/16" (1459)	22000550	23000750	23000650	CN60	69 7/16" (1764)	22000560	23000760	23000660																																																
CN16	15 7/16" (392)	22000516	23000716	23000616																																																																																										
CN20	21 7/16" (545)	22000520	23000720	23000620																																																																																										
CN26	27 7/16" (697)	22000526	23000726	23000626																																																																																										
CN28	29 7/16" (748)	22000528	23000728	23000628																																																																																										
CN30	33 7/16" (773)	22000530	23000730	23000630																																																																																										
CN36	39 7/16" (1001)	22000536	23000736	23000636																																																																																										
CN40	45 7/16" (1154)	22000540	23000740	23000640																																																																																										
CN50	57 7/16" (1459)	22000550	23000750	23000650																																																																																										
CN60	69 7/16" (1764)	22000560	23000760	23000660																																																																																										
	Parting Stop Head Jamb V1311																																																																																													
	<table border="0"> <tr><td>CN16</td><td>15 37/64" (396)</td><td>17012618</td><td>17034618</td><td>17035618</td></tr> <tr><td>CN20</td><td>21 37/64" (548)</td><td>17012624</td><td>17034624</td><td>17035624</td></tr> <tr><td>CN26</td><td>27 37/64" (700)</td><td>17012630</td><td>17034631</td><td>17035630</td></tr> <tr><td>CN28</td><td>29 37/64" (751)</td><td>17012633</td><td>17034633</td><td>17035633</td></tr> <tr><td>CN30</td><td>33 37/64" (853)</td><td>17012636</td><td>17034636</td><td>17035636</td></tr> <tr><td>CN36</td><td>39 37/64" (1005)</td><td>17012642</td><td>17034642</td><td>17035642</td></tr> <tr><td>CN40</td><td>45 37/64" (1158)</td><td>17012648</td><td>17034648</td><td>17035648</td></tr> </table> <table border="0"> <tr><td>CN20</td><td>10 11/32" (263)</td><td>17027724</td><td>17038824</td><td>17039924</td></tr> <tr><td>CN26</td><td>13 11/32" (339)</td><td>17027730</td><td>17038830</td><td>17039930</td></tr> <tr><td>CN30</td><td>16 11/32" (415)</td><td>17027736</td><td>17038836</td><td>17039936</td></tr> <tr><td>CN36</td><td>19 11/32" (491)</td><td>17027742</td><td>17038842</td><td>17039942</td></tr> <tr><td>CN40</td><td>22 11/32" (568)</td><td>17027748</td><td>17038848</td><td>17039948</td></tr> <tr><td>CN46</td><td>25 11/32" (644)</td><td>17027754</td><td>17038854</td><td>17039954</td></tr> <tr><td>CN50</td><td>28 11/32" (720)</td><td>17027760</td><td>17038860</td><td>17039960</td></tr> <tr><td>CN56</td><td>31 11/32" (796)</td><td>17027766</td><td>17038866</td><td>17039966</td></tr> <tr><td>CN60</td><td>34 11/32" (872)</td><td>17027772</td><td>17038872</td><td>17039972</td></tr> <tr><td>CN66</td><td>37 11/32" (949)</td><td>17027778</td><td>17038878</td><td>17039978</td></tr> <tr><td>Lineal</td><td>96" (2438)</td><td>17000696</td><td>17034696</td><td>17035696</td></tr> </table>	CN16	15 37/64" (396)	17012618	17034618	17035618	CN20	21 37/64" (548)	17012624	17034624	17035624	CN26	27 37/64" (700)	17012630	17034631	17035630	CN28	29 37/64" (751)	17012633	17034633	17035633	CN30	33 37/64" (853)	17012636	17034636	17035636	CN36	39 37/64" (1005)	17012642	17034642	17035642	CN40	45 37/64" (1158)	17012648	17034648	17035648	CN20	10 11/32" (263)	17027724	17038824	17039924	CN26	13 11/32" (339)	17027730	17038830	17039930	CN30	16 11/32" (415)	17027736	17038836	17039936	CN36	19 11/32" (491)	17027742	17038842	17039942	CN40	22 11/32" (568)	17027748	17038848	17039948	CN46	25 11/32" (644)	17027754	17038854	17039954	CN50	28 11/32" (720)	17027760	17038860	17039960	CN56	31 11/32" (796)	17027766	17038866	17039966	CN60	34 11/32" (872)	17027772	17038872	17039972	CN66	37 11/32" (949)	17027778	17038878	17039978	Lineal	96" (2438)	17000696	17034696	17035696			
CN16	15 37/64" (396)	17012618	17034618	17035618																																																																																										
CN20	21 37/64" (548)	17012624	17034624	17035624																																																																																										
CN26	27 37/64" (700)	17012630	17034631	17035630																																																																																										
CN28	29 37/64" (751)	17012633	17034633	17035633																																																																																										
CN30	33 37/64" (853)	17012636	17034636	17035636																																																																																										
CN36	39 37/64" (1005)	17012642	17034642	17035642																																																																																										
CN40	45 37/64" (1158)	17012648	17034648	17035648																																																																																										
CN20	10 11/32" (263)	17027724	17038824	17039924																																																																																										
CN26	13 11/32" (339)	17027730	17038830	17039930																																																																																										
CN30	16 11/32" (415)	17027736	17038836	17039936																																																																																										
CN36	19 11/32" (491)	17027742	17038842	17039942																																																																																										
CN40	22 11/32" (568)	17027748	17038848	17039948																																																																																										
CN46	25 11/32" (644)	17027754	17038854	17039954																																																																																										
CN50	28 11/32" (720)	17027760	17038860	17039960																																																																																										
CN56	31 11/32" (796)	17027766	17038866	17039966																																																																																										
CN60	34 11/32" (872)	17027772	17038872	17039972																																																																																										
CN66	37 11/32" (949)	17027778	17038878	17039978																																																																																										
Lineal	96" (2438)	17000696	17034696	17035696																																																																																										

ILLUSTRATION
NOT TO SCALE



Parting Stop Jamb – WOCD
V1311
Equal Sash

DESCRIPTION	LENGTH	Stone White		Bronze		Ebony	
		LH PART NO.	RH PART NO.	LH PART NO.	RH PART NO.	LH PART NO.	RH PART NO.
CN20	10 11/32" (263)	17121724	17121725	17121824	17121825	17131924	17131925
CN26	13 11/32" (339)	17121730	17121731	17121830	17121831	17121930	17121931
CN30	16 11/32" (415)	17121736	17121737	17121836	17121837	17121936	17121937
CN36	19 11/32" (491)	17121742	17121743	17121842	17121843	17121942	17121943
CN40	22 11/32" (568)	17121748	17121749	17121848	17121849	17121948	17121949
CN46	25 11/32" (644)	17121754	17121755	17121854	17121855	17121954	17121955
CN50	28 11/32" (720)	17121760	17121761	17121860	17121861	17121960	17121961
CN56	31 11/32" (796)	17121766	17121767	17121866	17121867	17121966	17121967
CN60	34 11/32" (872)	17121772	17121773	17121872	17121873	17121972	17121973
CN66	37 11/32" (949)	17121778	17121779	17121878	17121879	17121978	17121979
	*40 11/32" (1025)	17121782	17121783	17121882	17121883	17121982	17121983
	*43 11/32" (1101)	17121786	17121787	17121886	17121887	17121986	17121987

* Reverse Cottage sizes only


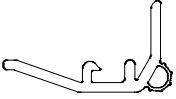
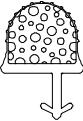
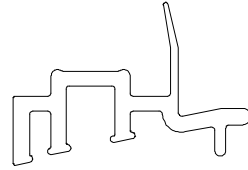
ILLUSTRATION NOT TO SCALE	DESCRIPTION	LENGTH	Beige PART NO.	Black PART NO.
	Sill Weather Strip V2099			
	CN16	15 1/4" (387)	17001116	11811016
	CN20	21 1/4" (540)	17001120	11811020
	CN26	27 1/4" (692)	17001126	11811026
	CN28	29 1/4" (743)	17001128	11811028
	CN30	33 1/4" (845)	17001130	11811030
	CN36	39 1/4" (997)	17001136	11811036
	CN40 Lineal	45 1/4" (1149) 96 1/4" (2438)	17001140 17011199	11811040 11811096
	Sash Cover – Top V1749			
	CN16	15 1/4" (387)	17005916	15919016
	CN20	21 1/4" (540)	17005920	15919020
	CN26	27 1/4" (692)	17005926	15919026
	CN28	29 1/4" (743)	17005928	15919028
	CN30	33 1/4" (845)	17005930	15919030
	CN36 CN40	39 1/4" (997) 45 1/4" (1149)	17005936 17005940	15919036 15919040
	Frame Weather Strip – Bottom Jamb V1143 Equal Sash			
	CN20	10 7/16" (265)	15906610	15906710
	CN26	13 7/16" (341)	15906613	15906713
	CN30	16 7/16" (418)	15906616	15906716
	CN36	19 7/16" (494)	15906619	15906719
	CN40	22 7/16" (570)	15906622	15906722
	CN46	25 7/16" (646)	15906625	15906725
	CN50	28 7/16" (722)	15906628	15906728
	CN56	31 7/16" (799)	15906631	15906731
	CN60	34 7/16" (875)	15906634	15906734
	CN66	37 7/16v(951)	15906637	15906737
	Lineal	96" (2438)	15906699	15906799

ILLUSTRATION AND DESCRIPTION
ILLUSTRATION NOT TO SCALE



Leveling Block
V2070 (PVC)
V2859 (CPVC)
Usage: 05/2011 – present
Includes:
2 – #7 x 3/4" screw

CN	LENGTH	PART NO.				
		Stone White/ Stone White V2070	Pebble/ Stone White V2070	Cashmere/ Stone White V2070		
16	15 1/4" (387)	11201116	11201216	11201516		
20	21 1/4" (540)	11201120	11201220	11201520		
26	27 1/4" (692)	11201126	11201226	11201526		
28	29 1/4" (743)	11201128	11201228	11201528		
30	33 1/4" (845)	11201130	11201230	11201530		
36	39 1/4" (870)	11201136	11201236	11201536		
40	45 1/4" (1149)	11201140	11201240	11201540		
50	57 1/4" (1454)	11201150	11201250	11201550		
Lineal	96" (2438)	11201199	11201299	11201599		
CN	LENGTH	Evergreen/ Stone White V2859	Ebony/ Stone White V2859	Bronze/ Stone White V2859	Bronze/ Bronze V2859	Ebony/ Ebony V2859
16	15 1/4" (387)	11306116	11307116	11305116	11308116	11309116
20	21 1/4" (540)	11306120	11307120	11305120	11308120	11309120
26	27 1/4" (692)	11306126	11307126	11305126	11308126	11309126
28	29 1/4" (743)	11306128	11307128	11305128	11308128	11309128
30	33 1/4" (845)	11306130	11307130	11305130	11308130	11309130
36	39 1/4" (870)	11306136	11307136	11305136	11308136	11309136
40	45 1/4" (1149)	11306140	11307140	11305140	11308140	11309140
50	57 1/4" (1454)	11306150	11307150	11305150	11308150	11309150
Lineal	96" (2438)	11306196	11307196	11305196	11308196	11309196



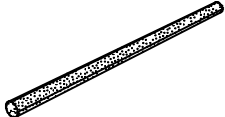
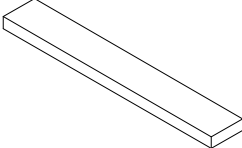
ILLUSTRATION NOT TO SCALE	DESCRIPTION	LENGTH/COLOR	PART NO.	
	Balance Tube Cover V2870	Black		
			9 1/16" (230)	11002809
			10 1/16" (255)	11002810
			11 1/16" (281)	11002811
			12 1/16" (306)	11002812
			13 1/16" (331)	11002813
			14 1/16" (357)	11002814
			15 1/16" (382)	11002815
			16 1/16" (408)	11002816
			17 1/16" (433)	11002817
			18 1/16" (458)	11002818
			19 1/16" (484)	11002819
			20 1/16" (509)	11002820
			21 1/16" (535)	11002821
			22 1/16" (560)	11002822
			23 1/16" (585)	11002823
			24 1/16" (611)	11002824
			25 1/16" (636)	11002825
			26 1/16" (662)	11002826
			27 1/16" (687)	11002827
			28 1/16" (712)	11002828
			29 1/16" (738)	11002829
			30 1/16" (763)	11002830
			31 1/16" (789)	11002831
			32 1/16" (814)	11002832
			33 1/16" (839)	11002833
			34 1/16" (865)	11002834
			35 1/16" (890)	11002835
			36 1/16" (916)	11002836
			37 1/16" (941)	11002837
			38 1/16" (966)	11002838
			39 1/16" (992)	11002839
			40 1/16" (1017)	11002840
			41 1/16" (1043)	11002851
			42 1/16" (1068)	11002842
			43 1/16" (1093)	11002843

ILLUSTRATION NOT TO SCALE	DESCRIPTION	LENGTH	COLOR	PART NO.
	Half Screen Pile Weather Strip	12" (305)		15619399*
	Foam Rope V1244 – 7/32" (6) diameter	50' (15240)		15910050
	Foam Tape 1/4" x 1/8"	50' (15240)	Gray	11406228

* Part Number is sold by LF.

Sash ordering information provide:

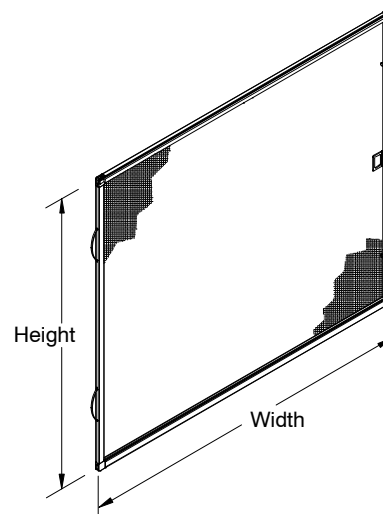
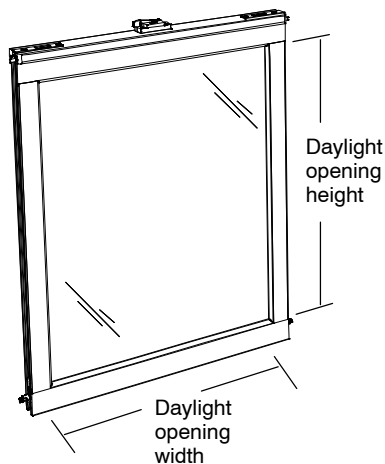
1. Which sash is being replaced – top and bottom
2. Equal Sash, Cottage, or Reverse Cottage Units
3. Size – provide the corresponding call number, rough opening, frame size, or outside measurement
4. Glazing
5. Color – Hardware option and original order number if available
Whether or not the original sash was made before or after 3/26/07.
6. If unit has an opening control device, state this on the order.

Screen ordering information provide:

1. Size – provide the corresponding call number, rough opening, frame size, or outside measurement
2. Color
3. Half or full screen
4. Equal Sash, Cottage, or Reverse Cottage units and original order number if available

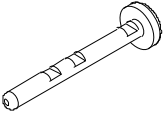
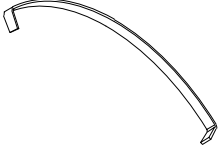
NOTES: Use the sash, frame and DLO charts to help determine sash and screen sizes.
Original order number can be found etched into corner of glass or on label adhered to side of sash frame.

NOTES: OM of screen includes corner keys.



Half Screen shown

INTEGRITY ALL ULTREX SINGLE HUNG
SASH AND SCREEN REPLACEMENT

ILLUSTRATION <i>NOT TO SCALE</i>	DESCRIPTION	OPER./ COLOR	PART NO.
	Friction Plunger, Screen New Usage dates: 1/28/2019 – Present	Clear	10508195
	Screen Leaf Spring M060 Usage dates: 1/28/2019 – Present		11900897

Use this chart to determine sizes for replacement parts, sash and screen.

- Daylight Opening (DLO) is a measurement of the visible glass.
- Outside measurement = OM
- Sizes for Single / Double Hung manufactured 4/24/2006 – present.

OPERATOR SASH - EQUAL SASH UNITS					
WIDTH					
Unit CN	Frame OM	Sash OM	1/2 Screen OM	Full Screen OM	DLO
16	17 1/2" (445)	15 1/4" (387)	15 23/32" (401)	15 23/32" (401)	12 9/16" (319)
20	23 1/2" (597)	21 1/4" (540)	21 23/32" (553)	21 23/32" (553)	18 9/16" (471)
26	29 1/2" (749)	27 1/4" (692)	27 23/32" (629)	27 23/32" (629)	24 9/16" (624)
28	31 1/2" (800)	29 1/4" (743)	29 23/32" (736)	29 23/32" (736)	26 9/16" (675)
30	35 1/2" (902)	33 1/4" (845)	33 23/32" (706)	33 23/32" (706)	30 9/16" (776)
36	41 1/2"(1054)	39 1/4" (997)	39 23/32"(1010)	39 23/32" (1010)	36 9/16" (929)
40	47 1/2"(1207)	45 1/4"(1149)	45 23/32"(1163)	45 23/32" (1163)	42 9/16"(1081)
HEIGHT					
Unit CN	Frame OM	Sash OM	1/2 Screen OM	Full Screen OM	DLO
20	23 1/2" (597)	11" (279)	11 1/8" (283)	21 15/16" (557)	8 5/16" (211)
26	29 1/2" (749)	14" (356)	14 1/8" (359)	27 15/16" (710)	11 5/16" (287)
30	35 1/2" (851)	17" (432)	17 1/8" (435)	33 15/16" (862)	14 5/16" (364)
36	41 1/2"(1054)	20" (508)	20 1/8" (511)	39 15/16" (1014)	17 5/16" (440)
40	47 1/2"(1207)	23" (584)	23 1/8" (587)	45 15/16" (1167)	20 5/16" (516)
46	53 1/2"(1359)	26" (660)	26 1/8" (664)	51 15/16" (1319)	23 5/16" (592)
50	59 1/2"(1511)	29" (737)	29 1/8" (740)	57 15/16" (1472)	26 5/16" (668)
56	65 1/2"(1664)	32" (813)	32 1/8" (816)	63 15/16" (1624)	29 5/16" (745)
60	71 1/2"(1816)	35" (889)	35 1/8" (892)	69 15/16" (1776)	32 5/16" (821)
66	77 1/2"(1969)	38" (965)	38 1/8" (994)	75 15/16" (1929)	35 5/16" (897)

PICTURE/TRANSOM SASH			
WIDTH			
Unit CN	Frame OM	Sash OM	DLO
16	17 1/2" (445)	15 1/4" (387)	12 9/16" (319)
20	23 1/2" (597)	21 1/4" (540)	18 9/16" (471)
26	29 1/2" (749)	27 1/4" (692)	24 9/16" (624)
28	31 1/2" (800)	29 1/4" (743)	24 9/16" (624)
30	35 1/2" (902)	33 1/4" (845)	30 9/16" (776)
36	41 1/2"(1054)	39 1/4" (997)	36 9/16" (929)
40	47 1/2"(1207)	45 1/4"(1149)	42 9/16"(1081)
50	59 1/2"(1511)	57 1/4"(1454)	54 9/16"(1386)
60	71 1/2"(1816)	69 1/4"(1759)	66 9/16"(1691)
HEIGHT			
Unit CN	Frame OM	Sash OM	DLO
10	11 1/2" (292)	9 1/4" (235)	6 9/16" (167)
16	17 1/2" (445)	15 1/4" (387)	12 9/16" (319)
20	23 1/2" (597)	21 1/4" (540)	18 9/16" (471)
26	29 1/2" (749)	27 1/4" (692)	24 9/16" (624)
30	35 1/2" (902)	33 1/4" (845)	30 9/16" (776)
36	41 1/2"(1054)	39 1/4" (997)	36 9/16" (929)
40	47 1/2"(1207)	45 1/4"(1149)	42 9/16"(1081)
46	53 1/2"(1359)	51 1/4"(1302)	48 9/16"(1233)
50	59 1/2"(1511)	57 1/4"(1454)	54 9/16"(1386)
56	65 1/2"(1664)	63 1/4"(1607)	60 9/16"(1538)
60	71 1/2"(1816)	69 1/4"(1759)	66 9/16"(1691)
66	77 1/2"(1969)	75 1/4"(1911)	72 9/16"(1843)

BALANCE TUBES

When ordering replacement parts specify:

1. Part number;
2. Quantity (*Part numbers listed are for one balance tube only*)
3. Sash ratio; (equal, cottage, or reverse cottage)
4. STC/OITC glass upgrade or not STC/OITC glass upgrade

NOTES: *The chart below was updated February 10, 2012. Please reference this information when ordering all replacement tubes. The Supplier Reference ID may differ from your original tube marking. Standard or special size units can reference the same supplier Ref ID part number. Additional tube sizes may be found on the special size chart found in AU DH chapter.*

BOTTOM SASH		
Unit CN	Supplier Ref ID	Part Number
1620	10A	106010
1626	13A	106013
1630	16A	106016
1636	19A	106019
1640	22A	106022
1646	25A	106025
1650	28A	106028
1656	31A	106031
1660	34A	106034
1666	37A	106037
2020	10A	106010
2026	13A	106013
2030	16B	106116
2036	19A	106019
2040	22A	106022
2046	25A	106025
2050	28A	106028
2056	31A	106031
2060	34A	106034
2066	37A	106037

BOTTOM SASH		
Unit CN	Supplier Ref ID	Part Number
2620	10B	106110
2626	13B	106113
2630	16B	106116
2636	19B	106119
2640	22B	106122
2646	25B	106125
2650	28B	106128
2656	31B	106131
2660	34B	106134
2666	37B	106137
2820	10B	106110
2826	13C	106113
2830	16C	106216
2836	19B	106119
2840	22B	106122
2846	25B	106125
2850	28B	106128
2856	31B	106131
2860	34B	106134
2866	37C	106237

BOTTOM SASH		
Unit CN	Supplier Ref ID	Part Number
3020	10B	106110
3026	13B	106113
3030	16C	106216
3036	19C	106219
3040	22B	106122
3046	25B	106125
3050	28C	106228
3056	31C	106231
3060	34C	106234
3066	37C	106237
3620	10B	106210
3626	13C	106213
3630	16C	106216
3636	19C	106219
3640	22C	106222
3646	25C	106225
3650	28C	106228
3656	31D	106331
3660	34D	106334
3666	37D	106637

BOTTOM SASH		
Unit CN	Supplier Ref ID	Part Number
4020	10C	106210
4026	13C	106213
4030	16D	106316
4036	19D	106319
4040	22D	106322
4046	25E	106425
4050	28D	106328
4056	31E	106431
4060	34E	106434
4066	37F	106537

BALANCE TUBES

When ordering replacement parts specify:

1. Part number;
2. Quantity (*Part numbers listed are for one balance tube only*)
3. Sash ratio; (equal, cottage, or reverse cottage)
4. STC/OITC glass upgrade or not STC/OITC glass upgrade

NOTES: *STC/OITC glass is made of 3.1 & 4.7 glass – all other glass is made of 3.1 glass on both panes*

NOTES: *Please reference this information when ordering all replacement tubes. The Supplier Reference ID may differ from your original tube marking. Standard or special size units can reference the same supplier Ref ID part number. Additional tube sizes may be found on the special size chart found on the appropriate page.*

BOTTOM SASH		
Unit CN	Supplier Ref ID	Part Number
1620	10A	106010
1626	13A	106013
1630	16A	106016
1636	19A	106019
1640	22A	106022
1646	25A	106025
1650	28A	106028
1656	31A	106031
1660	34A	106034
1666	37A	106037
2020	10B	106110
2026	13B	106113
2030	16B	106116
2036	19B	106119
2040	22B	106122
2046	25B	106125
2050	28B	106128
2056	31B	106131
2060	34B	106134
2066	37B	106137

BOTTOM SASH		
Unit CN	Supplier Ref ID	Part Number
2620	10B	106110
2626	13B	106113
2630	16C	106216
2636	19C	106219
2640	22B	106122
2646	25B	106125
2650	28C	106228
2656	31C	106231
2660	34C	106234
2666	37C	106237
2820	10B	106110
2826	13C	106213
2830	16C	106216
2836	19C	106219
2840	22C	106222
2846	25C	106225
2850	28C	106228
2856	31C	106231
2860	34C	106234
2866	37C	106237

BOTTOM SASH		
Unit CN	Supplier Ref ID	Part Number
3020	10B	106110
3026	13C	106213
3030	16C	106216
3036	19C	106219
3040	22C	106222
3046	25C	106225
3050	28D	106328
3056	31D	106331
3060	34D	106334
3066	37D	106337
3620	10C	106210
3626	13C	106213
3630	16D	106316
3636	19D	106319
3640	22D	106322
3646	25E	106425
3650	28E	106428
3656	31E	106431
3660	34F	106534
3666	37G	106637

BOTTOM SASH		
Unit CN	Supplier Ref ID	Part Number
4020	10D	106310
4026	13D	106313
4030	16E	106416
4036	19E	106419
4040	22E	106422
4046	25G	106625
4050	28F	106528
4056	31G	106631
4060	34H	106734
4066	37I	106837

COTTAGE UNITS

Use this chart to determine sizes for replacement parts, sash and screen.

- Daylight Opening (DLO) is a measurement of the visible glass.
- Outside measurement = OM
- Sizes for Double Hung manufactured 3/26/2007 – present.

OPERATOR SASH - COTTAGE UNITS					
WIDTH					
Unit CN	Frame OM	Sash OM	1/2 Screen OM	Full Screen OM	DLO
16	17 1/2" (445)	15 1/4" (387)	15 23/32" (401)	15 23/32" (401)	12 9/16" (319)
20	23 1/2" (597)	21 1/4" (540)	21 23/32" (553)	21 23/32" (553)	18 9/16" (471)
26	29 1/2" (749)	27 1/4" (692)	27 23/32" (629)	27 23/32" (629)	24 9/16" (624)
28	31 1/2" (800)	29 1/4" (743)	29 23/32" (706)	29 23/32" (706)	26 9/16" (675)
30	35 1/2" (902)	33 1/4" (845)	33 23/32" (736)	33 23/32" (736)	30 9/16" (776)
36	41 1/2" (1054)	39 1/4" (997)	39 23/32" (1010)	39 23/32" (1010)	36 9/16" (929)
40	47 1/2" (1207)	45 1/4" (1149)	45 23/32" (1163)	45 23/32" (1163)	42 9/16" (1081)
HEIGHT					
Unit CN	Frame OM	Sash OM	1/2 Screen OM	Full Screen OM	DLO
26 (top)	29 1/2" (749)	11 17/32" (293)	-	27 15/16" (710)	8 13/16" (224)
26 (btm)	29 1/2" (749)	16 15/32" (419)	16 19/32" (422)	27 15/16" (710)	13 25/32" (350)
30 (top)	35 1/2" (851)	13 29/32" (354)	-	33 15/16" (862)	11 7/32" (285)
30 (btm)	35 1/2" (851)	20 3/32" (510)	20 7/32" (513)	33 15/16" (862)	17 13/32" (442)
36 (top)	41 1/2" (1054)	16 5/16" (415)	-	39 15/16" (1014)	13 5/8" (346)
36 (btm)	41 1/2" (1054)	23 11/16" (602)	23 13/16" (605)	39 15/16" (1014)	21" (533)
40 (top)	47 1/2" (1207)	18 23/32" (475)	-	45 15/16" (1167)	16 1/32" (407)
40 (btm)	47 1/2" (1207)	27 9/32" (693)	27 13/32" (696)	45 15/16" (1167)	24 19/32" (625)
46 (top)	53 1/2" (1359)	21 1/8" (536)	-	51 15/16" (1319)	18 7/16" (468)
46 (btm)	53 1/2" (1359)	30 7/8" (785)	31" (788)	51 15/16" (1319)	28 3/16" (716)
50 (top)	59 1/2" (1511)	23 17/32" (597)	-	57 15/16" (1472)	20 13/16" (529)
50 (btm)	59 1/2" (1511)	34 15/32" (876)	34 19/32" (879)	57 15/16" (1472)	31 25/32" (808)
56 (top)	65 1/2" (1664)	25 29/32" (658)	-	63 15/16" (1624)	23 7/32" (590)
56 (btm)	65 1/2" (1664)	38 3/32" (967)	38 7/32" (971)	63 15/16" (1624)	35 13/32" (899)
60 (top)	77 1/2" (1816)	28 5/16" (719)	-	69 15/16" (1776)	25 5/8" (651)
60 (btm)	77 1/2" (1816)	40 3/32" (1019)	41 13/16" (1062)	69 15/16" (1776)	39" (990)
66 (top)	77 1/2" (1816)	30 23/32" (780)	-	75 15/16" (1929)	28 1/32" (712)
66 (btm)	77 1/2" (1816)	45 9/32" (1150)	45 13/32" (1153)	75 15/16" (1929)	42 19/32" (1082)

BALANCE TUBES

When ordering replacement parts specify:

1. Part number;
2. Quantity; (*Part numbers listed are for one balance tube only*)
3. Top or bottom sash.
4. Sash ratio; (equal, cottage, or reverse cottage)
5. STC/OITC glass upgrade or not STC/OITC glass upgrade

NOTES: Please reference this information when ordering all replacement tubes. The Supplier Reference ID may differ from your original tube marking. Standard or special size units can reference the same supplier Ref ID part number. Additional tube sizes may be found on the special size chart found on the appropriate page.

BOTTOM SASH (WH) - Cottage			BOTTOM SASH (WH) - Cottage			BOTTOM SASH (WH) - Cottage			BOTTOM SASH (WH) - Cottage		
Unit CN	Supplier Ref ID	Part Number	Unit CN	Supplier Ref ID	Part Number	Unit CN	Supplier Ref ID	Part Number	Unit CN	Supplier Ref ID	Part Number
1626	15A	106015	2626	15B	106115	3026	15C	106215	4026	15C	106215
1630	19A	106019	2630	19B	106119	3030	19C	106219	4030	19D	106319
1636	22A	106022	2636	22B	106122	3036	22B	106122	4036	22D	106322
1640	26A	106026	2640	26B	106126	3040	26C	106226	4040	26E	106426
1646	30A	106030	2646	30B	106130	3046	30C	106230	4046	30E	106430
1650	33A	106033	2650	33B	106133	3050	33C	106233	4050	33E	106433
1656	37A	106031	2656	37B	106137	3056	37C	106237	4056	37F	106537
1660	40AA	105040	2660	40B	106140	3060	40D	106340	4060	40G	106640
1666	44AA	105044	2666	44C	106244	3066	44D	106344	4066	44H	106744
2026	15A	106015	2826	15C	106215	3626	15C	106215			
2030	19A	106019	2830	19B	106119	3630	19C	106219			
2036	22A	106022	2836	22B	106122	3636	22C	106222			
2040	26A	106026	2840	26B	106126	3640	26C	106226			
2046	30A	106030	2846	30B	106130	3646	30D	106330			
2050	33A	106033	2850	33B	106133	3650	33D	106333			
2056	37A	106037	2856	37B	106137	3656	37D	106337			
2060	40A	106040	2860	40C	106240	3660	40E	106440			
2066	44B	106144	2866	44C	106244	3666	44F	106544			

BALANCE TUBES

When ordering replacement parts specify:

1. Part number;
2. Quantity; (*Part numbers listed are for one balance tube only*)
3. Sash ratio; (equal, cottage, or reverse cottage)
4. STC/OITC glass upgrade or not STC/OITC glass upgrade.

NOTES: *STC/OITC glass is made of 3.1 & 4.7 glass – all other glass is made of 3.1 glass on both panes*

NOTES: *Units with the STC/OITC glass upgrade could have white balance tubes for both top and bottom sash depending on the unit size. Please reference this information when ordering all replacement tubes. Standard or special size units can reference the same Supplier Ref ID and part number. Additional tube sizes may be found on the appropriate page.*

BOTTOM SASH (WH) - Cottage			BOTTOM SASH (WH) - Cottage			BOTTOM SASH (WH) - Cottage			BOTTOM SASH (WH) - Cottage		
Unit CN	Supplier Ref ID	Part Number	Unit CN	Supplier Ref ID	Part Number	Unit CN	Supplier Ref ID	Part Number	Unit CN	Supplier Ref ID	Part Number
1626	15A	106015	2626	15C	106215	3026	15C	106215	4026	15E	106415
1630	19A	106019	2630	19C	106219	3030	19C	106219	4030	19E	106419
1636	22A	106022	2636	22B	106122	3036	22C	106222	4036	22E	106422
1640	26A	106026	2640	26C	106226	3040	26D	106326	4040	26F	106526
1646	30A	106030	2646	30C	106230	3046	30D	106330	4046	30F	106530
1650	33A	106033	2650	33C	106233	3050	33D	106333	4050	33H	106733
1656	37A	106037	2656	37C	106237	3056	37D	106337	4056	37I	106837
1660	40A	106040	2660	40C	106240	3060	40F	106540	4060	40K U/L	109040
1666	44A	106044	2666	44D	106344	3066	44G	106644	4066	44L U/L	109144
2026	15B	106115	2826	15C	106215	3626	15D	106315			
2030	19B	106119	2830	19C	106219	3630	19D	106319			
2036	22B	106122	2836	22C	106222	3636	22D	106322			
2040	26B	106126	2840	26C	106226	3640	26E	106426			
2046	30B	106130	2846	30C	106230	3646	30E	106430			
2050	33B	106133	2850	33C	106233	3650	33F	106533			
2056	37B	106137	2856	37C	106237	3656	37G	106637			
2060	40B	106140	2860	40D	106340	3660	40H	106740			
2066	44B	106144	2866	44E	106444	3666	44I	106844			

REVERSE COTTAGE UNITS

Use this chart to determine sizes for replacement parts, sash and screen.

- Daylight Opening (DLO) is a measurement of the visible glass.
- Outside measurement = OM
- Sizes for Double Hung manufactured 3/26/2007 – present.

OPERATOR SASH - REVERSE COTTAGE UNITS					
WIDTH					
Unit CN	Frame OM	Sash OM	1/2 Screen OM	Full Screen OM	DLO
16	17 1/2" (445)	15 1/4" (387)	15 23/32" (401)	15 23/32" (401)	12 9/16" (319)
20	23 1/2" (597)	21 1/4" (540)	21 23/32" (553)	21 23/32" (553)	18 9/16" (471)
26	29 1/2" (749)	27 1/4" (692)	27 23/32" (629)	27 23/32" (629)	24 9/16" (624)
28	31 1/2" (800)	29 1/4" (743)	29 23/32" (706)	29 23/32" (706)	26 9/16" (675)
30	35 1/2" (902)	33 1/4" (845)	33 23/32" (736)	33 23/32" (736)	30 9/16" (776)
36	41 1/2" (1054)	39 1/4" (997)	39 23/32" (1010)	39 23/32" (1010)	36 9/16" (929)
40	47 1/2" (1207)	45 1/4" (1149)	45 23/32" (1163)	45 23/32" (1163)	42 9/16" (1081)
HEIGHT					
Unit CN	Frame OM	Sash OM	1/2 Screen OM	Full Screen OM	DLO
26 (top)	29 1/2" (749)	16 15/32" (419)	-	27 15/16" (710)	13 25/32" (350)
26 (btm)	29 1/2" (749)	11 17/32" (293)	11 21/32" (296)	27 15/16" (710)	8 13/16" (224)
30 (top)	35 1/2" (851)	20 3/32" (510)	-	33 15/16" (862)	17 13/32" (442)
30 (btm)	35 1/2" (851)	13 29/32" (354)	14 1/32" (357)	33 15/16" (862)	11 7/32" (285)
36 (top)	41 1/2" (1054)	23 11/16" (602)	-	39 15/16" (1014)	21" (533)
36 (btm)	41 1/2" (1054)	16 5/16" (415)	16 7/16" (418)	39 15/16" (1014)	13 5/8" (346)
40 (top)	47 1/2" (1207)	27 9/32" (693)	-	45 15/16" (1167)	24 19/32" (625)
40 (btm)	47 1/2" (1207)	18 23/32" (475)	18 27/32" (479)	45 15/16" (1167)	16 1/32" (407)
46 (top)	53 1/2" (1359)	30 7/8" (785)	-	51 15/16" (1319)	28 3/16" (716)
46 (btm)	53 1/2" (1359)	21 1/8" (536)	21 1/4" (540)	51 15/16" (1319)	18 7/16" (468)
50 (top)	59 1/2" (1511)	34 15/32" (876)	-	57 15/16" (1472)	31 25/32" (808)
50 (btm)	59 1/2" (1511)	23 17/32" (597)	23 21/32" (601)	57 15/16" (1472)	20 13/16" (529)
56 (top)	65 1/2" (1664)	38 3/32" (967)	-	63 15/16" (1624)	35 13/32" (899)
56 (btm)	65 1/2" (1664)	25 29/32" (658)	26 1/32" (661)	63 15/16" (1624)	23 7/32" (590)
60 (top)	71 1/2" (1816)	40 3/32" (1019)	-	69 15/16" (1776)	39" (990)
60 (btm)	71 1/2" (1816)	28 5/16" (719)	28 7/16" (722)	69 15/16" (1776)	25 5/8" (651)
66 (top)	71 1/2" (1816)	45 9/32" (1150)	-	75 15/16" (1929)	42 19/32" (1082)
66 (btm)	71 1/2" (1816)	30 23/32" (780)	30 27/32" (783)	75 15/16" (1929)	28 1/32" (712)

BALANCE TUBES

When ordering replacement parts specify:

1. Part number;
2. Quantity; (*Part numbers listed are for one balance tube only*)
3. Sash ratio; (equal, cottage, or reverse cottage)
4. STC/OITC glass upgrade or not STC/OITC glass upgrade.

NOTES: *Units with the STC/OITC glass upgrade could have white balance tubes for both top and bottom sash depending on the unit size. Please reference this information when ordering all replacement tubes. Standard or special size units can reference the same Supplier Ref ID and part number. Additional tube sizes may be found on the Special Size Chart found on the appropriate page.*

BOTTOM SASH (WH) - Cottage			BOTTOM SASH (WH) - Cottage			BOTTOM SASH (WH) - Cottage			BOTTOM SASH (WH) - Cottage		
Unit CN	Supplier Ref ID	Part Number	Unit CN	Supplier Ref ID	Part Number	Unit CN	Supplier Ref ID	Part Number	Unit CN	Supplier Ref ID	Part Number
1626	15A	106015	2626	15A	106015	3026	15B	106115	4026	15C	106215
1630	19A	106019	2630	19A	106019	3030	19B	106119	4030	19C	106219
1636	22A	106022	2636	22A	106022	3036	22B	106122	4036	22B	106122
1640	26A	106026	2640	26A	106026	3040	26B	106126	4040	26C	106226
1646	30A	106030	2646	30A	106030	3046	30B	106130	4046	30C	106230
1650	33A	106033	2650	33A	106033	3050	33B	106133	4050	33C	106233
1656	37A	106037	2656	37A	106037	3056	37B	106137	4056	37C	106237
1660	40AA	105040	2660	40A	106040	3060	40B	106140	4060	40D	106340
1666	44AA	105044	2666	44A	106044	3066	44B	106144	4066	44D	106344
2026	15A	106015	2826	15B	106115	3626	15C	106215			
2030	19A	106019	2830	19A	106019	3630	19B	106119			
2036	22A	106022	2836	22A	106022	3636	22B	106122			
2040	26A	106026	2840	26B	106126	3640	26B	106126			
2046	30A	106030	2846	30A	106030	3646	30B	106130			
2050	33A	106033	2850	33A	106033	3650	33B	106133			
2056	37A	106037	2856	37A	106037	3656	37B	106137			
2060	40AA	105040	2860	40B	106140	3660	40C	106240			
2066	44A	106044	2866	44B	106144	3666	44C	106244			

BALANCE TUBES

When ordering replacement parts specify:

1. Part number;
2. Quantity; (*Part numbers listed are for one balance tube only*)
3. Sash ratio; (equal, cottage, or reverse cottage)
4. STC/OITC glass upgrade or not STC/OITC glass upgrade.

NOTES: STC/OITC glass is made of 3.1 & 4.7 glass – all other glass is made of 3.1 glass on both panes

NOTES: Units with the STC/OITC glass upgrade could have white balance tubes for both top and bottom sash depending on the unit size. Please reference this information when ordering all replacement tubes. Standard or special size units can reference the same Supplier Ref ID and part number. Additional tube sizes may be found on the Special Size Chart found on the appropriate page.

BOTTOM SASH (WH) - Cottage			BOTTOM SASH (WH) - Cottage			BOTTOM SASH (WH) - Cottage			BOTTOM SASH (WH) - Cottage		
Unit CN	Supplier Ref ID	Part Number	Unit CN	Supplier Ref ID	Part Number	Unit CN	Supplier Ref ID	Part Number	Unit CN	Supplier Ref ID	Part Number
1626	15A	106015	2626	15B	106115	3026	15C	106215	4026	15C	106215
1630	19A	106019	2630	19B	106119	3030	19B	106119	4030	19C	106219
1636	22A	106022	2636	22B	106122	3036	22B	106122	4036	22C	106222
1640	26A	106026	2640	26B	106126	3040	26B	106126	4040	26C	106226
1646	30A	106030	2646	30B	106130	3046	30B	106130	4046	30D	106330
1650	33A	106033	2650	33B	106133	3050	33B	106133	4050	33D	106333
1656	37A	106037	2656	37B	106137	3056	37B	106137	4056	37D	106337
1660	40AA	105040	2660	40B	106140	3060	40C	106240	4060	40E	106440
1666	44AA	105044	2666	44B	106144	3066	44C	106244	4066	44F	106544
2026	15A	106015	2826	15B	106115	3626	15C	106215			
2030	19A	106019	2830	19B	106119	3630	19C	106219			
2036	22A	106022	2836	22B	106122	3636	22C	106222			
2040	26A	106026	2840	26B	106126	3640	26C	106226			
2046	30A	106030	2846	30B	106130	3646	30C	106230			
2050	33A	106033	2850	33B	106133	3650	33C	106233			
2056	37A	106037	2856	37B	106137	3656	37C	106237			
2060	40A	106040	2860	40B	106140	3660	40D	106340			
2066	44A	106044	2866	44B	106144	3666	44D	106344			

BALANCE TUBES

When ordering replacement parts specify:

1. Part number;
2. Quantity; (*Part numbers listed are for one balance tube only*)
3. Sash ratio; (equal, cottage, or reverse cottage)
4. STC/OITC glass upgrade or not STC/OITC glass upgrade.

NOTES: *Units with the STC/OITC glass upgrade could have white balance tubes for both top and bottom sash depending on the unit size. Please reference this information when ordering all replacement tubes. Standard or special size units can reference the same Supplier Ref ID and part number.*

WHITE		WHITE		WHITE		WHITE		WHITE	
Supplier Ref ID	Part Number	Supplier Ref ID	Part Number	Supplier Ref ID	Part Number	Supplier Ref ID	Part Number	Supplier Ref ID	Part Number
10A	106010	15A	106015	19A	106019	22A	106022	25A	106025
10B	106110	15B	106115	19B	106119	22B	106122	25B	106125
10C	106210	15C	106215	19C	106219	22C	106222	25C	106225
10D	106310	15D	106315	19D	106319	22D	106322	25D	106325
10E	106410	15E	106415	19E	106419	22E	106422	25E	106425
11A	106011	15F	106515	19F	106519	22F	106522	25F	106525
11B	106111	15G	106615	19G	106619	22G	106622	25G	106625
11C	106211	16A	106016	19H U/L*	106719	23A	106023	25H	106725
11D	106311	16B	106116	20A	106020	23B	106123	25I U/L*	106825
11E U/L*	106411	16C	106216	20B	106120	23C	106223	26A	106026
12A	106012	16D	106316	20C	106220	23D	106323	26B	106126
12B	106112	16E	106416	20D	106320	23E	106423	26C	106226
12C	106212	16F	106516	20E	106420	23F	106523	26D	106326
12D	106312	16G	106616	20F	106520	23G	106623	26E	106426
12E U/L*	106412	17A	106017	20G	106620	23H	106723	26F	106526
13A	106013	17B	106117	21A	106021	24A	106024	26G	106626
13B	106113	17C	106217	21B	106121	24B	106124	26H	106726
13C	106213	17D	106317	21C	106221	24C	106224	27A	106027
13D	106313	17E	106417	21D	106321	24D	106324	27B	106127
13E	106413	17F	106517	21E	106421	24E	106424	27C	106227
13F U/L*	106513	17G	106617	21F	106521	24F	106524	27D	106327
14A	106014	18A	106018	21G	106621	24G	106624	27E	106427
14B	106114	18B	106118			24H	106724	27F	106527
14C	106214	18C	106218					27G	106627
14D	106314	18D	106318					27H	106727
14E	106414	18E	106418						
14F	106514	18F	106518						
		18G U/L*	106618						

* U/L designates a limited travel balance tube

BALANCE TUBES

When ordering replacement parts specify:

1. Part number;
2. Quantity; (*Part numbers listed are for one balance tube only*)
3. Sash ratio; (equal, cottage, or reverse cottage)
4. STC/OITC glass upgrade or not STC/OITC glass upgrade.

NOTES: Units with the STC/OITC glass upgrade could have white balance tubes for both top and bottom sash depending on the unit size. Please reference this information when ordering all replacement tubes. Standard or special size units can reference the same Supplier Ref ID and part number.

WHITE		WHITE		WHITE		WHITE		WHITE	
Supplier Ref ID	Part Number	Supplier Ref ID	Part Number	Supplier Ref ID	Part Number	Supplier Ref ID	Part Number	Supplier Ref ID	Part Number
28A	106028	30A	106030	32A	106032	34A	106034	36A	106036
28B	106128	30B	106130	32B	106132	34B	106134	36B	106136
28C	106228	30C	106230	32C	106232	34C	106234	36C	106236
28D	106328	30D	106330	32D	106332	34D	106334	36D	106336
28E	106428	30E	106430	32E	106432	34E	106434	36E	106436
28F	106528	30F	106530	32F	106532	34F	106534	36F	106536
28G	106628	30G	106630	32G	106632	34G	106634	36G	106636
28H	106728	30H	106730	32H	106732	34H	106734	36H	106736
29A	106029	30I U/L*	106830	32I U/L*	106832	34I	106834	36I	106836
29B	106129	31A	106031	32J U/L*	106932	34J U/L*	106934	36J U/L*	106936
29C	106229	31B	106131	33A	106033	34K U/L*	109034	36K U/L*	109036
29D	106329	31C	106231	33B	106133	35A	106035	37A	106037
29E	106429	31D	106331	33C	106233	35B	106135	37B	106137
29F	106529	31E	106431	33D	106333	35C	106235	37C	106237
29G	106629	31F	106531	33E	106433	35D	106335	37D	106337
29H	106729	31G	106631	33F	106533	35E	106435	37E	106437
		31H	106731	33G	106633	35F	106535	37F	106537
		31I U/L*	106831	33H	106733	35G	106635	37G	106637
		31J U/L*	106931	33I	109833	35H	106735	37H	106737
				33J U/L*	109933	35I	106835	37I	106837
						35J U/L*	109935	37J U/L*	106937
						35K U/L*	108035	37K U/L*	109037
								37L U/L*	109137

* U/L designates a limited travel balance tube

BALANCE TUBES

When ordering replacement parts specify:

1. Part number;
2. Quantity; (*Part numbers listed are for one balance tube only*)
3. Sash ratio; (equal, cottage, or reverse cottage)
4. STC/OITC glass upgrade or not STC/OITC glass upgrade.

NOTES: Units with the STC/OITC glass upgrade could have white balance tubes for both top and bottom sash depending on the unit size. Please reference this information when ordering all replacement tubes. Standard or special size units can reference the same Supplier Ref ID and part number.

WHITE		WHITE		WHITE		WHITE	
Supplier Ref ID	Part Number	Supplier Ref ID	Part Number	Supplier Ref ID	Part Number	Supplier Ref ID	Part Number
38AA	105038	40AA	105040	41AA	105041	43AA	105043
38A	106038	40A	106040	41A	106041	43A	106043
38B	106138	40B	106140	41B	106141	43B	106143
38C	106238	40C	106240	41C	106241	43C	106243
38D	106338	40D	106340	41D	106341	43D	106343
38E	106438	40E	106440	41E	106441	43E	106443
38F	106538	40F	106540	41F	106541	43F	106543
38G	106638	40G	106640	41G	106641	43G	106643
38H	106738	40H	106740	41H	106741	43H	106743
38I	106838	40I	116840	41I	106841	43I	106843
38J U/L*	106938	40J U/L*	106940	41J U/L*	106941	43J U/L*	106943
38K U/L*	109038	40K U/L*	109040	41K U/L*	109041	43K U/L*	109043
38L U/L*	109138	40L U/L*	109140	41L U/L*	109141	43L U/L*	109143
39AA	105039	40M U/L*	119240	41ML	109241	43ML	109236
39A	106039			36MU-41	109236	36MU-43	108336
39B	106139			42AA	105042	43NL	109443
39C	106239			42A	106042	36NU-43	109436
39D	106339			42B	106142	44AA	105044
39E	106439			42C	106242	44A	106044
39F	106539			42D	106342	44B	106144
39G	106639			42E	106442	44C	106244
39H	106739			42F	106542	44D	106344
39I	106839			42G	106642	44E	106444
39J U/L*	106939			42H	106742	44F	106544
39K U/L*	109039			42I	106842	44G	106644
39L U/L*	109139			42J U/L*	106942	44H	106744
39M U/L*	109239			42K U/L*	107242	44I	106844
				42L U/L*	109142	44J U/L*	106945
				42M U/L*	109242	44K U/L*	117144
				42NL	109342	44L U/L*	109144
				36NU-42	109336		

* U/L designates a limited travel balance tube

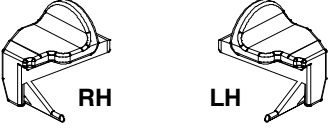
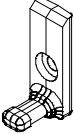
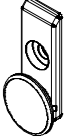
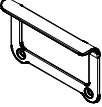
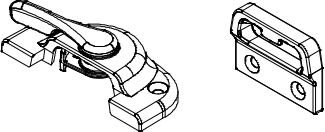
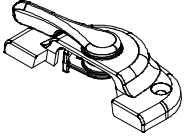
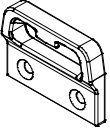
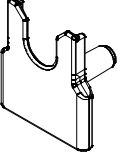
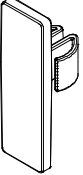
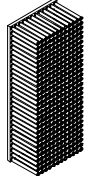
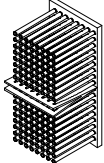
ILLUSTRATION NOT TO SCALE	DESCRIPTION	OPER./COLOR	PART NO.
	<p>Bottom Sash Tilt Latch <i>NOTE: Used prior to 9/2006</i></p>	<p>Stone White LH RH</p>	<p>11869723 11869722</p>
	<p>Bottom Sash Tilt Pin <i>Uses 1 recommended fastener: #7 x 3/4" Phillips pan head screw (118036)</i></p>		<p>10815279</p>
	<p>Top Sash Tilt Pin <i>Usage: 4/2006 – 3/2009</i> <i>includes:</i> 1 – Tilt pin 1 – #8 x 1/2" Phillips pan head screw</p>	<p>Black</p>	<p>10500039</p>
	<p>Sash Lift</p>	<p>Discontinued Replace with Current</p>	
	<p>Sash Cam Lock and Keeper <i>Usage: 11/2006 – 8/29/2013.</i> <i>includes:</i> 1 – Cam lock 1 – Keeper 4 – #6 x 7/8" Phillips flat head screws</p>	<p>Stone White Almond Frost Brass Satin Nickel Oil Rubbed Bronze</p>	<p>11850117 11850144 11850146 11850148 11850151</p>
	<p>Sash Cam Lock <i>Usage: 11/2006 – 8/26/2013.</i> <i>includes:</i> 1 – Cam lock 2 – #6 x 7/8" Phillips flat head screws</p>	<p>Stone White Almond Frost Brass Satin Nickel Oil Rubbed Bronze</p>	<p>10814031 10814033 10814035 10814037 10814039</p>
	<p>Sash Keeper <i>Usage: 11/2006 – 8/26/2013.</i> <i>includes:</i> 1 – Keeper 2 – #6 x 7/8" Phillips flat head screws</p>	<p>Stone White Almond Frost Brass Satin Nickel Oil Rubbed Bronze</p>	<p>10817050 10817065 10817066 10817067 10817068</p>
	<p>Stationary Sash Hanger <i>Usage: 4/2006 – 3/2009</i> <i>includes:</i> 1 – Hanger 1 – #8 x 1/2" Phillips pan head screw</p>	<p>Black</p>	<p>10500038</p>
	<p>Bottom Sash Stop <i>Usage: 4/2006 – 8/26/2013</i></p>	<p>White</p>	<p>11860800</p>

ILLUSTRATION <i>NOT TO SCALE</i>	DESCRIPTION	OPER./COLOR	PART NO.
	<p>Check Rail Dust Block 1 3/16" x 7/16" x 1/4" – adhesive backed</p>		<p>Discontinued replace with 1050049</p>
	<p>Check Rail Dust Block <i>Usage: 4/2006 – 3/2009</i> 1 1/4" x 3/8" <i>NOTE: Adhesive backed</i></p>	<p>Gray</p>	<p>10500239</p>

When ordering replacement Integrity Single Hung weather strip and vinyl parts specify:

1. Description;
2. Profile number;
3. Part number;
4. Quantity,
5. Standard or custom size;
6. Equal sash, Cottage, or Reverse Cottage unit;
7. Length of part.

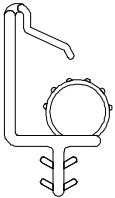
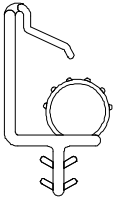

ILLUSTRATION <i>NOT TO SCALE</i>	DESCRIPTION	LENGTH/COLOR	PART NO.
	<p>Frame Weather Strip – Jamb V1541 <i>Usage: 11/2007 – 1/9/2017.</i> Equal Sash</p>	<p>Beige</p> <p>CN20 10 13/32" (264) CN26 13 13/32" (340) CN30 16 13/32" (417) CN36 19 13/32" (493) CN40 22 13/32" (569) CN46 25 13/32" (645) CN50 28 13/32" (721) CN56 31 13/32" (797) CN60 34 13/32" (873) CN66 37 13/32" (950) Lineal 96" (2438)</p>	<p>Discontinued Replace w/V1143</p>
 <p><i>Usage: GY (Obsolete) used 4/2006–11/2007</i></p>	<p>Frame Weather Strip – Jamb V1541 <i>Usage: 4/2006–11/2007</i></p>	<p>Gray</p> <p>CN20 10 17/32" (267) CN26 13 17/32" (344) CN30 16 17/32" (420) CN36 19 17/32" (496) CN40 22 17/32" (572) CN46 25 17/32" (648) CN50 28 17/32" (725) CN56 31 17/32" (801) CN60 34 17/32" (877) CN66/CN56C 37 17/32" (953) Lineal 144" (3658)</p>	<p>17000224 17000230 17000236 17000242 17000248 17000254 17000260 17000266 17000272 17000278 17000299</p>
	<p>Sill Weather Strip V1992 <i>Usage: 2/22/2010 – 8/29/2011</i></p>	<p>Discontinued replace with V2099</p>	

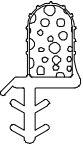
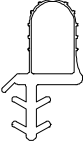

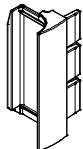
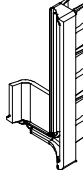
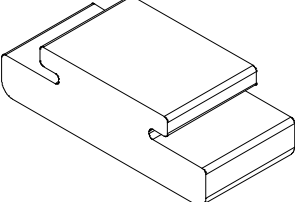
ILLUSTRATION NOT TO SCALE	DESCRIPTION	LENGTH/COLOR	PART NO.
	<p>Frame Weather Strip – Sill V1452 <i>Usage: 11/2007 – 2/22/2010</i></p>	<p>Beige</p> <p>CN16 15 1/4" (387) CN20 21 1/4" (540) CN26 27 1/4" (692) CN28 29 1/4" (743) CN30 33 1/4" (845) CN36 39 1/4" (997) CN40 45 1/4" (1149) Lineal 96" (2438)</p>	<p>17333318 17333324 17333330 17333333 17333336 17333342 17333348 17333396</p>
 <p><i>Usage: GY (Obsolete) used 4/2006–11/2007</i></p>	<p>Frame Weather Strip – Sill V1452 <i>Usage: 4/2006 – 11/2007</i></p>	<p>Gray</p> <p>CN16 15 1/4" (387) CN20 21 1/4" (540) CN26 27 1/4" (692) CN30 33 1/4" (845) CN36 39 1/4" (997) CN40 45 1/4" (1149) Lineal 96" (2438)</p>	<p>17000318 17000324 17000330 17000336 17000342 17000348 17000396</p>
	<p>Sill Liner End Cap <i>NOTE: Use for replacement of sill liner seals on all units produced prior to 2/27/17.</i></p>	<p>Stone White LH RH</p>	<p>11862644 11862643</p>
 <p><i>NOTE: RH Shown</i></p>	<p>Sill Liner Seal <i>Usage: 9/24/07 – 2/27/2017.</i></p>	<p>Discontinued – Replace with Sill Liner End Cap</p>	
 <p><i>NOTE: RH Shown</i></p>	<p>Sill Liner Seal <i>Usage: 4/2006 – 9/2007</i></p>	<p>Discontinued – Replace with current version.</p>	
	<p>Sash Seal <i>Usage: 4/2006 – 3/2009</i> 3/4" x 3/4" x 1 5/32"</p>	<p>White</p>	<p>10501105</p>

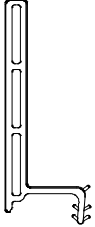

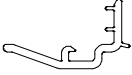

ILLUSTRATION NOT TO SCALE	DESCRIPTION	LENGTH/COLOR	PART NO.																														
	<p>Sill Liner V1552 Usage: 9/24/2007 – 2/27/2017. NOTE: For units produced before 02/27/17 replace sill liner seal as well with sill liner end cap.</p>	<p>Stone White</p> <table border="0"> <tr><td>CN16</td><td>15 15/64" (387)</td></tr> <tr><td>CN20</td><td>21 15/64" (539)</td></tr> <tr><td>CN26</td><td>27 15/64" (692)</td></tr> <tr><td>CN28</td><td>29 15/64" (743)</td></tr> <tr><td>CN30</td><td>33 15/64" (844)</td></tr> <tr><td>CN36</td><td>39 15/64" (997)</td></tr> <tr><td>CN40</td><td>45 15/64" (1149)</td></tr> <tr><td>CN50</td><td>57 15/64" (1454)</td></tr> <tr><td>CN60</td><td>69 15/64" (1759)</td></tr> <tr><td>Lineal</td><td>96" (2438)</td></tr> </table>	CN16	15 15/64" (387)	CN20	21 15/64" (539)	CN26	27 15/64" (692)	CN28	29 15/64" (743)	CN30	33 15/64" (844)	CN36	39 15/64" (997)	CN40	45 15/64" (1149)	CN50	57 15/64" (1454)	CN60	69 15/64" (1759)	Lineal	96" (2438)	<table border="0"> <tr><td>31511216</td></tr> <tr><td>31511220</td></tr> <tr><td>31511226</td></tr> <tr><td>31511228</td></tr> <tr><td>31511230</td></tr> <tr><td>31511236</td></tr> <tr><td>31511240</td></tr> <tr><td>31511250</td></tr> <tr><td>31511260</td></tr> <tr><td>31511296</td></tr> </table>	31511216	31511220	31511226	31511228	31511230	31511236	31511240	31511250	31511260	31511296
CN16	15 15/64" (387)																																
CN20	21 15/64" (539)																																
CN26	27 15/64" (692)																																
CN28	29 15/64" (743)																																
CN30	33 15/64" (844)																																
CN36	39 15/64" (997)																																
CN40	45 15/64" (1149)																																
CN50	57 15/64" (1454)																																
CN60	69 15/64" (1759)																																
Lineal	96" (2438)																																
31511216																																	
31511220																																	
31511226																																	
31511228																																	
31511230																																	
31511236																																	
31511240																																	
31511250																																	
31511260																																	
31511296																																	
	<p>Sill Liner V1532 Usage: 4/2006 – 9/2007</p>	<p>Discontinued</p>																															
	<p>Sash Cover – Top V1510 Usage: 4/2006 – 7/2008.</p>	<p>Discontinued – Replace with V1749</p>																															
	<p>Sill Filler – Picture/Transom V1557 Usage: 3/2007 – 2/2017</p>	<p>Stone White</p> <table border="0"> <tr><td>CN16</td><td>15 7/16" (392)</td></tr> <tr><td>CN20</td><td>21 7/16" (545)</td></tr> <tr><td>CN26</td><td>27 7/16" (697)</td></tr> <tr><td>CN28</td><td>29 7/16" (748)</td></tr> <tr><td>CN30</td><td>33 7/16" (849)</td></tr> <tr><td>CN36</td><td>39 7/16" (1002)</td></tr> <tr><td>CN40</td><td>45 7/16" (1154)</td></tr> <tr><td>CN50</td><td>57 7/16" (1459)</td></tr> <tr><td>CN60</td><td>69 7/16" (1764)</td></tr> <tr><td>Lineal</td><td>144" (3658)</td></tr> </table>	CN16	15 7/16" (392)	CN20	21 7/16" (545)	CN26	27 7/16" (697)	CN28	29 7/16" (748)	CN30	33 7/16" (849)	CN36	39 7/16" (1002)	CN40	45 7/16" (1154)	CN50	57 7/16" (1459)	CN60	69 7/16" (1764)	Lineal	144" (3658)	<table border="0"> <tr><td>10007216</td></tr> <tr><td>10007220</td></tr> <tr><td>10007226</td></tr> <tr><td>10007228</td></tr> <tr><td>10007230</td></tr> <tr><td>10007236</td></tr> <tr><td>10007240</td></tr> <tr><td>10007250</td></tr> <tr><td>10007260</td></tr> <tr><td>10007299</td></tr> </table>	10007216	10007220	10007226	10007228	10007230	10007236	10007240	10007250	10007260	10007299
CN16	15 7/16" (392)																																
CN20	21 7/16" (545)																																
CN26	27 7/16" (697)																																
CN28	29 7/16" (748)																																
CN30	33 7/16" (849)																																
CN36	39 7/16" (1002)																																
CN40	45 7/16" (1154)																																
CN50	57 7/16" (1459)																																
CN60	69 7/16" (1764)																																
Lineal	144" (3658)																																
10007216																																	
10007220																																	
10007226																																	
10007228																																	
10007230																																	
10007236																																	
10007240																																	
10007250																																	
10007260																																	
10007299																																	

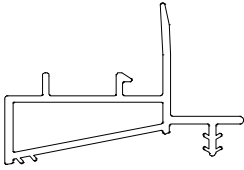
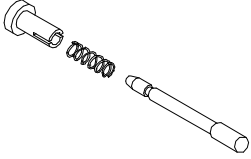
ILLUSTRATION NOT TO SCALE	DESCRIPTION	LENGTH	Stone White PART NO.	Pebble PART NO.	Bronze PART NO.
	Leveling Block V1472 <i>Usage: 4/2006 – 10/2007</i>				
	CN16	15 3/16" (386)	11007216	11007217	11007316
	CN20	21 3/16" (538)	11007220	11007221	11007320
	CN26	27 3/16" (691)	11007226	11007227	11007326
	CN30	33 3/16" (843)	11007230	11007231	11007330
	CN36	39 3/16" (985)	11007236	11007237	11007336
	CN40	45 3/16" (1148)	11007240	11007241	11007340
	CN50	57 3/16" (1453)	11007250	11007251	11007350
	Lineal	96" (2438)	11007296	11007297	11007396

ILLUSTRATION NOT TO SCALE	DESCRIPTION	OPER./ COLOR	PART NO.
	<p>Plunger and Spring Assembly M060 Usage dates: 3/2007 – 1/27/2019 <i>Includes:</i> 1 – Plunger bolt 1 – Plunger bolt cap 1 – Plunger bolt spring</p>	Clear Cap Off White Bolt	11900896