









































































SLIDING PICTURE UNITS

Picture Units

MO (mm)	1'-6" (457)	2'-0" (610)	2'-6" (762)	2'-8" (914)	3'-0" (914)	3'-6" (1067)	4'-0" (1219)	5'-0" (1524)
RO (mm)	1'-6" (457)	2'-0" (610)	2'-6" (762)	2'-8" (914)	3'-0" (914)	3'-6" (1067)	4'-0" (1219)	5'-0" (1524)
FS (mm)	1'-5 1/2" (445)	1'-11 1/2" (597)	2'-5 1/2" (749)	2'-7 1/2" (902)	2'-11 1/2" (902)	3'-5 1/2" (1054)	3'-11 1/2" (1207)	4'-11 1/2" (1511)
DLO (mm)	12 9/16" (319)	18 9/16" (471)	24 9/16" (624)	26 9/16" (675)	30 9/16" (776)	36 9/16" (929)	42 9/16" (1081)	54 9/16" (1381)
1'-11 3/4" (603) 2'-0" (610) 2'-5 1/2" (597) 1'-11 1/2" (471)	 IFSLP1620	 IFSLP2020	 IFSLP2620	 IFSLP2820	 IFSLP3020	 IFSLP3620	 IFSLP4020	 IFSLP5020
2'-5 3/4" (756) 2'-6" (762) 2'-5 1/2" (749) 24 9/16" (624)	 IFSLP1626	 IFSLP2026	 IFSLP2626	 IFSLP2826	 IFSLP3026	 IFSLP3626	 IFSLP4026	 IFSLP5026
2'-11 3/4" (908) 3'-0" (914) 2'-11 1/2" (902) 30 9/16" (776)	 IFSLP1630	 IFSLP2030	 IFSLP2630	 IFSLP2830	 IFSLP3030	 IFSLP3630	 IFSLP4030	 IFSLP5030
3'-5 3/4" (1060) 3'-6" (1067) 3'-5 1/2" (1054) 36 9/16" (929)	 IFSLP1636	 IFSLP2036	 IFSLP2636	 IFSLP2836	 IFSLP3036	 IFSLP3636	 IFSLP4036	 IFSLP5036
3'-11 3/4" (1213) 4'-0" (1219) 3'-11 1/2" (1207) 42 9/16" (1081)	 IFSLP1640	 IFSLP2040	 IFSLP2640	 IFSLP2840	 IFSLP3040	 IFSLP3640	 IFSLP4040	 IFSLP5040
4'-5 3/4" (1365) 4'-6" (1372) 4'-5 1/2" (1359) 48 9/16" (1233)	 IFSLP1646	 IFSLP2046	 IFSLP2646	 IFSLP2846	 IFSLP3046	 IFSLP3646	 IFSLP4046	 IFSLP5046
4'-11 3/4" (1518) 5'-0" (1524) 4'-11 1/2" (1511) 54 9/16" (1386)	 IFSLP1650	 IFSLP2050	 IFSLP2650	 IFSLP2850	 IFSLP3050	 IFSLP3650	 IFSLP4050	 IFSLP5050
5'-5 3/4" (1670) 5'-6" (1676) 5'-5 1/2" (1664) 60 9/16" (1538)	 IFSLP1656	 IFSLP2056	 IFSLP2656	 IFSLP2856	 IFSLP3056	 IFSLP3656	 IFSLP4056	 IFSLP5056
5'-11 3/4" (1822) 6'-0" (1829) 5'-11 1/2" (1816) 66 9/16" (1691)	 IFSLP1660	 IFSLP2060	 IFSLP2660	 IFSLP2860	 IFSLP3060	 IFSLP3660	 IFSLP4060	 IFSLP5060T

SLIDING TRANSMOM UNITS

INTEGRITY® FROM MARVIN®
ALL ULTREX® SERIES

In-Sash Transom

MO (mm)	1' - 6" (457)	2' - 0" (610)	2' - 6" (762)	2' - 8" (914)	3' - 0" (914)	3' - 6" (1067)	4' - 0" (1219)	5' - 0" (1524)
RO (mm)	1' - 6" (457)	2' - 0" (610)	2' - 6" (762)	2' - 8" (914)	3' - 0" (914)	3' - 6" (1067)	4' - 0" (1219)	5' - 0" (1524)
FS (mm)	1' - 5 1/2" (445)	1' - 11 1/2" (597)	2' - 5 1/2" (749)	2' - 7 1/2" (902)	2' - 11 1/2" (902)	3' - 5 1/2" (1054)	3' - 11 1/2" (1207)	4' - 11 1/2" (1511)
DLO (mm)	12 9/16" (319)	18 9/16" (471)	24 9/16" (624)	26 9/16" (675)	30 9/16" (776)	36 9/16" (929)	42 9/16" (1081)	54 9/16" (1381)
MO (mm)	0' - 11 3/4" (298)	1' - 0" (305)	1' - 0" (305)	1' - 0" (305)	1' - 0" (305)	1' - 0" (305)	1' - 0" (305)	1' - 0" (305)
MO (mm)	1' - 5 3/4" (451)	1' - 6" (457)	1' - 6" (457)	1' - 6" (457)	1' - 6" (457)	1' - 6" (457)	1' - 6" (457)	1' - 6" (457)
MO (mm)	1' - 11 1/2" (445)	1' - 5 1/2" (445)	1' - 5 1/2" (445)	1' - 5 1/2" (445)	1' - 5 1/2" (445)	1' - 5 1/2" (445)	1' - 5 1/2" (445)	1' - 5 1/2" (445)
MO (mm)	1' - 11 3/4" (603)	2' - 0" (610)	2' - 0" (610)	2' - 0" (610)	2' - 0" (610)	2' - 0" (610)	2' - 0" (610)	2' - 0" (610)
MO (mm)	1' - 11 1/2" (597)	1' - 11 1/2" (597)	1' - 11 1/2" (597)	1' - 11 1/2" (597)	1' - 11 1/2" (597)	1' - 11 1/2" (597)	1' - 11 1/2" (597)	1' - 11 1/2" (597)
MO (mm)	18 9/16" (471)	18 9/16" (471)	18 9/16" (471)	18 9/16" (471)	18 9/16" (471)	18 9/16" (471)	18 9/16" (471)	18 9/16" (471)
	IFSLT1610	IFSLT2010	IFSLT2610	IFSLT2810	IFSLT3010	IFSLT3610	IFSLT4010	IFSLT5010
	IFSLT1616	IFSLT2016	IFSLT2616	IFSLT2816	IFSLT3016	IFSLT3616	IFSLT4016	IFSLT5016
	IFSLT1620	IFSLT2020	IFSLT2620	IFSLT2820	IFSLT3020	IFSLT3620	IFSLT4020	IFSLT5020

Construction Details

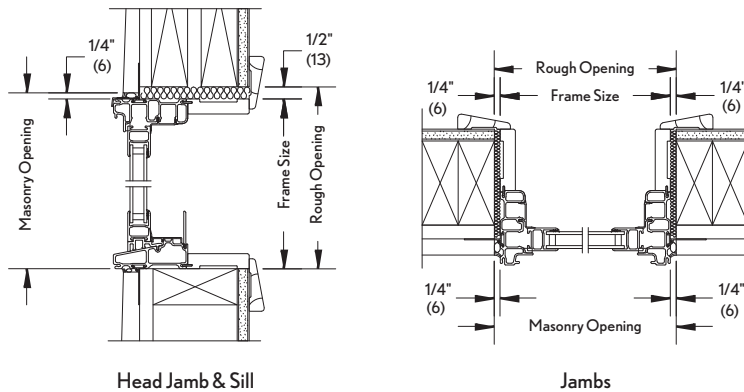

GBG available in standard Rectangular lite cut, shown above. Other GBG lite cuts shown on page 3. (Not available on In-Sash Transom units.)

Details and Elevations not to scale.

Special sized units available within product size matrix. See your Integrity retailer.

See page 52 for specific PG Ratings.

Multiple Assemblies

Multiple assemblies can be factory mullled.

MAXIMUM ROUGH OPENING not to exceed 114" X 78". Maximum up to 6 units wide by 1 unit high.

MAXIMUM ROUGH OPENING not to exceed 96" X 96". Maximum up to 5 units wide by 5 units high.

Field mull kits are available. Structural mullion reinforcement is required for some assemblies.

Please consult your local Integrity from Marvin representative for more information.