

# INTEGRITY WOOD-ULTREX and ALL ULTREX ACCESSORIES

Wood-Ultrex Installation Bracket and Nailing Fin .....	16.2
Wood-Ultrex Interior Accessories .....	16.3
All Ultrex Installation and Nailing Fin .....	16.4
All Ultrex Exterior Accessories .....	16.5
All Ultrex Interior Accessories .....	16.6
Wood-Ultrex and All Ultrex Exterior Casing Elevations .....	16.7
Wood-Ultrex and All Ultrex Exterior Casing Profiles and Parts .....	16.8
Wood-Ultrex Exterior Casing Conversions .....	16.9
All Ultrex Exterior Casing Conversions .....	16.10
Wood-Ultrex and All Ultrex Casing Applications for Windows .....	16.11
Wood-Ultrex and All Ultrex Casing Applications for Doors .....	16.12

## **ATTENTION:**

- Specifications and technical data are subject to change without notice.
- Allow 1/16" (1.59 mm) tolerance on all measurements.
- Interior mullion trim shipped loose for field installation.
- For answers to technical questions about Integrity products you may call our Integrity Support Line: 1-800-587-2712.
- Website: [www.marvin.com](http://www.marvin.com)

Wood-Ultrex Installation Brackets and Nailing Fin

**Installation Brackets**

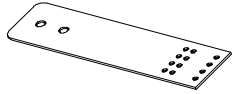

**Integrity Structural Bracket**

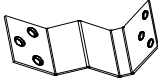

**Installation Clip**

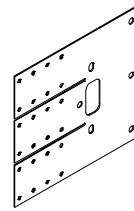

**Masonry Bracket**

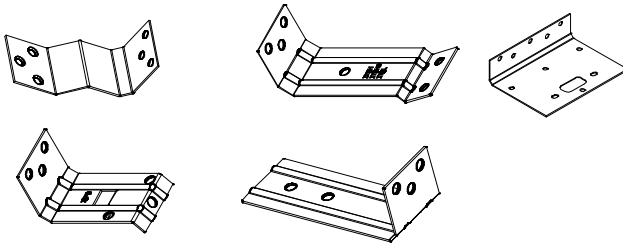

**Nail Fin Installation Kit - Impact**

**Nailing Fin / Drip Cap**

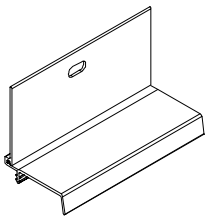

**Head Jamb Nailing Fin/Drip Cap**

V119

Note: Drip cap is clear

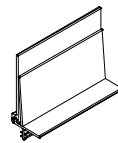

**Radius Head Jamb  
Nailing Fin/Drip Cap**

V110

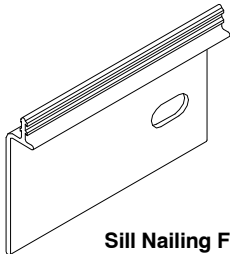

**Sill Nailing Fin**

V084

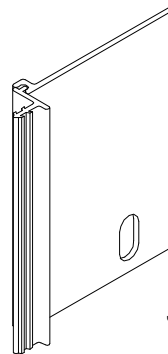

**Jamb Nailing Fin**

V104

Wood-Ultrex Interior Accessories

**Jamb Extension**

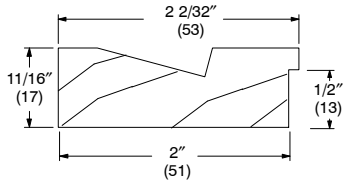

**6 9/16" Jamb Extension**  
W7432

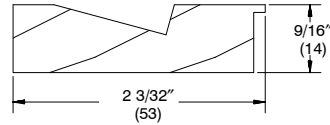

**IIFD to Direct Glaze Jamb**  
**6 9/16" Jamb Extension**  
W7119

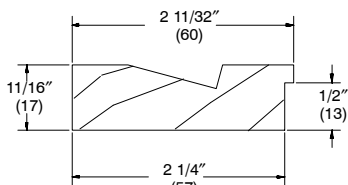

**6 13/16" Jamb Extension**  
W7446

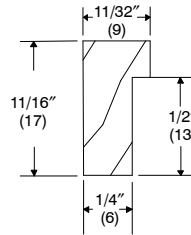

**IIFD 1/4" Jamb Extension for 6 13/16"**  
W2214

**Interior Mullion Trim**

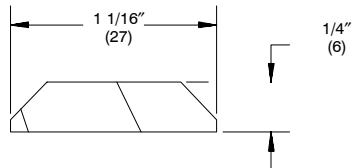

**Interior Mullion Trim**  
W1241

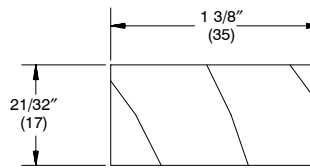

**ICA Mullion Filler Block**  
W6172

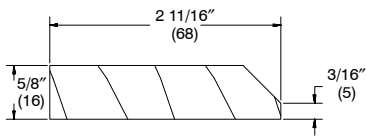

**ICA Wood Mullion Tie**  
W7004

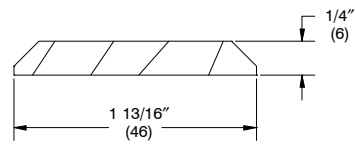

**Horizontal Mull Trim**  
W9159

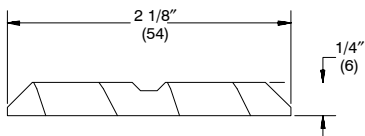

**Interior Mullion Trim**  
W1243

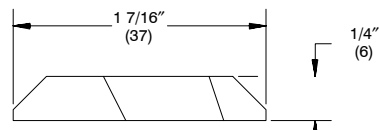

**Interior Mullion Trim**  
W1242

## All Ultrex Installation Brackets and Nailing Fin

---

### Installation Bracket

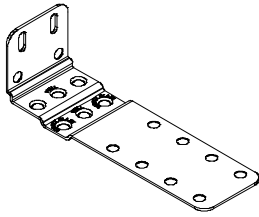

4 9/16" Structural Brackets

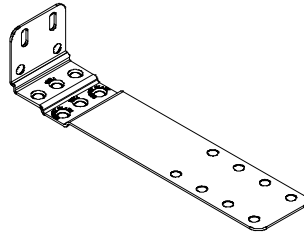

6 9/16" Structural Brackets

### Nailing Fin / Drip Cap



Nailing Fin - Windows and Doors  
V1428

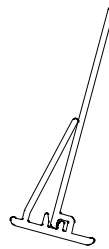

Nailing Fin - Radius  
V2067

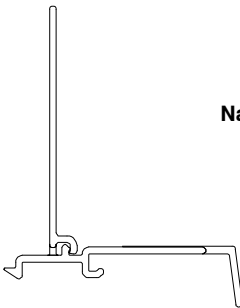

Nailing Fin with Drip Cap -  
Windows and Doors  
V2395

All Ultrex Exterior Accessories

**Frame Expander**

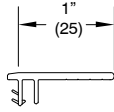

**1" Frame Expander**  
V2034

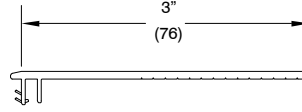

**3" Frame Expander**  
V1780

**Flush Fin**

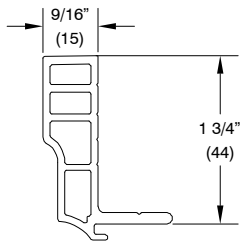

**Flush Fin**  
V2056 - 1 3/4" Flush Fin

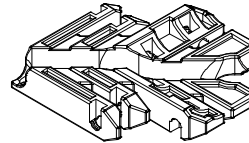

**Flush Fin Corner Key**

**J-Channel**

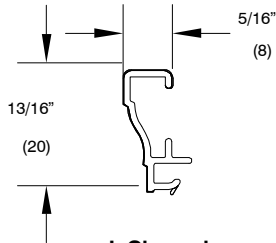

**J-Channel  
Head Jamb and Jamb**  
V1458

Note: Mitered Corners

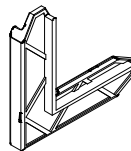

**J-Channel Corner Key**

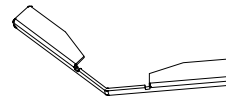

**J-Channel Corner Key,  
Adjustable**

All Ultrex Interior Accessories

**Jamb Extension**

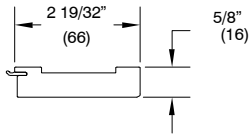

**4 9/16" Jamb Extension – Window**  
V1563

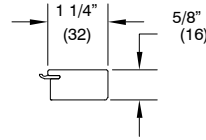

**4 9/16" Door Jamb Extension**  
V1641

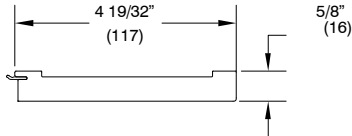

**6 9/16" Jamb Extension – Window**  
V1578

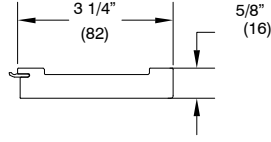

**6 9/16" Door Jamb Extension**  
V1640

**Drywall Return and Receiver**

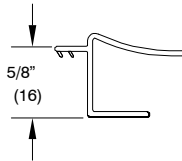

**1/2" to 5/8" Drywall Return**  
V1401

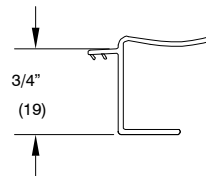

**3/4" Receiver**  
V1710

**Interior Frame Filler**

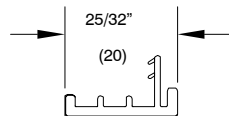

**Interior Frame Filler**  
V2053

Wood-Ultrex and All Ultrex Exterior Casing Elevations

---

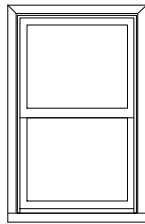

**BMC - Flush  
 With Sill Nosing**

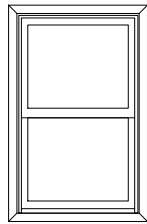

**BMC - Mitered  
 Casing Four Sides**

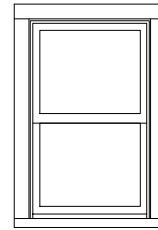

**Flat Casing- Flush  
 With Sill Nosing**

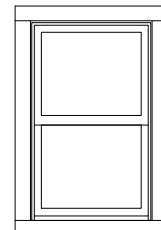

**Flat Casing- Flush  
 Casing Four Sides**

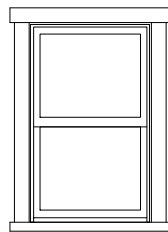

**Flat Casing- Ranch Style  
 With Sill Nosing**

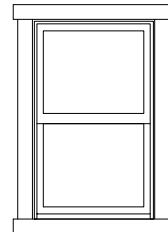

**Flat Casing- Ranch Style  
 Casing Four Sides**

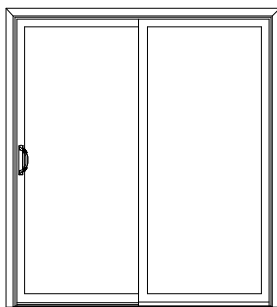

**BMC**

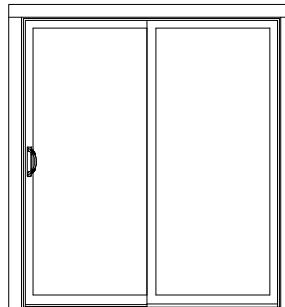

**Flat**

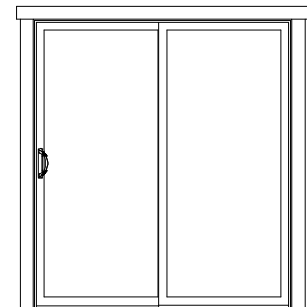

**Ranch Style**

NOTE: Ranch Style casing overhangs each side by 1" (25)

Wood-Ultrex and All Ultrex Exterior Casing Profiles and Parts

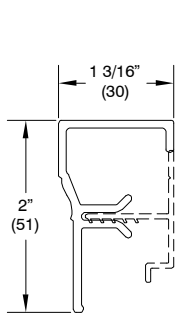

F9105  
BMC - 2"

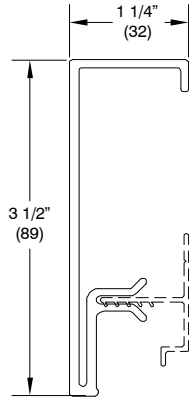

F9108  
Flat Casing - 3.5"

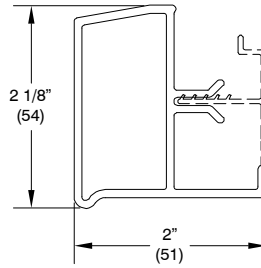

F9107  
Sill Nosing - 2"

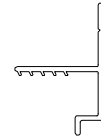

V2177  
Wood-Ultrex  
Connection Barb

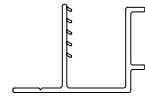

V2691  
All Ultrex  
Connection Barb

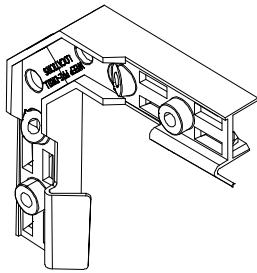

Exterior Casing  
Corner Key

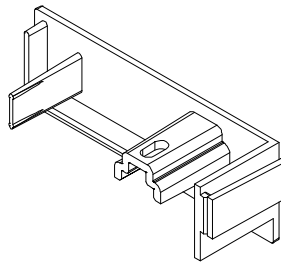

End Cap  
Flat Casing, 3.5"

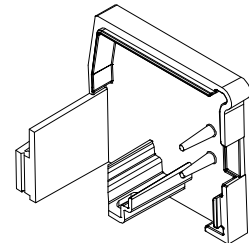

End Cap  
Sill



#7 X .750" Type A-17 PH full thread



Reticulated Foam  
.625" X .625"

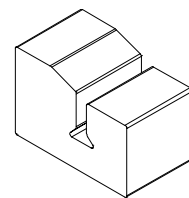

BMC  
Plug



## Wood-Ultrex Exterior Casing Measurement Conversions

Frame Outside Measurement (Wood Ultrex) to Exterior Casing Individual Part Finished Overall Length		
Wood Ultrex Windows		
Exterior Casing Configuration	Part	WU Conversion
BMC (all four sides)	Header & Sill 45 degree end cuts	+ 3 3/8"
	Jambs 45 degree end cuts	+ 3 3/8"
BMC w/ Sill Nosing	Header 45 degree end cuts	+ 3 3/8"
	Sill 90 degree end cuts	+ 2 7/8"
	Jambs 45 degree end cuts on header end 90 degree end cuts on sill end	+ 1 3/8"
3.5" Flat Casing (all four sides)	Header & Sill 90 degree end cuts	+ 6 7/32"
	Jambs 90 degree end cuts	- 5/8"
3.5" Flat Casing w/ Sill Nosing	Header 90 degree end cuts	+ 6 7/32"
	Sill 90 degree end cuts	+ 5 7/8"
	Jambs 90 degree end cuts	- 5/8"
3.5" Flat Casing – Ranch Style	Header & Sill 90 degree end cuts	+ 8 7/32"
	Jambs 90 degree end cuts	- 5/8"
3.5" Flat Casing – Ranch Style w/ Sill Nosing	Header 90 degree end cuts	+ 8 7/32"
	Sill 90 degree end cuts	+ 7 7/8"
	Jambs 90 degree end cuts	- 5/8"
Wood Ultrex Doors		
Exterior Casing Configuration	Part	WU Conversion
BMC	Header 45 degree end cuts	+ 3 3/8"
	Jambs 45 degree end cuts on header end 90 degree end cuts on sill end	+ 1 11/16"
3.5" Flat Casing	Header 90 degree end cuts	+ 6 7/32"
	Jambs 90 degree end cuts	- 3/8"
3.5" Flat Casing – Ranch Style	Header 90 degree end cuts	+ 8 7/32"
	Jambs 90 degree end cuts	- 3/8"
Frame Outside Measurement (Wood Ultrex) to Exterior Casing Outside Measurement Conversion		
Wood Ultrex Windows		
Exterior Casing Configuration	Width	Height
BMC (all four sides)	+ 3 3/8"	+ 3 3/8"
BMC w/ Sill Nosing	+ 3 3/8"	+ 3 3/8"
3.5" Flat Casing (all four sides)	+ 6 3/8"	+ 6 3/8"
3.5" Flat Casing w/ Sill Nosing	+ 6 3/8"	+ 4 7/8"
3.5" Flat Casing – Ranch Style	+ 8 3/8"	+ 6 3/8"
3.5" Flat Casing – Ranch Style w/ Sill Nosing	+ 8 3/8"	+ 4 7/8"
Wood Ultrex Doors		
Exterior Casing Configuration	Width	Height
BMC (header & jambs)	+ 3 3/8"	+ 1 11/16"
3.5" Flat Casing (header & jambs)	+ 6 3/8"	+ 3 3/16"
3.5 Flat Casing – Ranch Style (header & jambs)	+ 8 3/8"	+ 3 3/16"
* Ranch Style header overhangs each jamb & does not have square or rectangle outer shape – see diagrams on page 16.7		

## All Ultrex Exterior Casing Measurement Conversions

Frame Outside Measurement (All-Ultrex) to Exterior Casing Individual Part Finished Overall Length		
All Ultrex Windows		
Exterior Casing Configuration	Part	AU Conversion
BMC (all four sides)	Header & Sill 45 degree end cuts	+ 3 11/16"
	Jambs 45 degree end cuts	+ 3 11/16"
BMC w/ Sill Nosing	Header 45 degree end cuts	+ 3 11/16"
	Sill 90 degree end cuts	+ 3 3/16"
	Jambs 45 degree end cuts on header end 90 degree end cuts on sill end	+ 1 11/16"
3.5" Flat Casing (all four sides)	Header & Sill 90 degree end cuts	+ 6 17/32"
	Jambs 90 degree end cuts	- 5/16"
3.5" Flat Casing w/ Sill Nosing	Header 90 degree end cuts	+ 6 17/32"
	Sill 90 degree end cuts	+ 6 3/16"
	Jambs 90 degree end cuts	- 5/16"
3.5" Flat Casing – Ranch Style	Header & Sill 90 degree end cuts	+ 8 17/32"
	Jambs 90 degree end cuts	- 5/16"
3.5" Flat Casing – Ranch Style w/ Sill Nosing	Header 90 degree end cuts	+ 8 17/32"
	Sill 90 degree end cuts	+ 8 3/16"
	Jambs 90 degree end cuts	- 5/16"
All Ultrex Doors		
Exterior Casing Configuration	Part	AU Conversion
BMC	Header 45 degree end cuts	+ 3 11/16"
	Jambs 45 degree end cuts on header end 90 degree end cuts on sill end	+ 1 27/32"
	Header 90 degree end cuts	+ 6 17/32"
3.5" Flat Casing	Jambs 90 degree end cuts	- 1/4"
	Header 90 degree end cuts	+ 8 17/32"
3.5" Flat Casing – Ranch Style	Jambs 90 degree end cuts	- 1/4"
	Frame Outside Measurement (All-Ultrex) to Exterior Casing Outside Measurement Conversion	
All Ultrex Windows		
Exterior Casing Configuration	Width	Height
BMC (all four sides)	+ 3 11/16"	+ 3 11/16"
BMC w/ Sill Nosing	+ 3 11/16"	+ 3 11/16"
3.5" Flat Casing (all four sides)	+6 11/16"	+6 11/16"
3.5" Flat Casing w/ Sill Nosing	+6 11/16"	+5 3/16"
3.5" Flat Casing – Ranch Style	+8 11/16"*	+6 11/16"
3.5" Flat Casing – Ranch Style w/ Sill Nosing	+8 11/16"*	+5 3/16"
All Ultrex Doors		
Exterior Casing Configuration	Width	Height
BMC (header & jambs)	+3 11/16"	+1 13/16"
3.5" Flat Casing (header & jambs)	+6 11/16"	+3 11/32"
3.5 Flat Casing – Ranch Style (header & jambs)	+8 11/16"*	+3 11/32"
* Ranch Style header overhangs each jamb & does not have square or rectangle outer shape – see diagrams on page 16.7		

Wood-Ultrex and All Ultrex Exterior Exterior Casing Applications for Windows

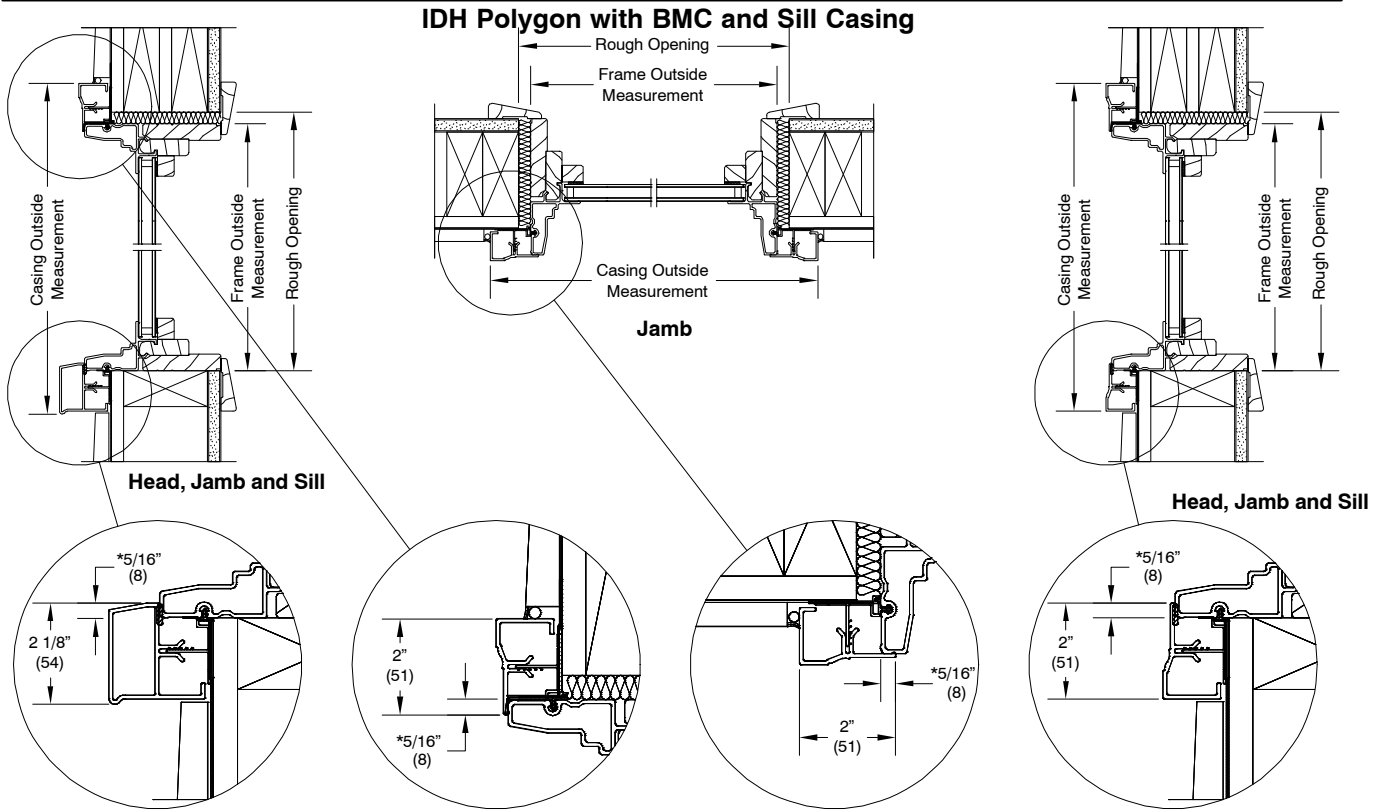

**NOTE: Installation requires a minimum of 1" (25). Projections greater than 1" (25) may require connection bars to be shimmed away from sheeting for compensation.**

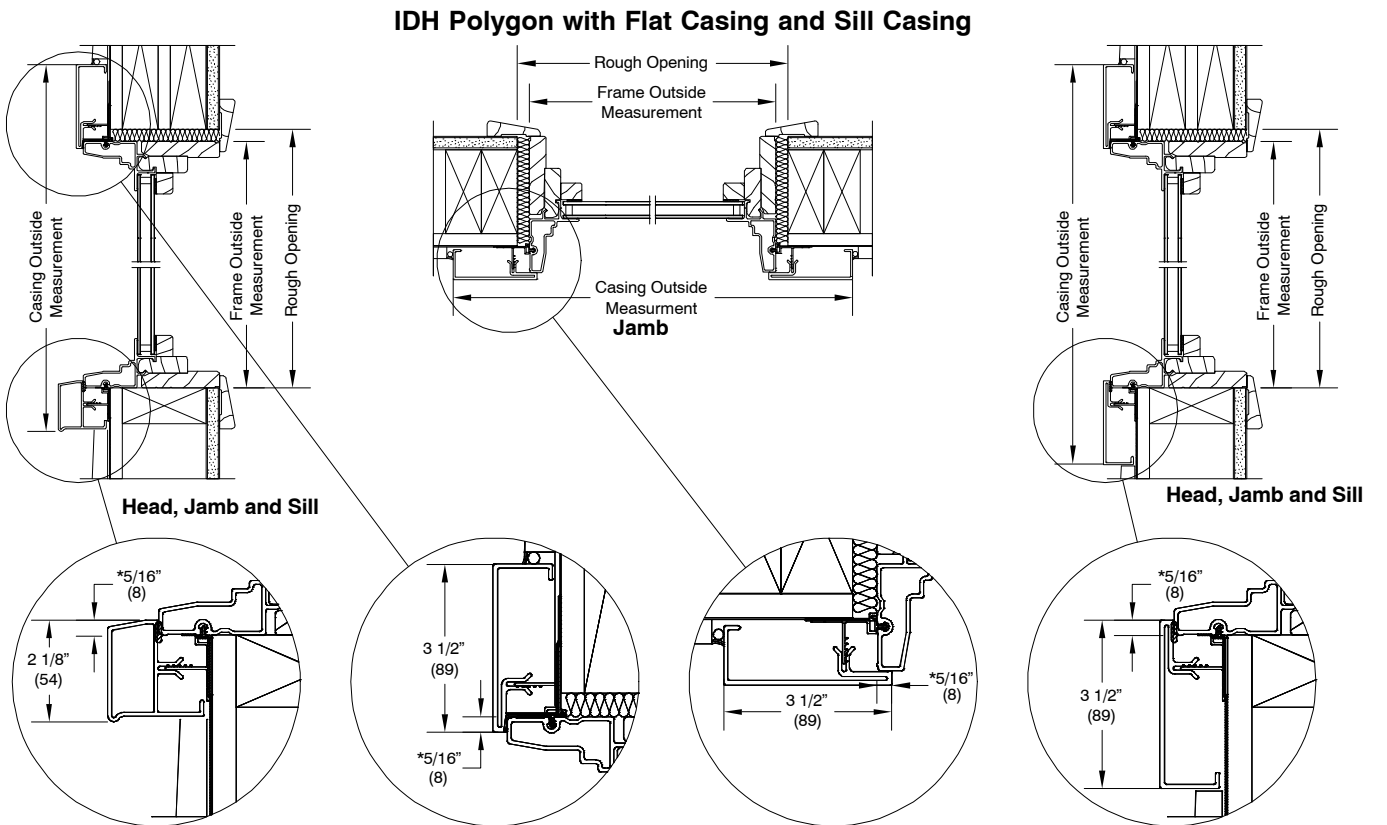

\*NOTE: The 5/16" measurement shown is for Wood-Ultrex. The dimension for All Ultrex is 5/32".

## Wood-Ultrex and All Ultrex Exterior Casing Applications for Doors

### ISFD with BMC

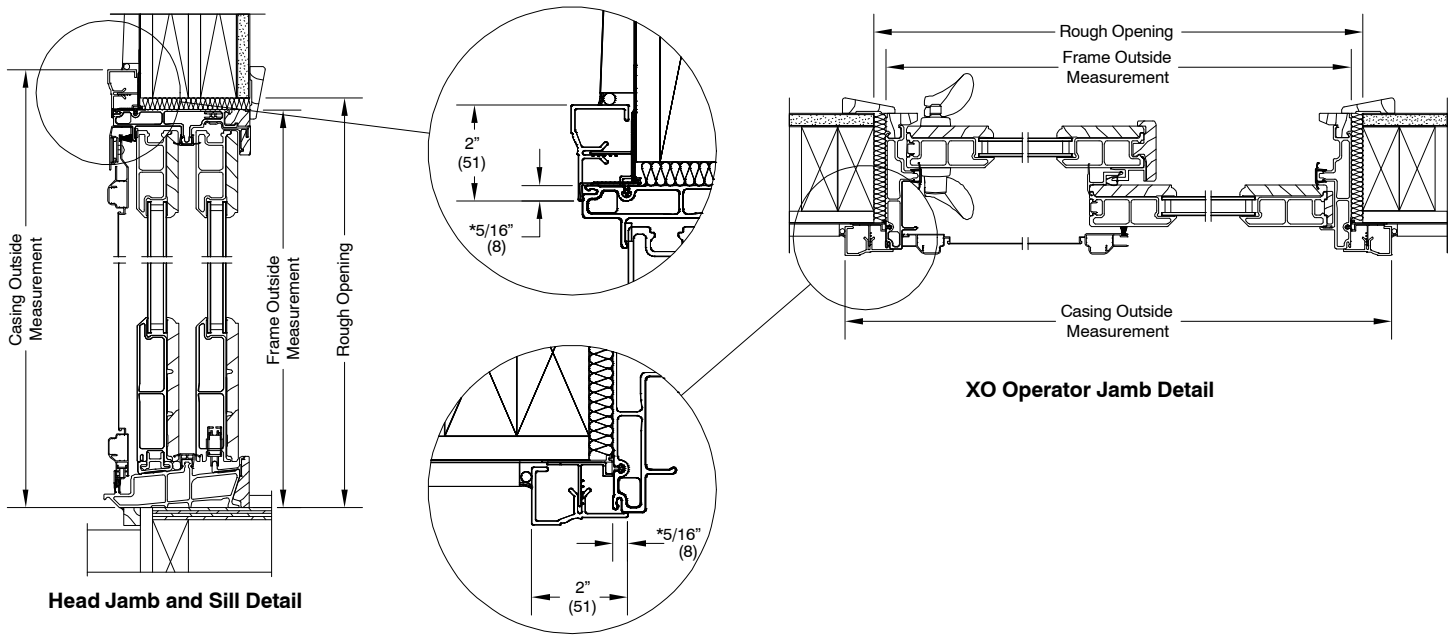

**NOTE: Installation requires a minimum of 1" (25). Projections greater than 1" (25) may require connection bars to be shimmed away from sheeting for compensation.**

### ISFD with Flat Casing

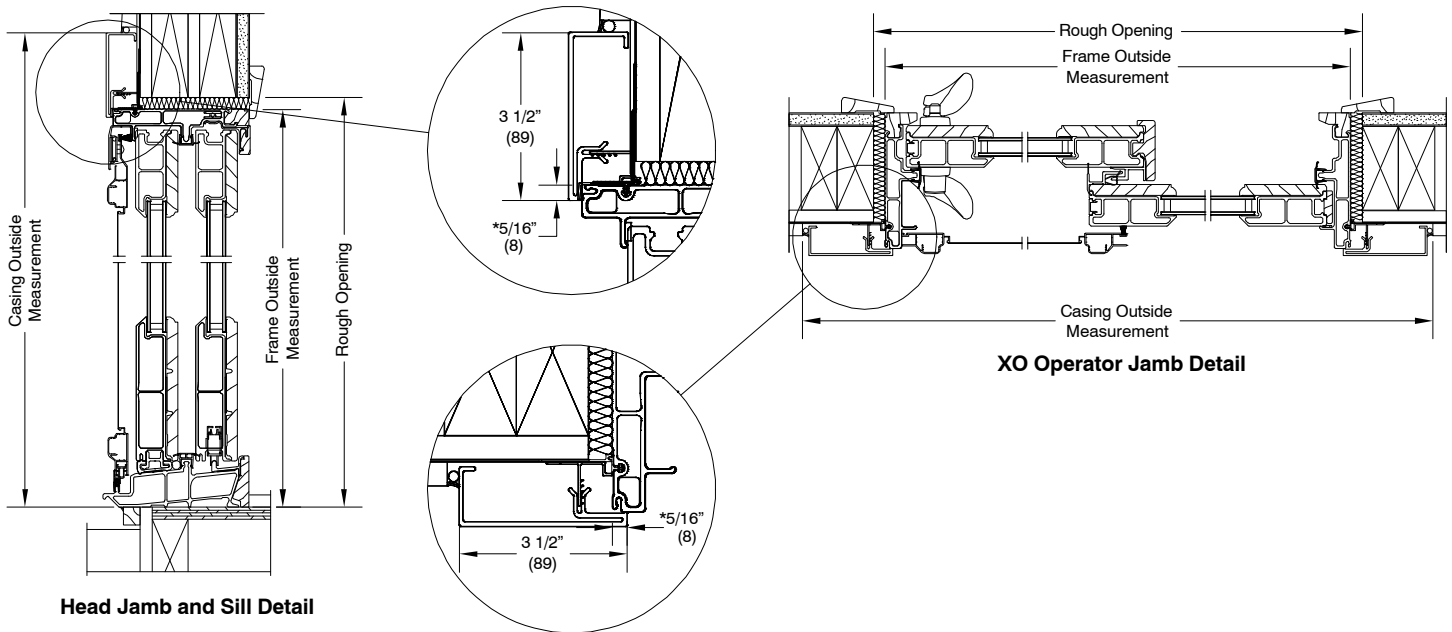

\*NOTE: The 5/16" measurement shown is for Wood-Ultrex. The dimension for All Ultrex is 5/32".