





















CLAD ULTIMATE DOUBLE HUNG TRANSOM UNIT - NEXT GENERATION

MO (mm)	1-9 3/4 (552)	2-13/4 (654)	2-5 3/4 (756)	2-7 3/4 (806)	2-9 3/4 (857)
RO (mm)	1-10 1/4 (565)	2-2 1/4 (667)	2-6 1/4 (768)	2-8 1/4 (819)	2-10 1/4 (870)
FS (mm)	1-9 1/4 (540)	2-1 1/4 (641)	2-5 1/4 (743)	2-7 1/4 (794)	2-9 1/4 (845)
DLO (mm)	14 47/64 (347)	18 47/64 (476)	22 47/64 (577)	24 47/64 (628)	26 47/64 (679)

1-7 15/16 (506) 1-8 3/16 (513) 1-7 11/16 (500) 12 3/4 (324)	 CUDHT-NG1612	 CUDHT-NG2012	 CUDHT-NG2412	 CUDHT-NG2612	 CUDHT-NG2812
2-3 15/16 (710) 2-4 3/16 (716) 2-3 11/16 (703) 20 3/4 (527)	 CUDHT-NG1620	 CUDHT-NG2020	 CUDHT-NG2420	 CUDHT-NG2620	 CUDHT-NG2820
MO (mm)	2-11 3/4 (908)	3-13/4 (959)	3-5 3/4 (1060)	3-9 3/4 (1162)	4-11 3/4 (1518)
RO (mm)	3-0 1/4 (921)	3-2 1/4 (972)	3-6 1/4 (1073)	3-10 1/4 (1175)	5-0 1/4 (1530)
FS (mm)	2-11 1/4 (895)	3-1 1/4 (946)	3-5 1/4 (1048)	3-9 1/4 (1149)	4-11 1/4 (1505)
DLO (mm)	28 47/64 (730)	30 47/64 (781)	34 47/64 (882)	38 47/64 (984)	52 47/64 (1339)
1-7 15/16 (506) 1-8 3/16 (513) 1-7 11/16 (500) 12 3/4 (324)	 CUDHT-NG3012	 CUDHT-NG3212	 CUDHT-NG3612	 CUDHT-NG4012	 CUDHT-NG 5412
2-3 15/16 (710) 2-4 3/16 (716) 2-3 11/16 (703) 20 3/4 (527)	 CUDHT-NG3020	 CUDHT-NG3220	 CUDHT-NG3620	 CUDHT-NG4020	 CUDHT-NG5420

CONSTRUCTION DETAILS

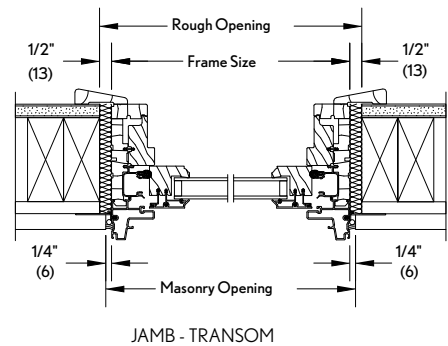
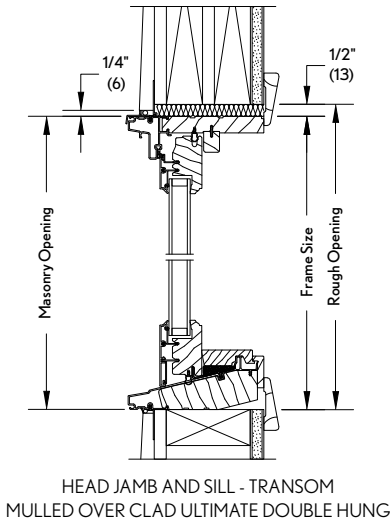

NOTES:

- Please contact your local Marvin® representative for masonry openings that include casings and subsills.

Clad Ultimate Double Hung Transom - Next Generation: **CUDHT-NG**