

































































## CLAD ULTIMATE DOUBLE HUNG PICTURE UNIT - NEXT GENERATION

MO (mm)	3-5 3/4 (1060)	4-1 3/4 (1264)	4-5 3/4 (1365)	5-1 3/4 (1568)	5-9 3/4 (1772)
RO (mm)	3-6 1/4 (1073)	4-2 1/4 (1276)	4-6 1/4 (1378)	5-2 1/4 (1581)	5-10 1/4 (1784)
FS (mm)	3-5 1/4 (1048)	4-1 1/4 (1251)	4-5 1/4 (1353)	5-1 1/4 (1556)	5-9 1/4 (1759)
DLO (mm)	34 47/64 (882)	42 47/64 (1085)	46 47/64 (1187)	54 47/64 (1390)	62 47/64 (1594)
3-3 3/4 (1010) 3-4 (1016) 3-3 1/2 (1003) 3 1/2 (1000)					
CUDHP-NG4038	CUDHP-NG4838	CUDHP-NG5238	CUDHP-NG6038	CUDHP-NG6838	
3-7 3/4 (1111) 3-8 (1118) 3-7 1/2 (1105) 35 27/64 (900)					
CUDHP-NG4042	CUDHP-NG4842	CUDHP-NG5242	CUDHP-NG6042	CUDHP-NG6842	
4-0 5/8 (1235) 4-0 (1219) 3-11/2 (1207) 39 27/64 (1001)					
CUDHP-NG4046	CUDHP-NG4846	CUDHP-NG5246	CUDHP-NG6046	CUDHP-NG6846	
4-4 5/8 (1337) 4-4 (1321) 4-3 1/2 (1308) 43 27/64 (1103)					
CUDHP-NG4050	CUDHP-NG4850	CUDHP-NG5250	CUDHP-NG6050	CUDHP-NG6850	
4-8 5/8 (1438) 4-8 (1422) 4-7 1/2 (1410) 47 27/64 (1204)					
CUDHP-NG4054	CUDHP-NG4854	CUDHP-NG5254	CUDHP-NG6054	CUDHP-NG6854	
5-0 5/8 (1540) 5-0 (1524) 4-11/2 (1511) 51 27/64 (1306)					
CUDHP-NG4058	CUDHP-NG4858	CUDHP-NG5258	CUDHP-NG6058	CUDHP-NG6858	
5-4 5/8 (1641) 5-4 (1626) 5-3 1/2 (1613) 55 27/64 (1408)					
CUDHP-NG4062	CUDHP-NG4862	CUDHP-NG5262	CUDHP-NG6062	CUDHP-NG6862	
5-8 5/8 (1743) 5-8 (1727) 5-7 1/2 (1715) 59 27/64 (1509)					
CUDHP-NG4066	CUDHP-NG4866	CUDHP-NG5266	CUDHP-NG6066	CUDHP-NG6866	
6-0 5/8 (1845) 6-0 (1829) 5-11/2 (1816) 63 27/64 (1611)					
CUDHP-NG4070	CUDHP-NG4870	CUDHP-NG5270	CUDHP-NG6070	CUDHP-NG6870	
6-4 5/8 (1946) 6-4 (1930) 6-3 1/2 (1918) 67 27/64 (1712)					
CUDHP-NG4074	CUDHP-NG4874	CUDHP-NG5274	CUDHP-NG6074	CUDHP-NG6874	

## CLAD ULTIMATE DOUBLE HUNG PICTURE UNIT - NEXT GENERATION

MO (mm)	3-5 3/4 (1060)	4-1 3/4 (1264)	4-5 3/4 (1365)	5-1 3/4 (1568)	5-9 3/4 (1772)
RO (mm)	3-6 1/4 (1073)	4-2 1/4 (1276)	4-6 1/4 (1378)	5-2 1/4 (1581)	5-10 1/4 (1784)
FS (mm)	3-5 1/4 (1048)	4-1 1/4 (1251)	4-5 1/4 (1353)	5-1 1/4 (1556)	5-9 1/4 (1759)
DLO (mm)	34 47/64 (882)	42 47/64 (1085)	46 47/64 (1187)	54 47/64 (1390)	62 47/64 (1594)
6-8 5/8 (2048) 6-8 (2032) 6-7 1/2 (2019) 71 27/64 (1814)					
CUDHP-NG4078	CUDHP-NG4878	CUDHP-NG5278	CUDHP-NG6078	CUDHP-NG6878	
7-4 5/8 (2251) 7-4 (2235) 7-3 1/2 (2223) 79 27/64 (2017)					
CUDHP-NG4086	CUDHP-NG4886	CUDHP-NG5286	CUDHP-NG6086	CUDHP-NG6886	
7-8 5/8 (2353) 7-8 (2337) 7-7 1/2 (2324) 83 27/64 (2119)					
CUDHP-NG4090	CUDHP-NG4890	CUDHP-NG5290	CUDHP-NG6090	CUDHP-NG6890	

### CONSTRUCTION DETAILS

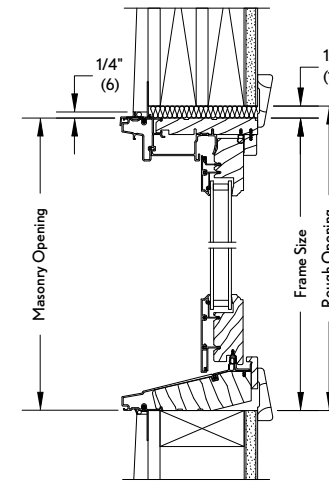

HEAD JAMB AND SILL - PICTURE

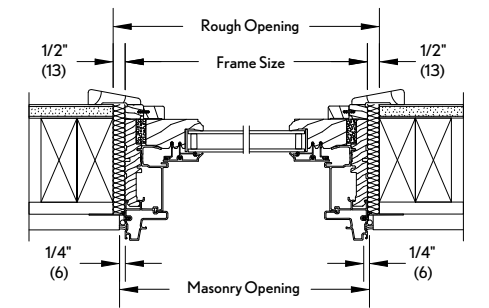

JAMB - PICTURE

### NOTES:

- Please contact your local Marvin® representative for masonry openings that include casings and subsills.

Clad Ultimate Double Hung Picture - Next Generation: **CUDHP-NG**