

Integrity Wood-Ultrex Impact Round Top

Unit Features	1
Conversions and Certified Sizes	2
Available Divided Lite Patterns	3
Section Details: Impact Glazing	4

Wood-Ultrex Impact Round Top

Unit Features

Integrity Wood-Ultrex Impact Round Top: IRT Impact

Frame and Sash:

- The frame exterior is made of Ultrex®, glass reinforced composite material.
- Available colors: Stone White, Pebble Gray, Bronze, Evergreen, Cashmere, or Ebony.
- The interior is non finger-jointed pine, kiln dried to a moisture content of 6-12% at time of fabrication. Water-repellent, preservative treated in accordance with WDMA I.S.4.
- Interior wood is available as pine bare wood or factory applied white, clear, or designer black interior finishes.
- Frame width is 4 9/16" (116).
- 4/4 non finger jointed pine interior stop is applied to all units.

Jamb Extension:

- 6 9/16" (167) and 6 13/16" (173) jamb extension available factory applied or kit form for field application.

Installation:

- Factory applied nailing fin.
- Installation clips provided in addition to nailing fin.
- Optional installation brackets for masonry are available in lieu of folding nailing fin.

Impact Glazing:

- Zone 3 for winds up to 140 miles per hour.
- Glass is laminated insulated Low E2 or E3 Argon, consisting of annealed glass exterior and laminated glass interior.
- The laminated glass is comprised of two pieces of glass with either a SGP or PVB laminate layer between.
 - Interior and exterior glazing tape and exterior is silicone sealant in a sandwich style glazing system.

Wood Removable Interior Grilles:

- Wood grilles are manufactured from non finger-joint pine with a 3/4" (19) x 15/32" (12) bar.
- Available in standard sunburst patterns with an open hub, or standard rectangular lites.
- Pine bare wood or factory applied white, clear, or designer black finishes to match interior.

Interior / Exterior Simulated Divided Lites (SDL):

- Interior bar: 7/8" (22) wide bars
 - Pine bare wood or factory applied white, clear, or designer black finishes to match the interior.
- Exterior straight bar: 7/8" (22) wide bars Ultrex, finish to match exterior
- Exterior radius bar: ABS Hi, HDDB 7/8" (22) wide bars. Finish to match exterior.

NOTE: Direct Glaze Round Top with Wood Grilles and SDL will only align with the default lite cut of the unit it is intended to be muller with.

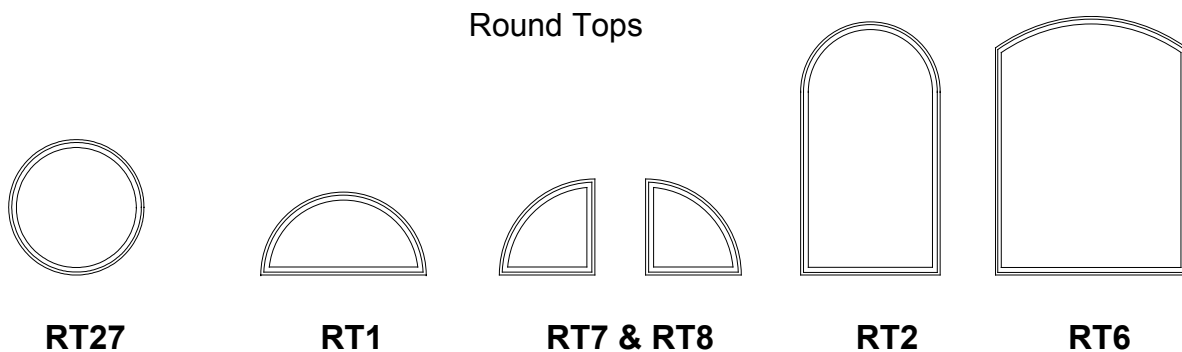

NOTE: Drawings on this page are not to scale.

Wood-Ultrex Impact Round Top

Conversions and Certified Sizes

Unit Measurement		Width		Height	
From	To				
Rough Opening		in	mm	in	mm
Masonry Opening	Rough Opening (RT1, RT2, RT6, RT7/8)	+ 1/2	(13)	+ 1/4	(6)
Masonry Opening	Rough Opening (RT27 - circle)	+ 1/2	(13)	+ 1/2	(13)
OM of Frame	Rough Opening (RT1, RT2, RT6, RT7/8)	+ 1	(25)	+ 1/2	(13)
OM of Frame	Rough Opening (RT27 - circle)	+ 1	(25)	+ 1	(25)
Daylight Opening	Rough Opening (RT1, RT2, RT6, RT7/8)	+ 5	(127)	+ 4 1/2	(114)
Daylight Opening	Rough Opening (RT27 - circle)	+ 5	(127)	+ 5	(127)
Frame		in	mm	in	mm
Daylight Opening	OM of Frame (RT1, RT2, RT6, RT7/8)	+ 4	(102)	+ 4	(102)
Daylight Opening	OM of Frame (RT27 - circle)	+ 4	(102)	+ 4	(102)
Glass		in	mm	in	mm
OM of Frame	Glass (RT1, RT2, RT6, RT7/8)	-3 1/16	(78)	-3 1/16	(78)
OM of Frame	Glass (RT27-circle)	-3 1/16	(78)	-3 1/16	(78)
Daylight Opening	Glass (RT1, RT2, RT6, RT7/8)	+15/16	(24)	+15/16	(24)
Daylight Opening	Glass (RT27-circle)	+15/16	(24)	+15/16	(24)

Product	Air Tested to psf	Water Tested to psf	Certification Rating	Design Pressure	Max Overall FrameWidth		Max Overall FrameHeight	
					in	mm	in	mm
Casement Round Top Impact	1.57	8.35	LC-PG55-FW	+ 55 / - 65	83 1/8	(2111)	83 1/8	(2111)
Casement Round Top Impact	1.57	8.35	LC-PG55-FW	+ 55 / - 65	72 1/16	(1830)	29 9/16	(751)
Double Hung Round Top Impact	1.57	8.35	LC-PG55-FW	+ 55 / - 65	83 1/8	(2111)	83 1/8	(2111)
Double Hung Round Top Impact	1.57	8.35	LC-PG55-FW	+ 55 / - 65	71 1/16	(1805)	29 9/16	(751)

Available Divided Lite Patterns

Divided Lite Options

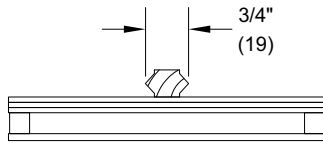

Wood Removable Grille

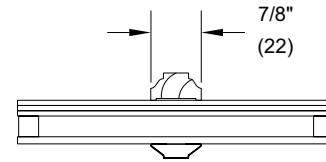

Simulated Divided Lite

Available Divided Lite Patterns

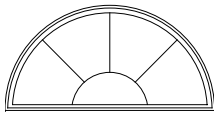

Open Hub, 3 Spokes
 Sunburst Lite Cut
 Wood Grilles or SDL

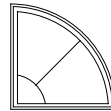

Open Hub, 1 Spoke
 Sunburst Lite Cut
 Wood Grilles or SDL

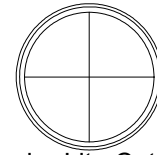

Rectangular Lite Cut 2W2H
 Wood Grilles or SDL

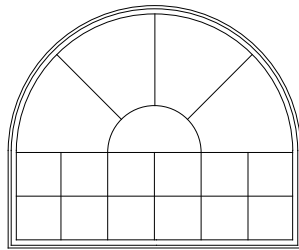
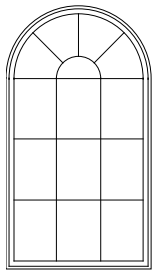

Open Hub, 3 Spokes
 Sunburst Lite Cut
 Wood Grilles or SDL

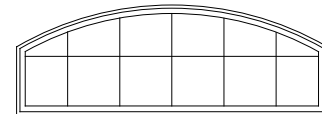
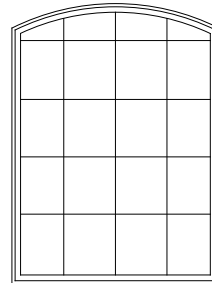

Rectangular Lite Cut
 Wood Grilles or SDL

NOTES:

- IRT: When ordering 6 9/16" (167) or 6 13/16" (173) jamb extensions, add 1/4" (6) to width and 1/8" (3) to height of Frame Size (FS), Rough Opening (RO), and Masonry Opening (MO).
- SDL interior bars are available bare, or with a white, clear, or designer black interior finish. The SDL exterior finish will be determined by the unit exterior finish.
- White, clear, and designer black interior finishes on Grilles, SDLs, and Interior Trim is available at no additional charge.
- White, Clear, and Designer Black interior finishes on Jamb Extensions are available at no additional cost when they match the interior finish of the window. White Jamb Extensions on a unit with a Designer Black interior are available at an additional cost.

Wood-Ultrex Impact Round Top

Section Details: Impact Glazing

Scale: 3" = 1' 0"

Casement

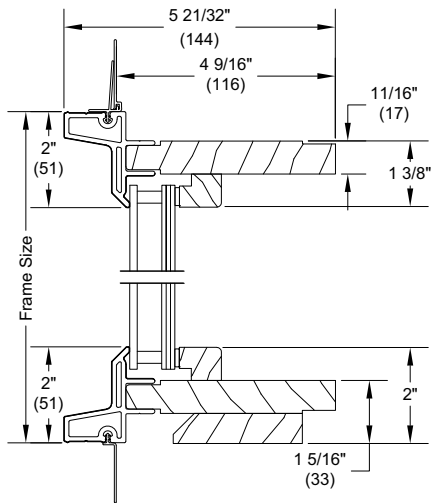

Double Hung

