

# OBSOLETE WOOD AND CLAD GLIDER

## Table of Contents

**NOTICE: Marvin Windows and Doors discontinued the sale of Wood Glider components and Clad Glider Frames on February 27, 2017. Marvin will continue to provide full support for the clad sash, components and glass, as specified by the Marvin warranty.**

	PAGE
<b>Obsolete Wood and Clad Glider</b> .....	2
Wood and Clad Glider History .....	3
<b>Wood Glider</b> .....	4
Wood Glider Parts Identification .....	4
Wood Glider Replacement Parts .....	6
Wood Glider Sash Replacement .....	9
Weather Strip Replacement .....	10
Wood Glider Screen, Energy Panel, Combination Sizing and Replacement Parts .....	11
<b>Clad Glider</b> .....	22
Clad Glider Parts Identification .....	22
Clad Glider Replacement Parts .....	25
Clad Glider Replacement Wood and Aluminum Parts .....	28
Weather Strip Replacement .....	29
Clad Glider Sash Replacement .....	30
Clad Glider Screen, Combination Sizing and Parts .....	31

### **ATTENTION:**

- Specification and technical data are subject to change without notice.
- Numbers listed in parentheses ( ) are metric equivalents in millimeters rounded to the nearest whole number.

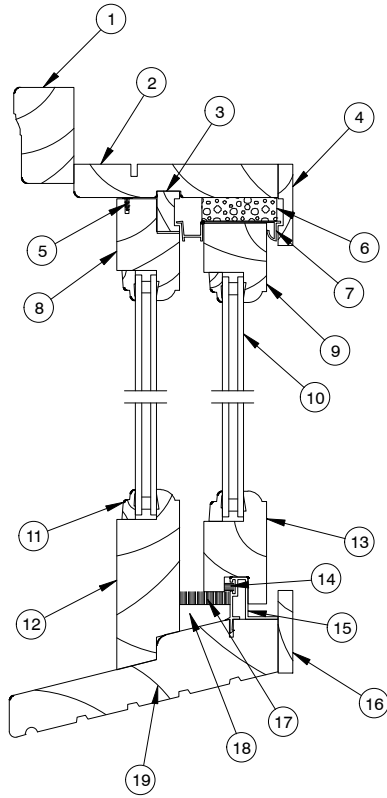
# WOOD AND CLAD GLIDER

**WOOD GLIDER – 1984 TO AUGUST 29, 2011**

**CLAD GLIDER – 1987 TO FEBRUARY 28, 2011**

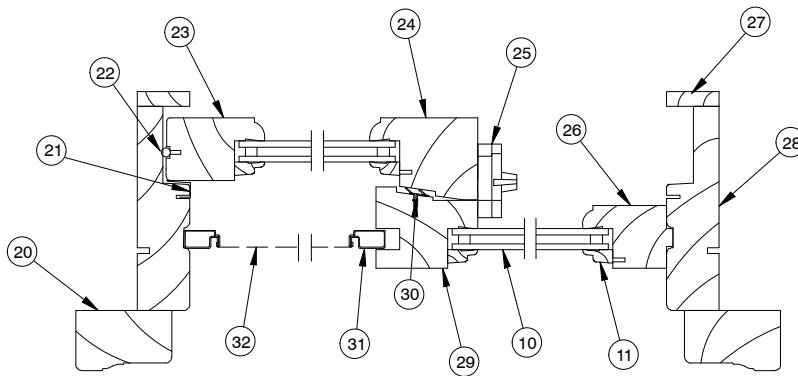
PRODUCED	UNIT TYPE	FEATURES OR CHANGES	DISCONTINUED
Early 1960s	ARB Glider	Unit featured operating, removable sash and extruded aluminum head and sill tracks (spring loaded head tracks individually adjustable). Full screens and routed finger pull standard. All units 40" and 48" in height considered Hi-View and had nylon rollers installed in the sash.	Mid 1970s
1965	E-Z Glide	Unit featured operating, removable sash and rigid vinyl head and sill tracks. Full screens and routed finger pull standard. The head track was spring loaded with adjusting screws controlling track pressure.	Late 1970s
Late 1960s	ARB Single-Glide	Unit featured a removable operator on the left side, right side was direct glazed. Early models used ARB aluminum tracks on both header and sill, later changed to aluminum header track and vinyl sill track.  Brick mould casing later changed to fluted casing.	Early 1970s  1988
Early 1970s	Slider/Single-Glide	Unit features one sliding and one fixed sash; the fixed side is attached to the frame, the sliding sash is removable. Half screen and mousetrap (luggage) lock standard. Vinyl weather stripped tracks utilized on header and sill. Standard 4 9/16" jambs.	Present
1984	Wood Single-Glide	Sash for wood Single-Glide manufactured prior to April 1984 are series 30, after this date series 40 profile. Change in profile resulted in a grille size change and daylight opening change.	Present
1987	Clad Single-Glide	Unit features extruded aluminum exterior with one sliding and one fixed sash, half screen, cam style lock and routed finger pull.  3 9/16" jambs standard.  One lite picture units available.	Present  1992  Present
1988	Wood Single-Glide	Name changed from Single-Glide (slider) to glider. Fluted casing changed to standard profile brick mould casing.	Present
1988	Clad Single-Glide	Name changed from Single-Glide (slider) to glider. Clad sash available with single glazing.  Clad combination introduced.	Present  Early 1992
1992	Wood Glider	Wood simulated divided lite option introduced.	Present
1992	Clad Glider	Standard jamb depth changed to 4 9/16" (3 9/16" jambs still available if specified).	Present
Mid 1992		Combination redesigned.	4/28/97
1993	Clad Glider	Meeting stile weather strip changed from dual leaf to bulb style. Simulated divided lite and factory installed clad brick mould casing options available. Extruded aluminum sill cladding replaced with Ultrex (pultruded fiberglass).	Present
1994	Wood Glider	Mousetrap (luggage) style lock changed to cam style lock.	Present
1997	Clad Glider	New design combination; April 28.	Present
2002	Clad Glider	3/02 Stone White becomes a standard color. Arctic White transitions to a select color.	Present
2003	Wood Glider Clad Glider	3/31/02 Satin Taupe (TP) hardware replaces bronze as standard.	Present
2008	Wood Glider Clad Glider	6/02/2008 Introduced charcoal colored high transparency screen mesh (CH HI-TRAN) as an option on all window and door products (including combinations).	Present
2011	Clad Glider	02/28/2011 Clad Glider Discontinued	02/28/2011
2011	Ultimate Glider	08/29/2011 Wood Glider discontinued	08/29/2011

**WOOD GLIDER  
 OPERATOR**



**HEAD JAMB  
 & SILL DETAIL**

1. Top Brick Mould Casing, W1047
2. Head Jamb
3. Parting Stop, W7130
4. Head Jamb Liner, W7132
5. Stationary Top Rail Weather Strip, V113
6. Head Jamb Track Foam
7. Head Jamb Track, V433
8. Stationary Top Rail
9. Operator Top Rail
10. Insulating Glass
11. Glazing Bead, W4010
12. Stationary Bottom Rail
13. Operator Bottom Rail
14. Sill Track Pile Weather Strip
15. Sill Track, V105
16. Sill Liner, W6240
17. Dust Block Pile Weather Strip
18. Dust Block
19. Sill
20. Side Brick Mould Casing, W1047
21. Jamb Weather Strip, V103
22. Vinyl Bulb Weather Strip, V113
23. Operator Jamb Stile
24. Operator Meeting Stile
25. Lock and Keeper
26. Operator Jamb Stile
27. Jamb Liner, W6150
28. Jamb
29. Meeting Stile Stationary
30. Dual Seal Weather Strip, V116
31. Screen Frame
32. Screen Mesh

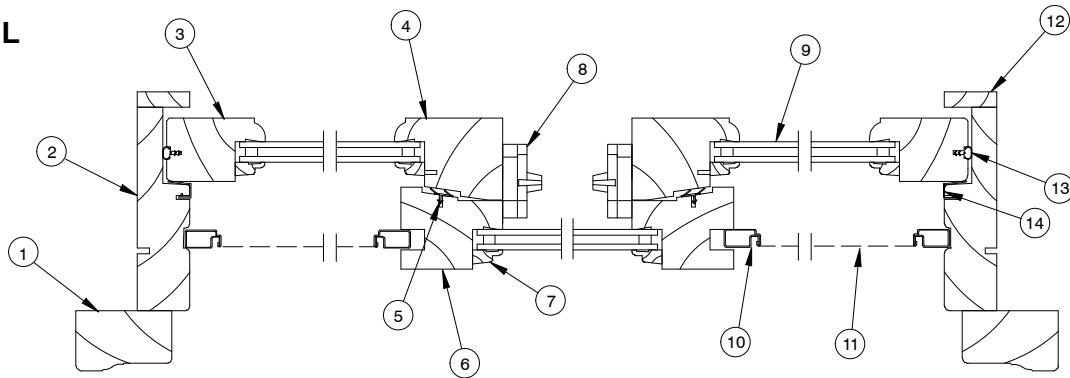


**JAMB  
 DETAIL**

NOTE: Not to scale; specifications subject to change without notice.

**WOOD GLIDER TRIPLE SASH  
XOX OPERATION**

**JAMB  
DETAIL**



- |   |  |
|---|--|
| 1. Brick Mould Casing, W1047                    | 8. Lock                                |
| 2. Jamb   | 9. Insulating Glass                    |
| 3. Operator Stile                               | 10. Screen Frame, A135                 |
| 4. Operator Meeting Stile                       | 11. Screen Mesh                        |
| 5. Stationary Meeting Stile Weather Strip, V116 | 12. Jamb Liner, W6150                  |
| 6. Stationary Meeting Stile                     | 13. Operator Stile Weather Strip, V113 |
| 7. Glazing Bead, W4010                          | 14. Jamb Weather Strip, V103           |

NOTE: Not to scale; specifications subject to change without notice.

When ordering replacement Wood Glider parts specify type of unit, part number and description.

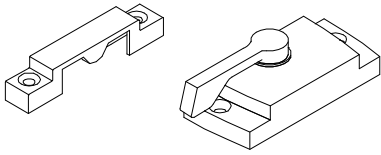
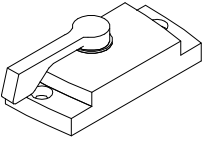
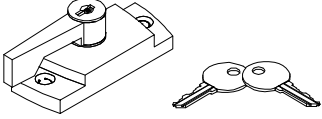
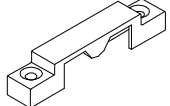
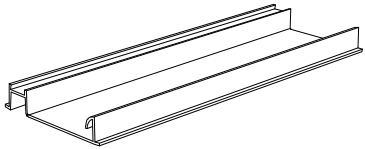
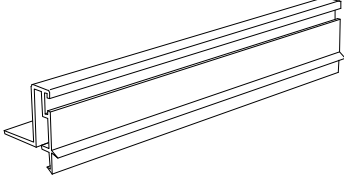

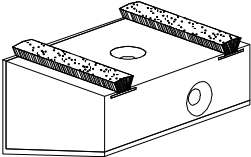
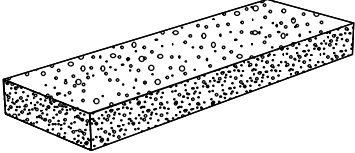
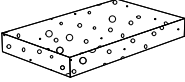
ILLUSTRATION NOT TO SCALE	DESCRIPTION	OPER./ COLOR	PART NO.																					
	<p><b>Sash Lock and Keeper, Complete</b></p> <p><i>Note:</i>  <b>Sash Lock</b>            BS – available in a XO package only  <b>Keeper</b>            BS – available in a XO package only</p>	XO TP OX TP  XO BZ OX BZ  XO WH OX WH  XO BS	11869405 11869406  11869382 11869393  11869383 11869386  05600044																					
	<p><b>Sash Lock</b></p> <p><i>Includes:</i>            1 – Sash lock            2 – #6x1" Phillips flathead wood screws</p>	XO TP OX TP  XO BZ OX BZ  XO WH OX WH	10817045 10817046  10817040 10817041  10840013 10840024																					
	<p><b>Sash Lock, Keyed</b></p> <p><i>Includes:</i>            1 – Keyed lock            2 – Keys            2 – #6x1" Phillips flathead wood screws            Available XO only</p>	TP BZ WH	05590634 05590632 05590633																					
	<p><b>Keeper</b></p> <p><i>Includes:</i>            1 – Keeper            2 – #6x1" Phillips flathead wood screws</p>	TP BZ WH	10817047 10817043 10840014																					
	<p><b>Head Jamb Track, Vinyl</b>            V433</p> <table data-bbox="722 1472 1128 1684"> <tr> <td>CN 16</td> <td>36 7/16"</td> <td>(926)</td> </tr> <tr> <td>CN 20</td> <td>44 7/16"</td> <td>(1129)</td> </tr> <tr> <td>CN 24</td> <td>52 7/16"</td> <td>(1332)</td> </tr> <tr> <td>CN 28</td> <td>60 7/16"</td> <td>(1535)</td> </tr> <tr> <td>CN 32</td> <td>68 7/16"</td> <td>(1738)</td> </tr> <tr> <td>CN 20-40-20</td> <td>85 3/8"</td> <td>(2169)</td> </tr> <tr> <td>CN 20-48-20</td> <td>93 3/8"</td> <td>(2372)</td> </tr> </table>	CN 16	36 7/16"	(926)	CN 20	44 7/16"	(1129)	CN 24	52 7/16"	(1332)	CN 28	60 7/16"	(1535)	CN 32	68 7/16"	(1738)	CN 20-40-20	85 3/8"	(2169)	CN 20-48-20	93 3/8"	(2372)	WH	10431600 10432000 10432400 10432800 10433200 10432040 10432048
CN 16	36 7/16"	(926)																						
CN 20	44 7/16"	(1129)																						
CN 24	52 7/16"	(1332)																						
CN 28	60 7/16"	(1535)																						
CN 32	68 7/16"	(1738)																						
CN 20-40-20	85 3/8"	(2169)																						
CN 20-48-20	93 3/8"	(2372)																						

ILLUSTRATION NOT TO SCALE	DESCRIPTION	OPER./ COLOR	PART NO.
	<b>Sill Track, Vinyl</b> V105  CN 16      36 7/16"    (926) CN 20      44 7/16"    (1129) CN 24      52 7/16"    (1332) CN 28      60 7/16"    (1535) CN 32      68 7/16"    (1738) Lineal      110 13/16" (2815)	WH	10441600 10442000 10442400 10442800 10443200 10442653
	<b>Sash Stop, Vinyl</b> V456 2 1/4" (57)	WH	11860214
	<b>Dust Block Assembly</b> <i>Includes:</i> 1 - Dust block 11867800 1 - PVC foam 10500211 1 - Pile Weather Strip 15607525 2 - #6 x 1 1/2" Phillips flathead wood screws		11867801
	<b>Head Jamb Track Foam</b> 9/16" x 2"	Specify Length	10500007
	<b>Sill Track Gasket</b> 9/16" x 15/16" x 1/8"	WH	10500210

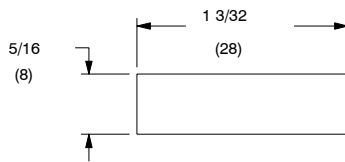


WOOD GLIDER  
**REPLACEMENT WOOD PARTS**

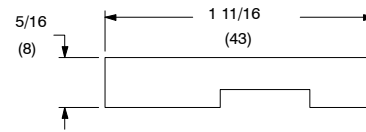
When ordering replacement wood parts specify:

1. profile number;
2. call number or rough opening;
3. length;
4. finish.

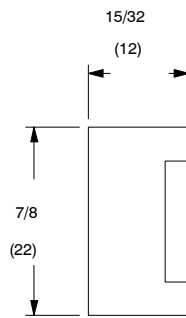
Wood Profile Parts for Wood Glider	
Head Jamb Liner	W7132
Jamb Liner	W6150
Sill Liner	W6240
Parting Stop	W7130



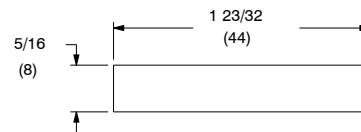
W6150



W7132



W7130



W6240

## ORDERING REPLACEMENT SASH FOR WOOD GLIDER

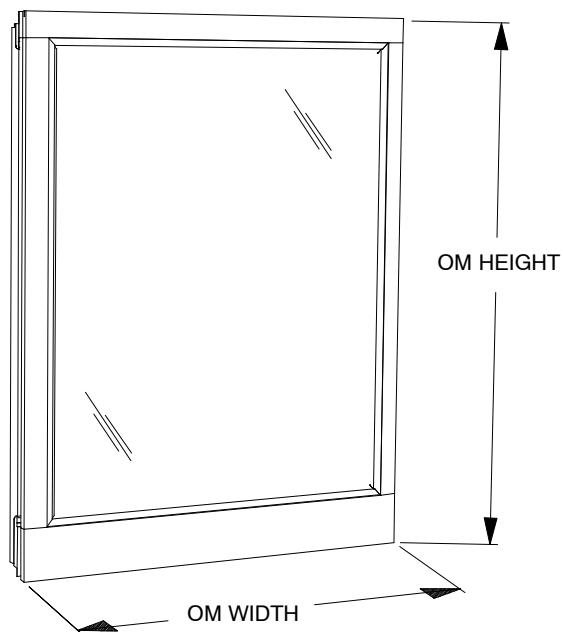
When ordering replacement sash specify:

1. which sash is being replaced – operator or stationary;
2. size (call number or OM of sash);
3. operation (OX or XO);
4. glazing;
5. finish.

## ORDERING REPLACEMENT SASH FOR WOOD TRIPLE SASH UNITS

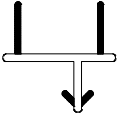


When ordering replacement sash specify:

1. which sash is being replaced – left or right operator or center;
2. size (call number or OM of sash);
3. glazing;
4. finish.



**Wood Stationary Sash  
Exterior View**

When ordering replacement weather strip specify quantity, color, part number and description.

ILLUSTRATION <i>NOT TO SCALE</i>	DESCRIPTION	LENGTH	PART NUMBER
	<b>Dual Leaf Weather Strip, Meeting Stile</b> V116 Color: White	84" (2134)	15828400
	<b>Leaf Weather Strip, Side Jamb</b> V103 Color: White	150" (3810)	15735299
	<b>Pile Weather Strip, Sill Track and Dust Block</b> 1/4" x 1/4" Color: Gray	Specify Length	15607525
	<b>Bulb Weather Strip, Operator Stile and Stationary Top Rail</b> V113 Color: Beige	150" (3810)	15619698

**ORDERING REPLACEMENT SCREENS FOR WOOD GLIDER**

Screens are standard with aluminum surround and charcoal colored fiberglass 18 x 16 screen mesh. Aluminum mesh is available as an option in black, charcoal, bright aluminum or bright bronze. Determine the outside measurement of the existing screen. Find the sizes that correspond to the width and height indicated on the following charts. Surrounds are available in bronze, stone white, brown and pebble gray.

When ordering replacement screen specify:

1. size; – If there is no existing screen from which to obtain the OM of the screen, determine the size of the screen by using the conversion charts below. The daylight opening is the measurement of the visible glass.
2. color;
3. mesh type (if other than standard).

**Screen Sizes for Wood Glider  
manufactured  
1976 to Present**

**Daylight Opening to OM of Screen.**

Daylight Width + 2 = OM Width of Screen

Daylight Height + 5 9/16" = OM Height of Screen

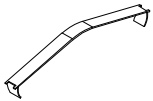
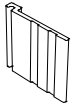
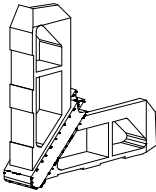

NOTE: Screens feature clear finger pull/leaf spring mounting system.

WIDTH		HEIGHT	
SIZE	OM-WIDTH	SIZE	OM-HEIGHT
CN 16	16 15/16"	CN 16	20 1/2"
CN 20	20 15/16"	CN 24	28 1/2"
CN 24	24 15/16"	CN 28	32 1/2"
CN 28	28 15/16"	CN 32	36 1/2"
CN 32	32 15/16"	CN 36	40 1/2"
		CN 40	44 1/2"
		CN 48	52 1/2"

NOTE: Wood glider triple sash units use a standard CN 20 width screen.

The following parts are used on Glider screens. When ordering replacement parts specify:

1. part number;
2. quantity.

ILLUSTRATION <i>NOT TO SCALE</i>	DESCRIPTION	OPER./C OLOR	PART NO.
	<b>Leaf Spring</b> MISC 0104		11868835
	<b>Finger Pull, Clear</b> V254		11860350
	<b>Corner Key, Screen</b> MISC 051	SW BZ PB/TP BN CL EG	11867875 11867862 11867863 11867864 11867866 11867868
	<b>Screen Surround, Aluminum Profile</b> A135 Available in 150" (3810) length	SW BZ PB BN EG	18801120 15231399 15231150 15231499 15230199

**ORDERING REPLACEMENT ENERGY PANELS FOR WOOD GLIDER**

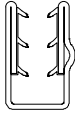
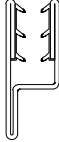

If you are replacing an existing energy panel, determine the outside measurement of the existing energy panel. Find the sizes that correspond to the width and height indicated on the following chart. Energy panels are available for Glider with bronze, stone white, brown or pebble gray aluminum surrounds.

When ordering energy panels specify:

1. size; If there is no existing EP from which to obtain the OM of the panel, determine the size of the EP by using the conversion chart below. The daylight opening is the measurement of the visible glass.
2. color of surround;
3. glass type.

<b>Wood Glider</b>			
<b>Units manufactured early 1970s – Present</b>			
<b>Daylight Opening to OM of EP</b>			
Daylight Width + 1 1/8" = OM Width of EP			
Daylight Height + 1 1/8" = OM Height of EP			
NOTE: OM should not include lip.			
<b>WIDTH</b>		<b>HEIGHT</b>	
<b>SIZE</b>	<b>OM WIDTH</b>	<b>SIZE</b>	<b>OM HEIGHT</b>
CN 16	16 1/16"	CN 16	16 1/16"
CN 20	20 1/16"	CN 24	24 1/16"
CN 24	24 1/16"	CN 28	28 1/16"
CN 28	28 1/16"	CN 32	32 1/16"
CN 32	32 1/16"	CN 36	36 1/16"
		CN 40	40 1/16"
		CN 48	48 1/16"

## ENERGY PANEL SURROUNDS

ILLUSTRATION NOT TO SCALE	DESCRIPTION	OPER./ COLOR	PART NO.
	<b>Energy Panel Surround, Aluminum Profile</b> A155 Jamb stile and bottom rail For single strength glass – 3/32" (2.5) Available in 150" (3810) length	SW 15246299 BZ 15243399 PB 15243299 BN 15243199 AR 15243099	
	<b>Energy Panel Surround, Aluminum Profile</b> A157 Jamb stile and bottom rail For double strength glass – 1/8" (3.0) Available in 150" (3810) length	SW 15246199 BZ 15244299 PB 15244199 BN 15244099 AR 15243999	
	<b>Energy Panel Surround, Aluminum Profile</b> A156 Meeting stile For single strength glass – 3/32" (2.5) Available in 150" (3810) length	SW 15246099 BZ 15243799 PB 15243699 BN 15243599 AR 15243499	
	<b>Energy Panel Surround, Aluminum Profile</b> A158 Meeting stile For double strength glass – 1/8" (3.0) Available in 150" (3810) length	SW 15246399 BZ 15244799 PB 15244699 BN 15244599 AR 15244499	
	<b>Energy Panel Surround, Aluminum Profile</b> A159 Top rail For Single strength glass – 3/32" (2.5) Available in 150" (3810) length	SW 15246499 BZ 15245299 PB 15245199 BN 15245099 AR 15244999	
	<b>Energy Panel Surround, Aluminum Profile</b> A162 Top rail For Double strength glass – 1/8" (3.0) Available in 150" (3810) length	SW 15245999 BZ 15245799 PB 15245699 BN 15245599 AR 15245499	

**ORDERING REPLACEMENT COMBINATIONS AND/OR INSERTS FOR WOOD GLIDER**

Combination units are composed of two glass panels and a screen insert. One of the storm panels slides for self storage when the screen is in use.

When ordering replacement combinations and/or inserts determine the outside measurement of the existing items or use the following conversions if none exists. Use the following charts based on daylight openings to determine combination size and component sizes. Aluminum surround on combinations are available in bronze, stone white, brown and pebble gray. Charcoal colored fiberglass mesh screen is standard. Aluminum mesh screen is available as an option.

When ordering replacement combinations specify:

1. size; – If there is no existing combination from which to obtain the OM of the combination, determine the size of the combination by using the conversion charts below. The daylight opening is the measurement of the visible glass.
2. operation (OX, XO or triple sash);
3. finish and insert color;
4. mesh type (if other than standard);
5. glass type.

**Wood Glider Combination Units**

**Wood Glider units manufactured  
Early 1970s to Present**

**Daylight Opening to OM of  
Combination**

Daylight Width x 2 + 6 1/4" = OM Width  
of Combination

Daylight Height + 6 5/8" = OM Height of  
Combination

<b>Width</b>				
<b>Call Number</b>	<b>Combination OM Width</b>	<b>Stationary Panel OM Width</b>	<b>Operator Panel OM Width</b>	<b>Screen OM Width</b>
CN 16	36 1/8"	15 15/16"	17"	15 11/16"
CN 20	44 1/8"	19 15/16"	21"	19 11/16"
CN 24	52 1/8"	23 15/16"	25"	23 11/16"
CN 28	60 1/8"	27 15/16"	29"	27 11/16"
CN 32	68 1/8"	31 15/16"	33"	31 11/16"
<b>Height</b>				
<b>Call Number</b>	<b>Combination OM Height</b>	<b>Stationary Panel OM Height</b>	<b>Operator Panel OM Height</b>	<b>Screen OM Height</b>
CN 16	21 9/16"	16 1/2"	17 3/16"	16 1/2"
CN 24	29 9/16"	24 1/2"	25 3/16"	24 1/2"
CN 28	33 9/16"	28 1/2"	29 3/16"	28 1/2"
CN 32	37 9/16"	32 1/2"	33 3/16"	32 1/2"
CN 36	41 9/16"	36 1/2"	37 3/16"	36 1/2"
CN 40	45 9/16"	40 1/2"	41 3/16"	40 1/2"
CN 48	53 9/16"	48 1/2"	49 3/16"	48 1/2"

**Triple Sash Units**


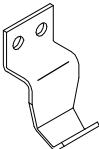
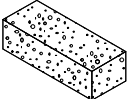
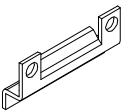
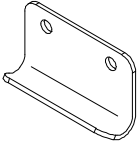
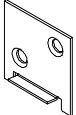
<b>Width</b>				
<b>Call Number</b>	<b>Combination OM Width</b>	<b>Stationary Panel OM Width</b>	<b>Operator Panel OM Width</b>	<b>Screen OM Width</b>
CN 20-40-20	85"	39 15/16"	21" *	19 11/16" *
CN 20-48-20	93"	47 15/16"	21" *	19 11/16" *
<b>Height</b>				
<b>Call Number</b>	<b>Combination OM Height</b>	<b>Stationary Panel OM Height</b>	<b>Operator Panel OM Height</b>	<b>Screen OM Height</b>
CN 32	37 9/16"	32 9/16"	33 3/16" *	32 1/2" *
CN 40	45 9/16"	40 9/16"	41 3/16" *	40 1/2" *
CN 48	53 9/16"	48 9/16"	49 3/16" *	48 1/2" *

\* NOTE: Two operator panels and two screen inserts required per combination.



Combination units are composed of two glass panels and a screen insert. One of the storm panels slides to the side for self storage when the screen is in use.

When ordering specify the quantity, description, color and part number.

ILLUSTRATION NOT TO SCALE	DESCRIPTION	OPER./ COLOR	PART NO.
 <p>Left Hand      Right Hand</p>	<p><b>Turn Latch</b> MISC 062</p> <p>LH RH</p>	<p>Mill Finish</p>	<p>11860411 11860311</p>
	<p><b>Hook, Short</b> MISC 064</p> <p><i>Includes:</i> 1 - Hook 2 - Rivets</p>	<p>Mill Finish</p>	<p>11040200</p>
	<p><b>Pad, Hook</b> M601 3/8"x1/2"x1 5/16"</p>	<p>WH</p>	<p>10500201</p>
	<p><b>Strike, Stationary Panel</b> MISC 065</p> <p><i>Includes:</i> 1 - Strike 2 - Rivets</p>	<p>Mill Finish</p>	<p>11040300</p>
	<p><b>Sash Pull</b> MISC 063</p> <p><i>Includes:</i> 1 - Sash pull 2 - #6x5/16" truss head screws</p>	<p>Mill Finish</p>	<p>03040511</p>
	<p><b>Wood Combination Keeper</b></p>		<p>03060411</p>

When ordering replacement panel track specify:

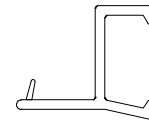
1. profile;
2. call number or OM of combination;
3. length;
4. color;
5. wood or clad unit.



**V392**

**Stationary Panel Track**

Wood stationary vertical  
and horizontal panel  
track

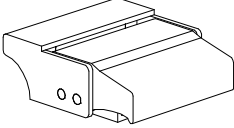
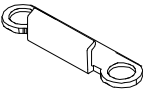
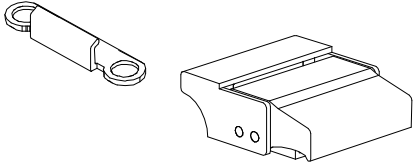
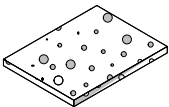


**V057**

**Operator Panel Track**

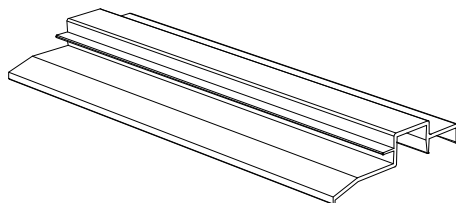
Wood vertical and  
horizontal panel track

When ordering replacement parts specify quantity, part number and description.

ILLUSTRATION NOT TO SCALE	DESCRIPTION	OPER./ COLOR	PART NO.
	<p><b>Mousetrap Lock (Luggage)</b>                      Used between the early 1970s until late 1994  <i>Includes:</i>                      1 - Mousetrap lock                      2 - #7x7/8" Phillips flathead wood screws</p>	BZ WH	NA NA
	<p><b>Keeper, Mousetrap Lock</b>                      Used between the early 1970s until late 1994  <i>Includes:</i>                      1 - Keeper                      2 - #7x7/8" Phillips flathead wood screws</p>	BZ WH	10817032 NA
	<p><b>Mousetrap Lock (Luggage), Complete, Brass</b>                      Used between 1992 and 1994  <i>Includes:</i>                      1 - Mousetrap lock                      1 - Keeper                      4 - #7x7/8" Phillips flathead wood screws</p>	BS	NA
	<p><b>Sill Track Gasket</b>                      1 1/16" x 13/16" x 1/16"</p>	GY	NA Replaced with 10500035

**SILL TRACK**

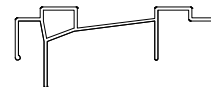
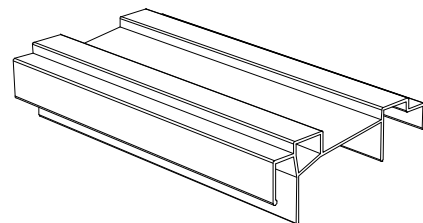
Sill track is no longer available.



**ARB Single-Glide Sill Track**

Used between late 1960s and early 1970s

NOTE: Head jamb track is no longer available.






**ARB E-Z Glide Sill Track**

Used between 1965 and the late 1970s

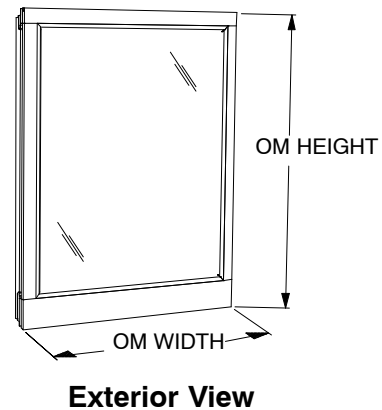
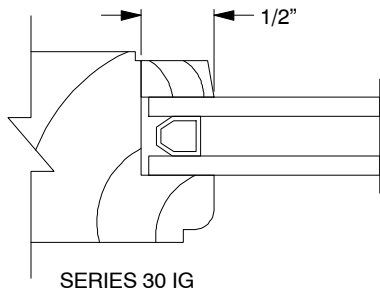
NOTE: Head jamb track is no longer available.

When ordering replacement parts specify quantity, color part number and description.

ILLUSTRATION <i>NOT TO SCALE</i>	DESCRIPTION	LENGTH	PART NUMBER
	<p><b>Bulb Weather Strip,</b> Wood – Operator stile and stationary top rail Clad – Stiles, top rail and head jamb stop filler V113 Color: Beige</p>	150" (3810)	15619698
	<p><b>Offset, Bulb Weather Strip, Operator Stile</b> V157 Used between 1960 and 1991 WH</p>		NA replace with V113
	<p><b>Hinged Leaf Weather Strip, Parting Stop</b> V245 Color: White</p>	84" (2134)	15818400

**ORDERING OBSOLETE REPLACEMENT SASH FOR WOOD GLIDER UNITS**

NOTE: Series 30 sash used on Wood Glider units between 1960 – 1984 is no longer available and must be replaced with the current sash.



**ORDERING REPLACEMENT SCREENS FOR WOOD GLIDER**

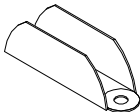
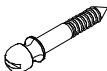

Screens are standard with aluminum surround and charcoal colored fiberglass 18 x 16 screen mesh. Aluminum mesh is available as an option in black, charcoal, bright aluminum or bright bronze. Determine the outside measurement of the existing screen. Find the sizes that correspond to the width and height indicated on the following chart. Surrounds are available in bronze, white, brown and pebble gray.

When ordering replacement screen specify:

1. size; – If there is no existing screen from which to obtain the OM of the screen, determine the size of the screen by using the conversion chart below. The daylight opening is the measurement of the visible glass.
2. color;
3. mesh type (if other than standard).

<b>Wood Glider ARB, E-Z Glide and Hi-View                      manufactured between 1960s to 1978</b> <b>Daylight Opening to OM of Screen.</b>	
NOTE: All screens feature hanger and bail loop mounting system.	
<p style="text-align: center;"><b>ARB and E-Z Glide Single Glaze</b></p> <p>Daylight Width x 2 + 4 7/8" = OM Width of Screen                      Daylight Height + 5 1/2" = OM Height of Screen</p> <p style="text-align: center;"><b>ARB and E-Z Glide Insulating Glass</b></p> <p>Daylight Width x 2 + 5 3/4" = OM Width of Screen                      Daylight Height + 5 15/16" = OM Height of Screen</p>	<p style="text-align: center;"><b>Hi-View Single Glaze</b></p> <p>Daylight Width x 2 + 6 5/8" = OM Width of Screen                      Daylight Height + 5 1/2" = OM Height of Screen</p> <p style="text-align: center;"><b>Hi-View Insulating Glass</b></p> <p>Daylight Width x 2 + 7" = OM Width of Screen                      Daylight Height + 6 11/16" = OM Height of Screen</p>

**OBSOLETE GLIDER SCREEN PARTS**

ILLUSTRATION <i>NOT TO SCALE</i>	DESCRIPTION	OPER./COLO R	PART NO.
	<p><b>Hanger</b>                      Used between 1960s to 1978  <i>Includes:</i>                      1 – Hanger                      1 – #6x5/8" Phillips flathead wood screw</p>		11860031
	<p><b>Ball Drive Screw</b>                      Used between 1960s to 1978</p>		11011005
	<p><b>Loop Latch (Bail Loop)</b>                      Used between 1960s to 1978</p>		11011006

**ORDERING REPLACEMENT COMBINATIONS FOR WOOD GLIDER**

Combination units are composed of two glass panels and a screen insert. One of the storm panels slides to the side for self storage when the screen is in use.

When ordering replacement combinations and/or inserts determine the outside measurement of the existing items or use the following conversions if none exists. Use the following chart based on daylight openings to determine combination sizes. Aluminum surround on combinations are available in bronze, white, brown and pebble gray. Charcoal colored fiberglass mesh screen is standard. Aluminum mesh screen is available as an option.

When ordering replacement combinations specify:

1. type of unit;
2. size; – If there is no existing combination from which to obtain the OM of the combination, determine the size of the combination by using the conversion charts below. The daylight opening is the measurement of the visible glass.
3. finish and insert color;
4. mesh type (if other than standard);
5. glass type.

NOTE: Champagne tone aluminum surround is no longer available.

**Wood Glider Combination Units.**

**Wood Glider ARB, E-Z Glide,  
Hi-View ARB and Senior Glide  
manufactured between 1960s and 1978**

**Daylight Opening to OM of Combination**

**ARB and E-Z Glide Single Glaze**

Daylight Width x 2 + 4 7/8" = OM Width of Combination  
Daylight Height + 5 13/16" = OM Height of Combination

**ARB and E-Z Glide Insulating Glass**

Daylight Width x 2 + 5 3/4" = OM Width of Combination  
Daylight Height + 6 1/4" = OM Height of Combination

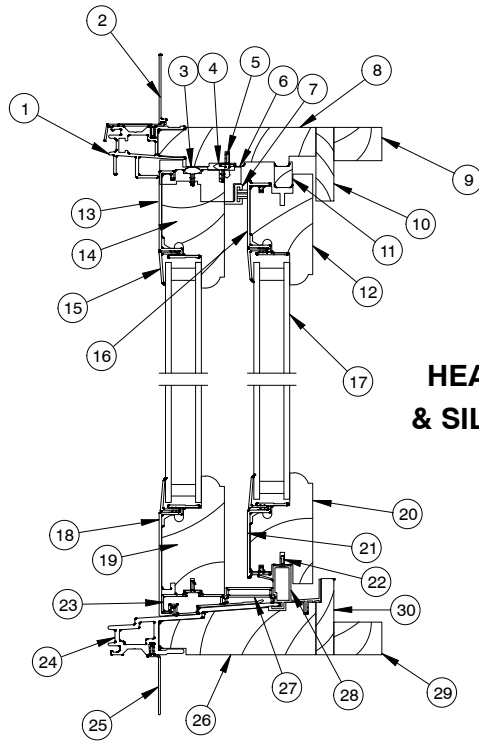
**Hi-View Single Glaze**

Daylight Width x 2 + 6 5/8" = OM Width of Combination  
Daylight Height + 5 13/16" = OM Height of Combination

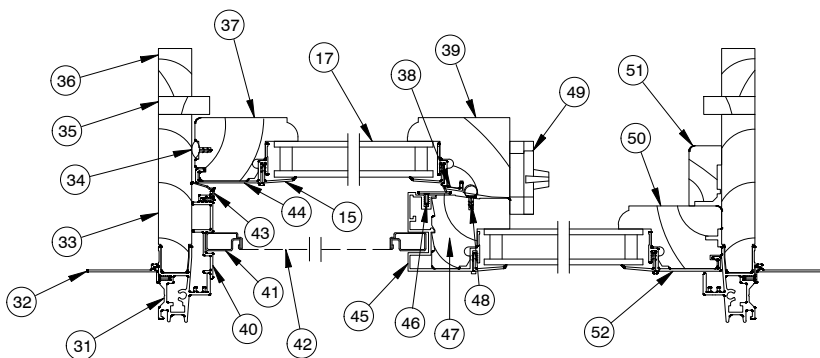
**Hi-View Insulating Glass**

Daylight Width x 2 + 7" = OM Width of Combination  
Daylight Height + 7" = OM Height of Combination

**CLAD GLIDER  
 OPERATOR**



**HEAD JAMB  
 & SILL DETAIL**

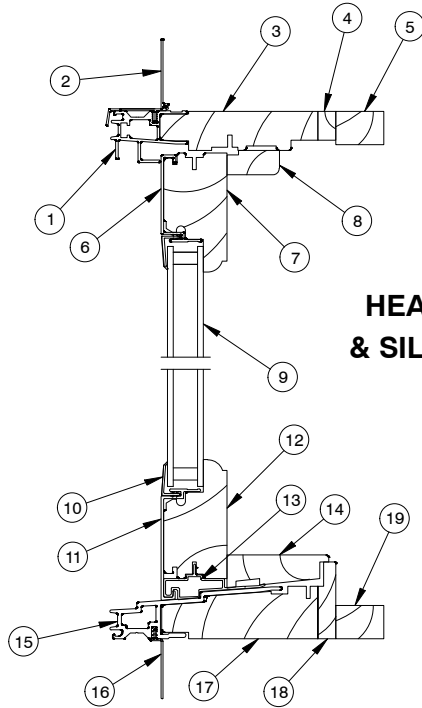


**JAMB  
 DETAIL**

1. Head Jamb Cladding
2. Head Jamb Nailing Fin & Drip Cap, V119
3. Stationary Top Rail Weather Strip, V113
4. Head Jamb Stop-Filler Weather Strip
5. Head Jamb Stationary Stop
6. Head Jamb Stop Filler, W7146
7. Head Jamb Stop-Pile Weather Strip
8. Head Jamb
9. Head Jamb Extension
10. Head Jamb Liner, W6230
11. Sash Stop, W7150
12. Operator Top Rail
13. Stationary Top Rail Cladding
14. Stationary Top Rail
15. Vinyl Glazing Bead, V644
16. Operator Top Rail Cladding
17. Insulating Glass
18. Stationary Bottom Rail Cladding
19. Stationary Bottom Rail
20. Operator Bottom Rail
21. Operator Bottom Rail Cladding
22. Bottom Rail Slide Insert, V230
23. Leveling Block, V658
24. Sill Cladding
25. Sill Nailing Fin, V084
26. Sill
27. Sill Spacer, V643
28. Sill Track, V642
29. Sill Jamb Extension
30. Sill Liner, W7148
31. Jamb Cladding
32. Jamb Nailing Fin, V104
33. Jamb
34. Operator Stile Weather Strip, V113
35. Jamb Liner, W6140
36. Jamb Extension
37. Operator Stile
38. Operator meeting Stile Cladding
39. Operator Meeting Stile
40. Operator Jamb Stop, A204
41. Screen Frame, A135
42. Screen Mesh
43. Jamb Stop Weather Strip, V659
44. Operator Stile Cladding
45. Stationary Meeting Stile Cladding
46. Stationary Meeting Stile-Fin Weather Strip, V647
47. Stationary Meeting Stile
48. Stationary Meeting Stile-Bulb
49. Lock
50. Stationary Stile
51. Stationary Jamb-Inside Stop, W7034
52. Stationary Stile Cladding

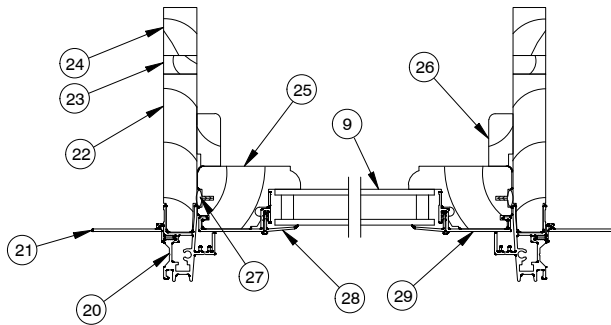
NOTE: Not to scale; specifications subject to change without notice.

**CLAD GLIDER  
 PICTURE UNIT**



**HEAD JAMB  
 & SILL DETAIL**

1. Head Jamb Cladding
2. Head Jamb Nailing Fin & Drip Cap, V119
3. Head Jamb
4. Head Jamb Liner, W6059
5. Head Jamb Extension
6. Top Rail Cladding
7. Top Rail
8. Head Jamb Stop, W7013
9. Insulating Glass
10. Vinyl Glazing Bead, V644
11. Bottom Rail Cladding
12. Bottom Rail
13. Leveling Block, V658
14. Sill Filler, W7142
15. Sill Cladding
16. Sill Nailing Fin, V084
17. Sill
18. Sill Liner, W7148
19. Sill Jamb Extension
20. Jamb Cladding
21. Jamb Nailing Fin, V104
22. Jamb
23. Jamb Liner, W6080
24. Jamb Extension
25. Stile
26. Jamb Stop, W7013
27. Sash Weather Strip, V113
28. Vinyl Glazing Bead, V644
29. Stile Cladding



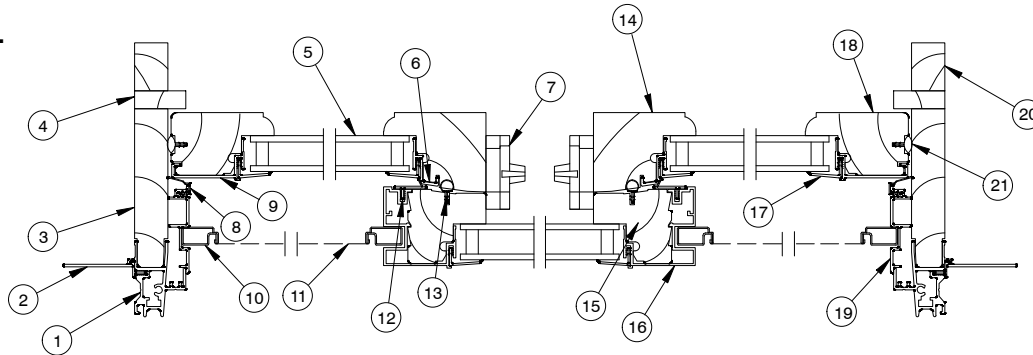
**JAMB  
 DETAIL**

NOTE: Not to scale; specifications subject to change without notice.



**CLAD GLIDER TRIPLE SASH  
 XOX OPERATION**

**JAMB  
 DETAIL**



- |                                    |   |
|------------------------------------|---|
| 1. Jamb Cladding                   | 11. Screen Mesh                                       |
| 2. Jamb Nailing Fin, V104          | 12. Stationary Meeting Stile-Fin Weather Strip, V647  |
| 3. Jamb                            | 13. Stationary Meeting Stile-Bulb Weather Strip, V113 |
| 4. Jamb Liner, W6140               | 14. Operator Meeting Stile                            |
| 5. Insulating Glass                | 15. Stationary Meeting Stile                          |
| 6. Operator Meeting Stile Cladding | 16. Stationary Meeting Stile-Cladding                 |
| 7. Lock                            | 17. Vinyl Glazing Bead, V644                          |
| 8. Jamb Stop Weather Strip, V659   | 18. Operator Stile                                    |
| 9. Operator Stile Cladding         | 19. Operator Jamb Stop, A204                          |
| 10. Screen Frame                   | 20. Jamb Extension                                    |
|                                    | 21. Operator Stile Weather Strip, V113                |

NOTE: Not to scale; specifications subject to change without notice.

When ordering replacement Clad Glider parts specify type of unit, part number and description.

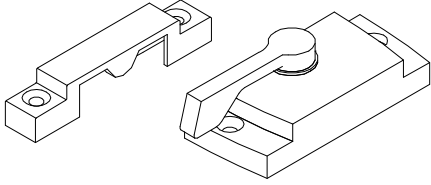
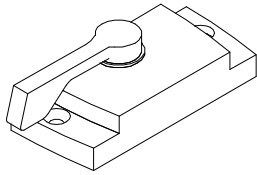
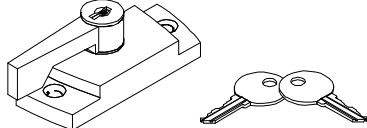
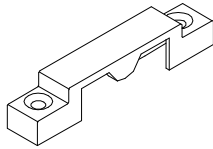
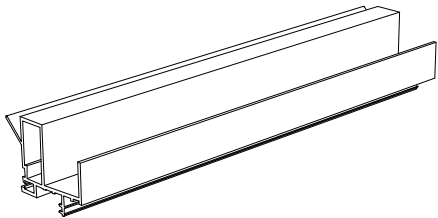
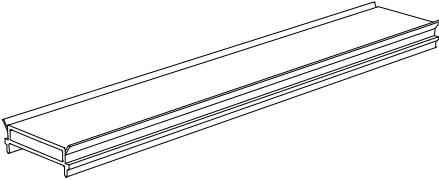
ILLUSTRATION NOT TO SCALE	DESCRIPTION	OPER./ COLOR	PART NO.																		
	<p><b>Sash Lock and Keeper, Complete</b></p> <p><i>Note:</i>  <i>Sash lock</i>  <i>BS—available in XO package only</i>  <i>Keeper</i>  <i>BS—available in XO package only</i></p>	XO TP OX TP  XO BZ OX BZ  XO WH OX WH  XO BS	11869405 11869406  11869382 11869393  11869383 11869386  05600044																		
	<p><b>Sash Lock</b></p> <p><i>Includes:</i>            1 – Sash lock            2 – #6x1" Phillips flathead wood screws</p>	XO TP OX TP  XO BZ OX BZ  XO WH OX WH	10817045 10817046  10817040 10817041  10840013 10840024																		
	<p><b>Sash Lock, Keyed</b></p> <p><i>Includes:</i>            1 – Keyed lock            2 – Keys            2 – #6x1" Phillips flathead wood screws            Available XO only</p>	TP BZ WH	05590634 05590632 05590633																		
	<p><b>Keeper</b></p> <p><i>Includes:</i>            1 – Keeper            2 – #6x1" Phillips flathead wood screws</p>	TP BZ WH	10817047 10817043 10840014																		
	<p><b>Sill Track, Vinyl</b>            V642</p> <table border="0"> <tr> <td>CN 3-0</td> <td>34 1/16"</td> <td>(865)</td> </tr> <tr> <td>CN 4-0</td> <td>46 1/16"</td> <td>(1170)</td> </tr> <tr> <td>CN 5-0</td> <td>58 1/16"</td> <td>(1475)</td> </tr> <tr> <td>CN 6-0</td> <td>70 1/16"</td> <td>(1780)</td> </tr> <tr> <td>CN 8-0</td> <td>94 1/16"</td> <td>(2398)</td> </tr> <tr> <td>Lineal</td> <td>150"</td> <td>(3810)</td> </tr> </table>	CN 3-0	34 1/16"	(865)	CN 4-0	46 1/16"	(1170)	CN 5-0	58 1/16"	(1475)	CN 6-0	70 1/16"	(1780)	CN 8-0	94 1/16"	(2398)	Lineal	150"	(3810)	BG	15619234 15619246 15619258 15619270 15619280 15619299
CN 3-0	34 1/16"	(865)																			
CN 4-0	46 1/16"	(1170)																			
CN 5-0	58 1/16"	(1475)																			
CN 6-0	70 1/16"	(1780)																			
CN 8-0	94 1/16"	(2398)																			
Lineal	150"	(3810)																			
	<p><b>Sill Spacer, Vinyl</b>            V643</p> <table border="0"> <tr> <td>CN 3-0</td> <td>17 1/8"</td> <td>(435)</td> </tr> <tr> <td>CN 4-0</td> <td>23 1/8"</td> <td>(587)</td> </tr> <tr> <td>CN 5-0</td> <td>29 1/8"</td> <td>(740)</td> </tr> <tr> <td>CN 6-0</td> <td>35 1/8"</td> <td>(892)</td> </tr> <tr> <td>CN 8-0</td> <td>48 1/4"</td> <td>(1226)</td> </tr> <tr> <td>Lineal</td> <td>150"</td> <td>(3810)</td> </tr> </table>	CN 3-0	17 1/8"	(435)	CN 4-0	23 1/8"	(587)	CN 5-0	29 1/8"	(740)	CN 6-0	35 1/8"	(892)	CN 8-0	48 1/4"	(1226)	Lineal	150"	(3810)	BG	15619117 15619123 15619129 15619135 15619148 15619199
CN 3-0	17 1/8"	(435)																			
CN 4-0	23 1/8"	(587)																			
CN 5-0	29 1/8"	(740)																			
CN 6-0	35 1/8"	(892)																			
CN 8-0	48 1/4"	(1226)																			
Lineal	150"	(3810)																			

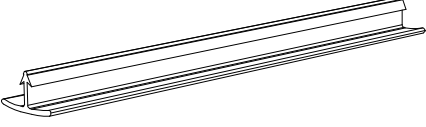
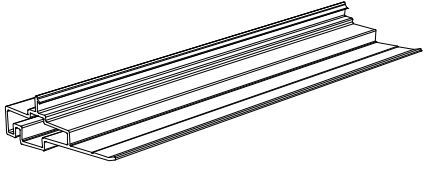

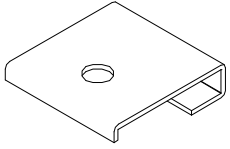
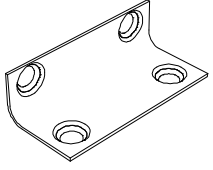
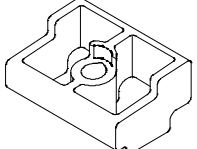
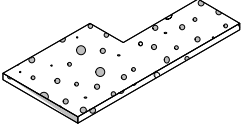
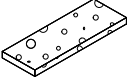
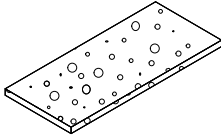
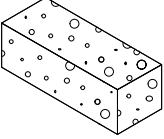
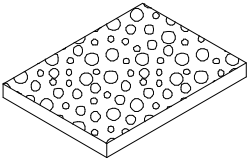
ILLUSTRATION NOT TO SCALE	DESCRIPTION	OPER./ COLOR	PART NO.
	<b>Bottom Rail Slide Insert</b> V230  CN 3-0    17 5/8"    (448) CN 4-0    23 5/8"    (600) CN 5-0    29 5/8"    (752) CN 6-0    35 5/8"    (905) Lineal    144"        (3658)	WH	15619830 15619840 15619850 15619860 15619899
	<b>Leveling Block</b> V658  CN 3-0    17 1/4"    (438) CN 4-0    23 1/4"    (591) CN 5-0    29 1/4"    (743) CN 6-0    35 1/4"    (895) CN 8-0    48 29/32" (1242) Lineal    150"        (3810)	BG	15619017 15619023 15619029 15619035 15619048 15619099
	<b>Head Jamb Stationary Stop</b> V366  CN 3-0    16 1/4"    (413) CN 4-0    22 1/4"    (565) CN 5-0    28 1/4"    (718) CN 6-0    34 1/4"    (870) CN 8-0    46 1/4"    (1175) Lineal    150"        (3810)	BG	16194916 16194922 16194928 16194934 16194946 16195000
	<b>Top Rail Stationary Bracket</b>  <i>Includes:</i> 1 - Bracket 1 - #8 x 1" Phillips flathead wood screw		11860018
	<b>Stationary Bracket, Sash</b> M172  <i>Includes:</i> 1 - Bracket 4 - #7 x 7/8" Phillips flathead wood screws - 11800798		11841000
	<b>Sill Horn Plug</b> MISC 753	CL	11867835

ILLUSTRATION NOT TO SCALE	DESCRIPTION	OPER./ COLOR	PART NO.
	<b>Head Jamb Filler Gasket</b> 1 13/16" x 13/16" x 1/16"	GY	10500214
	<b>Sill Spacer Gasket</b> 1 1/32" x 3/8" x 1/16"	GY	10500216
	<b>Top Rail Stationary Bracket Gasket</b> 1 11/16" x 3/4" x 1/16"	GY	10500217
	<b>Operator Jamb Stop Gasket</b> 1 5/16" x 1/2" x 7/16"	WH	10500218
	<b>Foam Pad for Dust Block and Sill Track Ends</b> 1 3/32" x 13/16" x 3/32"	GY	10500035

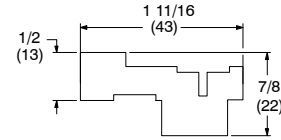
## TO ORDER REPLACEMENT PARTS

When ordering replacement parts specify:

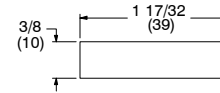
1. profile number;
2. call number or rough opening;
3. length;
4. finish.

Wood and Aluminum Profile Parts for Clad Glider	
Head Jamb Stop Filler	W7146
Head Jamb Liner	W6230
Jamb Extension 1"	W6120
Jamb Liner	W6140
Sill Liner	W7148
Sash Stop	W6065
Sash Limiting Block (Optional)	W7151
Operator Sash Guide	W7150
Stationary Jamb Inside Stop	W7034
Operator Jamb Stop Cladding	A204
Head Jamb Stop Cladding	A203

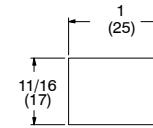
Picture Units	
Head Jamb Liner, Picture	W6059
Head Jamb and Jamb Stop, Picture	W7013
Jamb Liner, Picture	W6080
Sill Filler, Picture	W7142
3W Center Picture Stationary Hardware Cover (contact your Marvin Representative to order)	W8025



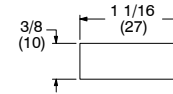
W7146



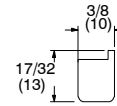
W6230



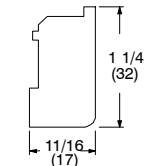
W6120



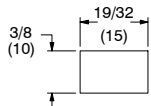
W6140



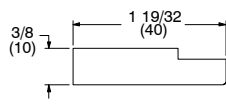
W7150



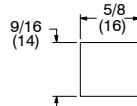
W7034



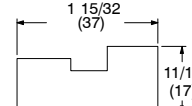
W6059



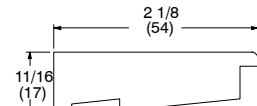
W7148



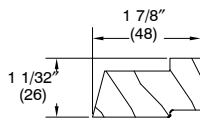
W6065



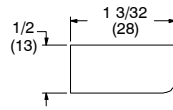
W7151



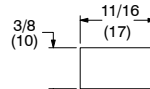
W7142



W8025



W7013



W6080



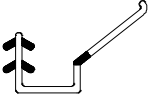
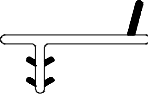
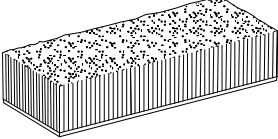
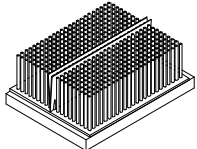


A204



A203

**ORDERING REPLACEMENT WEATHER STRIP FOR GLIDER**

When ordering replacement weather strip specify quantity, color, part number and description.

ILLUSTRATION NOT TO SCALE	DESCRIPTION	LENGTH	PART NUMBER
	<b>Hinged Leaf Weather Strip, Jamb Cover</b> V659 Color: Beige	100" (2540)	15619499
	<b>Fin Weather Strip, Stationary Meeting Stile</b> V647 Color: Beige	150" (3810)	15619599
	<b>Dust Plug, Head Jamb</b> 1 1/4" x 1 3/4" x 1/2" Color: Beige		15600513
	<b>Dust Plug, Meeting Stile</b> 3/4" x 15/16" x 5/16" Color: Beige		10500036
	<b>Dust Plug, Sill</b> <i>Includes:</i> 1 - Dust Block - 10500036 1 - Foam Pad - 10500035		11867803
	<b>Bulb Weather Strip, Stiles, Top Rail and Head Jamb Stop Filler</b> V113 Color: Beige	150" (3810)	15619698
	<b>Pile Weather Strip, Head Jamb Stop Cladding</b> 1/4" x 1/4" Color: Gray	Specify Length	15607525

**ORDERING REPLACEMENT SASH FOR CLAD GLIDER**

When ordering replacement sash specify:

1. which sash is being replaced – operator or stationary;
2. size (call number or OM of sash);
3. operation (OX or XO);
4. glazing;
5. finish.

**ORDERING REPLACEMENT SASH FOR CLAD TRIPLE SASH UNITS**

When ordering replacement sash specify:

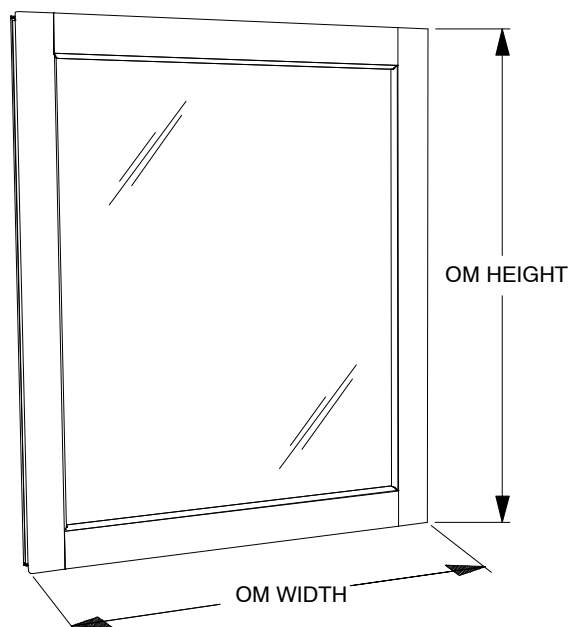
1. which sash is being replaced – left or right operator or center;
2. size (call number or OM of sash);
3. glazing;
4. finish.

NOTE: Replacement center sash for XOX and stationary sash on XO/OX units are shipped with the leveling block and new weather strip.

**ORDERING REPLACEMENT SASH FOR CLAD GLIDER PICTURE UNITS**

When ordering replacement sash specify:

1. size (call number or OM of sash);
2. glazing;
3. finish.



**Clad Stationary Sash  
Exterior View**

**ORDERING REPLACEMENT SCREENS FOR CLAD GLIDER**

Screens are standard with aluminum surround and charcoal colored fiberglass 18 x 16 screen mesh. Aluminum mesh is available as an option in black, charcoal, bright aluminum or bright bronze. Determine the outside measurement of the existing screen. Find the sizes that correspond to the width and height indicated on the following charts. Surrounds are available in bronze, stone white, brown and pebble gray.

When ordering replacement screen specify:

1. size; – If there is no existing screen from which to obtain the OM of the screen, determine the size of the screen by using the conversion charts below. The daylight opening is the measurement of the visible glass.
2. color;
3. mesh type (if other than standard).

**Screen Sizes for Clad Glider  
manufactured  
1987 to Present**

**Daylight Opening to OM of Screen.**

Daylight Width + 2 1/16" = OM Width of Screen

Daylight Height + 4 7/8" = OM Height of Screen

NOTE: Screens feature clear finger pull/leaf spring mounting system.

WIDTH		HEIGHT	
SIZE	OM-WIDTH	SIZE	OM-HEIGHT
CN 30	15 7/8"	CN 20	21 5/16"
CN 40	21 7/8"	CN 30	33 5/16"
CN 50	27 7/8"	CN 36	39 5/16"
CN 60	33 7/8"	CN 40	45 5/16"
		CN 50	57 5/16"

NOTE: Clad Glider triple sash units use a standard CN 40 width screen.



**ORDERING REPLACEMENT COMBINATIONS AND/OR INSERTS FOR CLAD GLIDER**

Combination units are composed of two glass panels and a screen insert. One of the storm panels slides to the side for self storage when the screen is in use.

When ordering replacement combinations and/or inserts use the outside measurement of the existing items or the following conversions. Use the following charts based on daylight openings to determine combination and component sizes. Aluminum surround on combinations are available in bronze, stone white, brown, pebble gray and evergreen. Charcoal aluminum wire screen is standard.

When ordering replacement combinations specify:

1. size; – If there is no existing combination from which to obtain the OM of the combination, determine the size of the combination by using the conversion charts below. The daylight opening is the measurement of the visible glass.
2. operation (OX, XO or triple sash);
3. color;
4. mesh type (if other than standard);
5. glass type.

**Clad Glider Combination Units**

<p><b>Clad Glider units Manufactured 4/28/97 to Present</b></p> <p><b>Daylight Opening to OM of Combination</b></p> <p>Daylight Width x 2 + 6 17/32" = OM Width of Combination</p> <p>Daylight Height + 5 5/8" = OM Height of Combination</p>
---

Width				
Call Number	Combination OM Width	Stationary Panel OM Width	Operator Panel OM Width	Screen OM Width
CN 3-0	34 5/32"	16 3/8"	15 5/16"	15 5/16"
CN 4-0	46 5/32"	22 3/8"	21 5/16"	21 5/16"
CN 5-0	58 5/32"	28 3/8"	27 5/16"	27 5/16"
CN 6-0	70 5/32"	34 3/8"	33 5/16"	33 5/16"
Height				
Call Number	Combination OM Height	Stationary Panel OM Height	Operator Panel OM Height	Screen OM Height
CN 2-0	22 1/16"	19 3/16"	19 3/16"	19 3/16"
CN 3-0	34 1/16"	31 3/16"	31 3/16"	31 3/16"
CN 3-6	40 1/16"	37 3/16"	37 3/16"	37 3/16"
CN 4-0	46 1/16"	43 3/16"	43 3/16"	43 3/16"
CN 5-0	58 1/16"	55 3/16"	55 3/16"	55 3/16"

**Triple Sash Units**

Width				
Call Number	Combination OM Width	Stationary Panel OM Width	Operator Panel OM Width	Screen OM Width
CN 8-0	94 5/32"	49 1/4"	21 11/16" *	21 5/16" *
Height				
Call Number	Combination OM Height	Stationary Panel OM Height	Operator Panel OM Height	Screen OM Height
CN 2-0	22 1/16"	19 3/16"	19 3/16" *	19 3/16" *
CN 3-0	34 1/16"	31 3/16"	31 3/16" *	31 3/16" *
CN 3-6	40 1/16"	37 3/16"	37 3/16" *	37 3/16" *
CN 4-0	46 1/16"	43 3/16"	43 3/16" *	43 3/16" *
CN 5-0	58 1/16"	55 3/16"	55 3/16" *	55 3/16" *

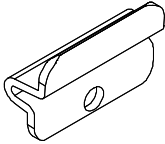
\* NOTE: Two operator panels and two screen inserts required per combination.

**ORDERING REPLACEMENT COMBINATIONS AND/OR INSERTS FOR CLAD GLIDER**

Combination units are composed of two glass panels and a screen insert. One of the storm panels slides to the side for self storage when the screen is in use.

When ordering replacement combinations specify:

1. part number
2. quantity

<b>ILLUSTRATION</b> <i>NOT TO SCALE</i>	<b>DESCRIPTION</b>	<b>OPER./ COLOR</b>	<b>PART NO.</b>
	<b>Mounting Clip</b> MISC 454	Clear	11867855

## ORDERING REPLACEMENT COMBINATIONS AND/OR INSERTS FOR CLAD GLIDER

Combination units are composed of two glass panels and a screen insert. One of the storm panels slides to the side for self storage when the screen is in use.

When ordering replacement combinations and/or inserts determine the outside measurement of the existing items or use the following conversions if none exists. Use the following charts based on daylight openings to determine combination size and component sizes. Aluminum surround on combinations are available in bronze, white, brown and pebble gray. Charcoal aluminum wire screen is standard. Fiberglass mesh screen is available as an option.

When ordering replacement combinations specify:

1. size; – If there is no existing combination from which to obtain the OM of the combination, determine the size of the combination by using the conversion charts below. The daylight opening is the measurement of the visible glass.
2. operation (OX, XO or triple sash);
3. color;
4. mesh type (if other than standard);
5. glass type.

### Clad Glider Combination Units

**Clad Glider units  
manufactured May 1987 to  
early 1992**

**Daylight Opening to OM of  
Combination**

Daylight Width x 2 + 6 1/2" = OM Width  
of Combination

Daylight Height + 5 11/16" = OM Height  
of Combination

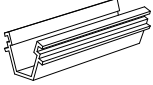
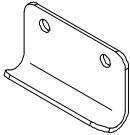
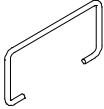
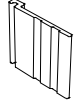
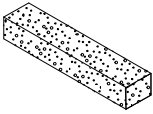
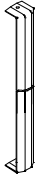
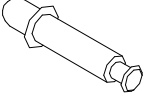

Width				
Call Number	Combination OM Width	Stationary Panel OM Width	Operator Panel OM Width	Screen OM Width
CN 3-0	34 1/8"	15 3/32"	16 1/4"	15 3/32"
CN 4-0	46 1/8"	21 3/32"	22 1/4"	21 3/32"
CN 5-0	58 1/8"	27 3/32"	28 1/4"	27 3/32"
CN 6-0	70 1/8"	33 3/32"	34 1/4"	33 3/32"
Height				
Call Number	Combination OM Height	Stationary Panel OM Height	Operator Panel OM Height	Screen OM Height
CN 2-0	22 1/8"	19 1/4"	19 15/16"	19 5/16"
CN 3-0	34 1/8"	31 1/4"	31 15/16"	31 5/16"
CN 3-6	40 1/8"	37 1/4"	37 15/16"	37 5/16"
CN 4-0	46 1/8"	43 1/4"	43 15/16"	43 5/16"
CN 5-0	58 1/8"	55 1/4"	55 15/16"	55 5/16"

Triple Sash Unit Width				
Call Number	Combination OM Width	Stationary Panel OM Width	Operator Panel OM Width	Screen OM Width
CN 8-0	94 1/8"	46 7/8"	22 1/4" *	21 3/32" *
Triple Sash Unit Height				
Call Number	Combination OM Height	Stationary Panel OM Height	Operator Panel OM Height	Screen OM Height
CN 2-0	22 1/8"	19 5/16"	19 15/16" *	19 5/16" *
CN 3-0	34 1/8"	31 5/16"	31 15/16" *	31 5/16" *
CN 3-6	40 1/8"	37 5/16"	37 15/16" *	37 5/16" *
CN 4-0	46 1/8"	43 5/16"	43 15/16" *	43 5/16" *
CN 5-0	58 1/8"	55 5/16"	55 15/16" *	55 5/16" *

\* NOTE: Two operator panels and two screen inserts required per combination.

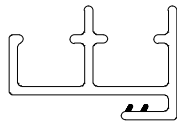
Combination units are composed of two glass panels and a screen insert. One of the storm panels slides to the side for self storage when the screen is in use.

When ordering replacement parts specify quantity and part number.

ILLUSTRATION NOT TO SCALE	DESCRIPTION	OPER./ COLOR	PART NO.
	<b>Sash Stop Clip, Vinyl</b> V456 1 3/4" (44)	WH	11860134
	<b>Sash Pull</b> MISC 063 <i>Includes:</i> 1 - Sash pull 2 - #6x5/16" truss head screws	Mill Finish	03040511
	<b>Wire Lift Handle, Stainless Steel</b> MISC 455		11040301
	<b>Finger Pull</b> V254 Replaces black finger pull	Clear	11860350
	<b>Foam Pad</b> 3/8"x1/2"x1 7/16"	WH	N/A
	<b>Center Bar (Pre 1997)</b> A461 <i>Includes:</i> 1 - Center bar 2 - #6x3/8" Fillister Head screws  NOTE: Specify CN or height of combination	BZ AR BN PB EG	18507399 NA 18507199 18507299 18507499
	<b>Combination Screen Pin</b>	Clear	11867852
	<b>Pan Head Screw</b> #8x3/4"	BZ AR BN PB EG	11800838 11800835 11800836 11800837 11800839

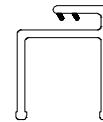
When ordering replacement panel track specify:

1. profile;
2. call number or OM of combination;
3. length;
4. color;
5. wood or clad unit.

**V662**

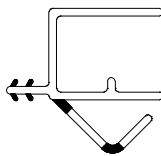
**Operator and Stationary  
Screen Panel Track**

Clad horizontal bottom track  
**No Longer Available**

**V661**

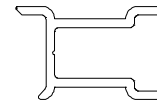
**Operator and Stationary  
Panel Track**

Clad horizontal top track  
**No Longer Available**

**V660**

**Operator Panel Track**

Clad vertical track  
**No Longer Available**

**A463**

**Center Spacer**

Clad vertical spacer